

HEWLETT  PACKARD

OPERATING AND SERVICE MANUAL

8620C
SWEEP OSCILLATOR
INCLUDES OPTION 001,
OPTION 011, AND OPTION 908.

SERIAL NUMBERS

This manual applies directly to instruments with serial numbers prefixed 1716A.

With changes described in Section VII, this manual also applies to instruments with serial numbers prefixed 1645A, 1641A, 1626A, 1604A, 1542A, and 1537A.

For additional important information about serial numbers see INSTRUMENT COVERED BY MANUAL in Section I.

© Copyright

HEWLETT-PACKARD COMPANY

1977

1400 FOUNTAIN GROVE PARKWAY, SANTA ROSA, CALIFORNIA 95404, U.S.A.

MANUAL PART NO. 08620-90093

Microfiche Part No. 08620-90094

Operating Information Supplement Part No. 08620-90093

Printed: OCTOBER 1977

CONTENTS

Section	Page	Section	Page
I GENERAL INFORMATION	1-3	2-44. Environment	2-9
1-1. Introduction	1-3	2-46. Packaging	2-9
1-6. Specifications	1-3	III OPERATION	3-1
1-8. Safety Considerations	1-3	3-1. Introduction	3-1
1-9. General	1-3	3-3. Panel Features	3-1
1-11. Safety	1-3	3-5. Operator's Check	3-1
1-12. Instruments Covered by Manual	1-6	3-7. Operating Instructions	3-1
1-17. Description	1-6	3-9. Safety	3-1
1-20. Full Sweep Mode	1-6	3-12. Remote Programming	3-6
1-22. Marker Sweep Mode	1-6	3-14. Computer or Calculator Programming	3-6
1-24. ΔF Sweep Mode	1-6	3-17. Hewlett-Packard Interface Bus (HP-IB)	3-6
1-26. CW Mode	1-7	3-19. Manual Remote Programming	3-6
1-28. Options	1-7	3-21. HP-IB Remote Programming Instructions	3-6
1-32. Accessories Supplied	1-7	3-23. Interface Modes of Operation	3-6
1-35. Accessory Kit	1-7	3-26. Mode Selection	3-6
1-37. Equipment Required But Not Supplied	1-7	3-33. Band Programming	3-7
1-39. Equipment Available	1-7	3-36. Frequency (Voltage) Programming	3-8
1-40. Service Accessories	1-7	3-44. Markers	3-9
1-42. Model 8410B/8411A Network Analyzer	1-7	3-47. Format Statements	3-9
1-44. Power Meters and Crystal Detectors	1-7	3-51. HP 8620C HP-IB Configuration Code	3-9
1-46. HP-IB Equipment	1-10	3-53. Remote/Local Operation	3-9
1-47. Recommended Test Equipment	1-10	3-58. Addressing	3-11
1-49. 8620C Option 001 Description	1-10	3-61. Listen Address Codes	3-11
1-51. HP-IB General Information	1-10	3-65. Unaddressing	3-11
1-54. Three-Wire Handshake Description	1-10	3-67. Response Timing Consideration	3-11
II INSTALLATION	2-1	3-69. Bus Operating Considerations	3-12
2-1. Introduction	2-1	3-72. Operator's Maintenance	3-12
2-3. Initial Inspection	2-1	3-74. Fuses	3-12
2-5. Preparation For Use	2-1	3-76. Air Filter	3-12
2-6. Power Requirements	2-1	3-78. Lamp Replacement	3-12
2-8. Line Voltage Selection	2-1	3-80. Frequency Scale Installation	3-12
2-10. Power Cable	2-1	IV PERFORMANCE TESTS	4-1
2-12. Interconnections	2-1	4-1. Introduction	4-1
2-14. Mating Connectors	2-4	4-3. Equipment Required	4-1
2-16. Operating Environment	2-4	4-5. Test Results	4-1
2-20. Cooling	2-4	4-7. Full Sweep Test	4-1
2-22. Bench Operation	2-4	4-8. Marker Sweep Test	4-1
2-24. Rack Mounting (Option 908)	2-4	4-9. CW Operation Test	4-2
2-26. Frequency Scale Installation	2-4	4-10. CW Vernier Test	4-2
2-28. Model 8620C HP-IB Interface (Option 011) Installation	2-5	4-11. ΔF Sweep Test	4-3
2-29. Interface Connectors and Cables	2-5	4-12. Sweep Time Adjust and Stop Sweep Test (HP Model 86290A Only)	4-6
2-31. Cable Length Restrictions	2-5	4-13. Amplitude Modulation Test	4-7
2-33. HP-IB Interface Assembly	2-7	4-14. Blanking Outputs Test	4-8
2-35. Address Switch	2-8	4-15. Triggered Sweep Test	4-11
2-37. HP-IB/Model 8410B Network Analyzer Installation	2-8	4-16. Frequency Markers Test	4-12
2-39. Installation for Additional Interface Capabilities	2-8	4-17. Digital-to-Analog Converter Test (Option 001)	4-14
2-41. Verification	2-9	4-18. Model 8620C Performance Test Using HP-IB Option 001	4-15
2-43. Storage and Shipment	2-9		

CONTENTS (Cont'd)

Section	Page	Section	Page
V ADJUSTMENTS	5-1	6-5. Replaceable Parts List	6-1
5-1. Introduction	5-1	6-8. Ordering Instructions	6-1
5-3. Equipment Required	5-1	VII MANUAL BACKDATING CHANGES	7-1
5-5. Safety Considerations	5-1	7-1. Introduction	7-1
5-11. Related Adjustments	5-1	7-5. Manual Change Instructions	7-1
5-13. Adjustment Locations	5-1	VIII SERVICE	8-1
5-15. Power Supply Adjustments	5-3	8-1. Introduction	8-1
5-16. Fan Adjustments	5-4	8-3. Assembly Service Sheets	8-1
5-17. 1 kHz Modulation Adjustment	5-5	8-5. Principles of Operation	8-1
5-18. Sweep Generator Board Adjustments	5-5	8-6. Circuit Description	8-1
5-19. Full Sweep Adjustment	5-7	8-8. Service	8-1
5-20. Start Marker/Stop Marker Adjustment	5-7	8-9. Safety	8-1
5-21. Marker Sweep Adjustment	5-8	8-13. Troubleshooting	8-1
5-22. CW/CW Marker Adjustment	5-8	8-16. Recommended Test Equipment	8-2
5-23. CW Vernier Adjustment	5-9	8-18. Repair	8-2
5-24. ΔF Adjustment	5-9	8-19. Service Accessories	8-2
5-25. Digital-to-Analog Converter Adjustment (Option 001 Only)	5-10	8-21. Cleaning Switches	8-2
5-26. Digital-to-Analog Converter Adjustment (Option 011 Only)	5-10	8-24. Front Panel Disassembly	8-2
5-27. Mechanical Zero Adjustment	5-12	8-29. Restringing Pointer Belts	8-3
VI REPLACEABLE PARTS	6-1	8-31. Maintenance	8-3
6-1. Introduction	6-1	8-32. Fuses	8-3
6-3. Abbreviations	6-1	8-34. Air Filter	8-4
		8-36. Lamp Replacement	8-4

ILLUSTRATIONS

Figure	Page	Figure	Page
1-1. Model 8620C Sweep Oscillator with Accessories Supplied	1-0	2-7. HP-IB Connector/Adaptor 08620-60130, Pin Configuration	2-7
1-2. Model 8620C Option 001 Equipment Supplied	1-1	2-8. Address Switch A12SW1	2-8
1-3. Model 8620C Option 011 Equipment Supplied	1-2	2-9. HP-IB/8410B Installation	2-9
1-4. Typical Serial Number Plate	1-6	2-10. Installation for Additional Interface Capabilities	2-10
1-5. Service Accessories, HP Part Number 08620-60124	1-8	2-11. 8620C Cable Adapter for Additional Interface Capabilities	2-11
1-6. HP Model 8410B Auto-Frequency Mode Interface Cable	1-9	2-12. HP-IB Verification Program (HP 9830A Calculator)	2-12
1-7. Interface Connections and Bus Structure	1-12	2-13. HP-IB Verification Program (HP 9825A Calculator)	2-13
2-1. Line Voltage Selection with Power Module PC Board	2-2	3-1. Front Panel Controls, Connectors, and Indicators	3-2
2-2. AC Power Cables Available	2-3	3-2. Rear Panel Controls and Connectors	3-4
2-3. Preparation for Rack Mounting	2-5	3-3. Lamp Replacement	3-17
2-4. Location of Mainframe Parts Pertinent to Frequency Scale and RF Plug-In Installation	2-6	3-4. Operator's Check	3-18
2-5. Mainframe Front Panel in Open Position	2-6	3-5. Full Sweep Mode	3-21
2-6. HP-IB Interface Cable	2-7	3-6. Marker Sweep Mode	3-23

ILLUSTRATIONS (Cont'd)

Figure	Page	Figure	Page
3-7. CW Operating Mode	3-25	8-4. Location of Pointer Belts	8-6
3-8. ΔF Sweep Mode	3-27	8-5. Pointer Belt Restranging Diagrams	8-7
4-1. CW Vernier Test Setup	4-2	8-6. General Information on Schematic Diagrams	8-8
4-2. ΔF Sweep Test Setup	4-4	8-7. Schematic Diagram Notes	8-9
4-3. Sweep Time Adjust and Stop Sweep Test Setup	4-6	8-8. IC Logic Symbol Configuration Details	8-12
4-4. Sequential Sweep Ramp Compared in Time to Negative Blanking	4-7	8-9. Functional Block Diagram	8-13
4-5. Amplitude Modulation Test Setup	4-8	8-10. A1 Sweep Generator Assembly, Component Locations (1 of 2)	8-15
4-6. Display Blanking and RF Blanking Test Setup	4-9	8-11. A1 Sweep Generator Assembly, Schematic (1 of 2)	8-15
4-7. Typical Display with No Blanking	4-10	8-12. A1 Sweep Generator Assembly, Component Locations (2 of 2)	8-17
4-8. Typical Display with RF Blanking	4-10	8-13. A1 Sweep Generator Assembly, Schematic (2 of 2)	8-17
4-9. Typical Display with Display Blanking	4-10	8-14. A2 Frequency Control Assembly, Component Locations	8-19
4-10. Negative and Positive Blanking Test Setup	4-10	8-15. A2 Frequency Control Assembly, Schematic	8-19
4-11. Negative Blanking at J5 Compared in Time to Sweep Output at J1	4-11	8-16. A3 Logic Assembly, Component Locations	8-21
4-12. Positive Blanking at J8 Compared in Time to Sweep Output at J1	4-11	8-17. A3 Logic Assembly, Schematic	8-21
4-13. Triggered Sweep Test Setup	4-12	8-18. A4 +20V and +5V Regulator Assembly, Component Locations	8-23
4-14. Frequency Markers Test Setup	4-13	8-19. A4 +20V and +5V Regulator Assembly, Schematic	8-23
4-15. Typical Display with Amplitude Markers	4-14	8-20. A5 -10V and -40V Regulator Assembly, Component Locations	8-25
4-16. Typical Display with Intensity Markers	4-14	8-21. A5 -10V and -40V Regulator Assembly, Schematic	8-25
4-17. Digital-to-Analog Converter Test Setup	4-14	8-22. A6 BCD Programming Assembly, Component Locations (Option 001)	8-27
4-18. HP-IB Performance Test Setup for FILE 2	4-16	8-23. A6 BCD Programming Assembly, Schematic (Option 001)	8-27
4-19. HP-IB Performance Test Setup for FILE 4	4-16	8-24. A12 HP-IB Interface Assembly, Component Locations (Option 011)	8-29
5-1. Adjustment Test Setup	5-3	8-25. A12 HP-IB Interface Assembly, Schematic (Option 011)	8-29
5-2. Oscilloscope Display of Fan Waveforms	5-5	8-26. Hall Effect Generator Description	8-30
5-3. Oscilloscope Display of Waveform Symmetry	5-6	8-27. A7 Operations Control Assembly, Component Locations	8-31
5-4. D/A Converter Adjustment Test Setup	5-11	8-28. A7 Operations Control Assembly, Schematic	8-31
5-5. Mechanical Zero Adjustment Locations	5-13	8-29. A8 Rectifier Assembly, Component Locations	8-33
5-6. Location of Test Points	5-15	8-30. A8 Rectifier Assembly, Schematic	8-33
5-7. Location of Adjustments	5-15	8-31. A9 Switch Assembly, Component Locations	8-35
6-1. Front Panel Assembly, Parts Locations	6-17	8-32. A9 Switch and A10 Front Interconnect Assembly, Schematic (1 of 2)	8-35
6-2. Cabinet Parts	6-18	8-33. A10 Front Interconnect Assembly, Component Locations	8-37
7-1. A1 Sweep Generator Assembly, Component Locations (CHANGE C)	7-4	8-34. A9 Switch and A10 Front Interconnect Assembly, Schematic (2 of 2)	8-37
7-2. A1 Sweep Generator Assembly, Component Locations (CHANGE C)	7-5	8-35. A11 Motherboard, Component Locations	8-39
7-3. A7 Operations Control Assembly, Component Locations (CHANGE D)	7-6	8-36. A11 Motherboard Interconnect Diagram	8-39
7-4. P/O Figure 8-28. A7 Operations Control Assembly, Schematic (CHANGE D)	7-7	8-37. Rear Panel Wiring Diagram	8-41
7-5. Location of Test Points (P/O Change G)	7-8		
7-6. A7 Operations Control Assembly, Component Locations (P/O Change G)	7-9		
8-1. Removing Hinged Front Panel Assembly From Mainframe	8-5		
8-2. Removing Dial Frame From Front Panel	8-5		
8-3. Removal and Disassembly of A9 Switch Assy and A10 Front Interconnect Assy	8-6		

ILLUSTRATIONS (Cont'd)

Figure	Page	Figure	Page
8-38. Top View, Major Assembly and Component Locations	8-43	8-39. Bottom View, Major Assembly and Component Locations	8-43

TABLES

Table	Page	Table	Page
1-1. Specifications	1-4	3-8. Programming Connector Commands and Signals Available for Additional Interface Capabilities	3-17
1-2. Recommended Test Equipment	1-11	4-1. BCD Inputs and Corresponding Frequency Outputs	4-15
1-3. Glossary of HP-IB Terms, Relating to 8620C	1-13	5-1. Controls Listed and Adjustment Sequence	5-2
2-1. Model 8620C Mating Connectors	2-4	6-1. Reference Designations and Abbreviations	6-2
3-1. Program Modes	3-7	6-2. Replaceable Parts	6-4
3-2. Band Programming (All Modes)	3-8	6-3. Code List of Manufacturers	6-16
3-3. Frequency (Voltage) Programming (Modes M1, M2, M4)	3-8	7-1. Manual Changes by Serial Number	7-1
3-4. Summary of Programming Codes	3-10	8-1. Service Sheet Cross-Reference	8-2
3-5. Listen Address Codes	3-12		
3-6. Remote Programming Using Standard 8620C	3-13		
3-7. Remote Programming Using 8620C Option 001	3-15		



HP 8620C

ACCESSORY KIT
08620C-60123

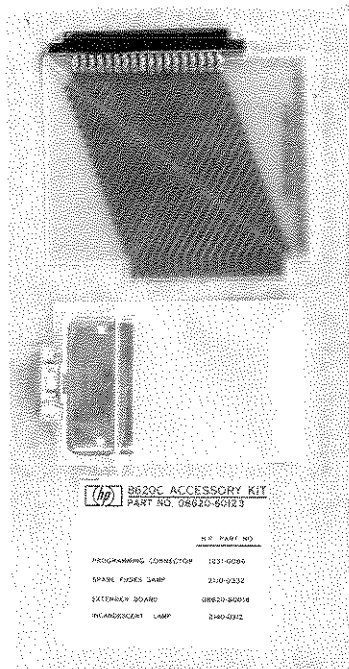

POWER CABLE*

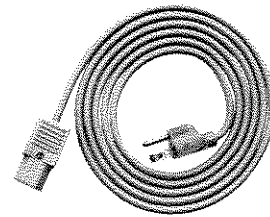

CALIBRATION SCALE
08620-00021



*Power cable/plug supplied depends on country of destination. Refer to Figure 2-2 for part number information.

Figure 1-1. Model 8620C Sweep Oscillator with Accessories Supplied

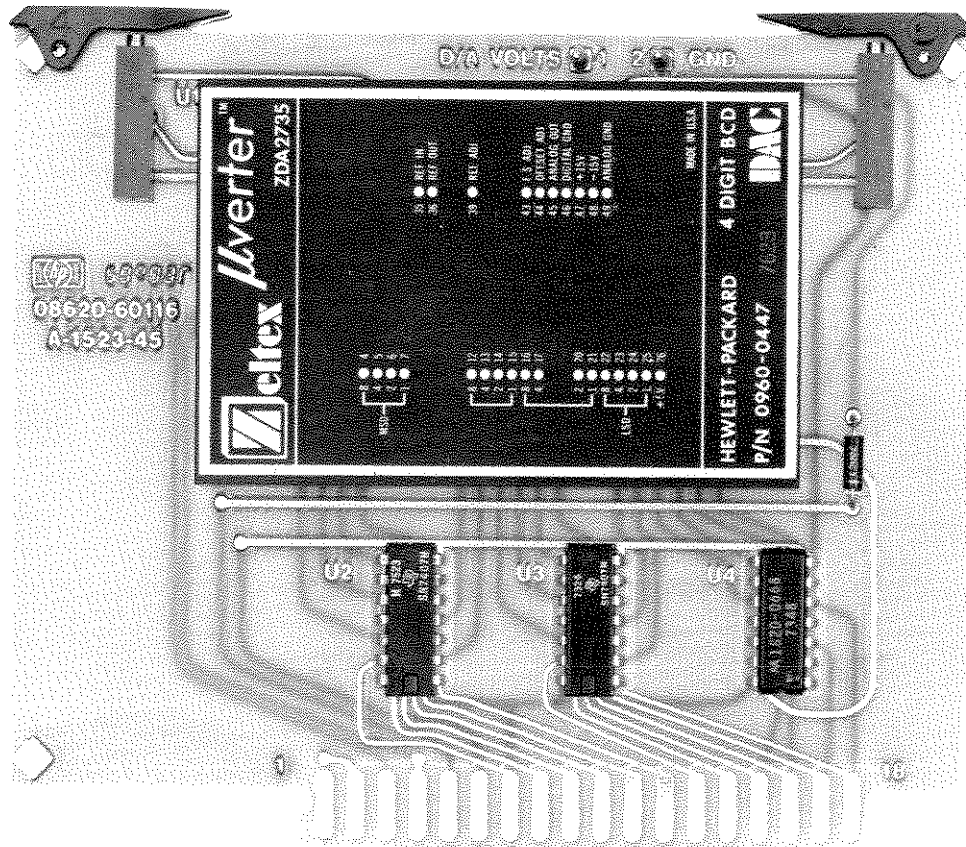

BCD PROGRAMMING ASSEMBLY

08620-60116

Figure 1-2. Model 8620C Option 001 Equipment Supplied

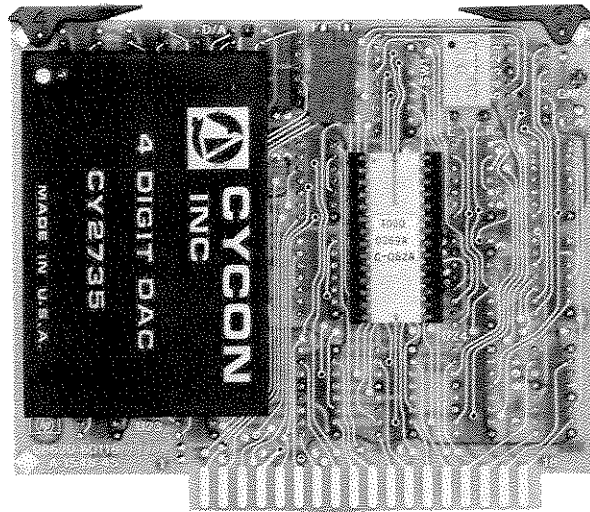

HP-IB INTERFACE ASSEMBLY
08620-60118

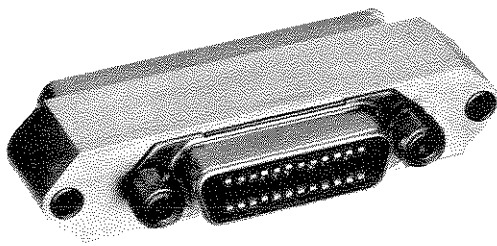

HP-IB CONNECTOR/ADAPTER
08620-60130

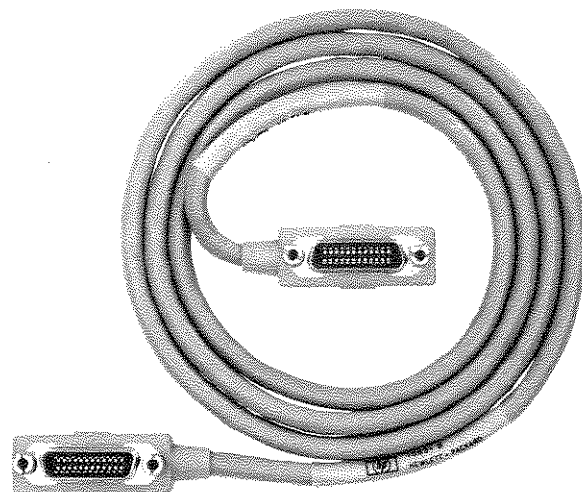

HP-IB INTERCONNECT CABLE
HP 10631B

Figure 1-3. Model 8620C Option 011 Equipment Supplied

SECTION I GENERAL INFORMATION

1-1. INTRODUCTION

1-2. This Operating and Service manual contains information required to install, operate, test, adjust, and service the Hewlett-Packard Model 8620C Sweep Oscillator mainframe. (See Figure 1-1.) An electronically-tuned sweep signal source is made up either by the combination of the Model 8620C and an RF Plug-in, or the combination of the Model 8620C with an RF Section and appropriate oscillator modules. Operating and Service information for the RF Plug-ins, RF Sections, and oscillator modules is contained in separate manuals.

1-3. This manual is divided into eight sections which provide information as follows:

- a. SECTION I, GENERAL INFORMATION, contains the instrument description and specifications as well as the accessory and recommended test equipment list.
- b. SECTION II, INSTALLATION, contains information relative to receiving inspection, preparation for use, mounting, packing, and shipping.
- c. SECTION III, OPERATION, contains operating instructions for the instrument.
- d. SECTION IV, PERFORMANCE TESTS, contains information required to verify that instrument performance is in accordance with published specifications.
- e. SECTION V, ADJUSTMENTS, contains information required to properly adjust and align the instrument after repair.
- f. SECTION VI, REPLACEABLE PARTS, contains information required to order all parts and assemblies.
- g. SECTION VII, MANUAL CHANGES, contains backdating information to make this manual compatible with earlier equipment configurations.
- h. SECTION VIII, SERVICE, contains descriptions of the circuits, schematic diagrams, parts location diagrams, and block diagrams to aid the user in maintaining the instrument.

1-4. Supplied with this manual is an Operating Information Supplement. The Supplement is a copy of the first three sections of this manual, and should be kept with the instrument for use by the operator.

1-5. Also listed on the title page of this manual is a Microfiche part number. This number can be used to order 4 x 6-inch microfilm transparencies of the manual. Each microfiche contains up to 60 photo-duplicates of the manual pages. The microfiche package also includes the latest Manual Changes supplement as well as all pertinent Service Notes.

1-6. SPECIFICATIONS

1-7. Listed in Table 1-1 are the instrument specifications. These specifications are the performance standards, or limits against which the instrument may be tested.

1-8. SAFETY CONSIDERATIONS

1-9. General

1-10. This product and related documentation must be reviewed for familiarization with safety markings and instructions before operation. This product has been manufactured and tested in accordance with international safety standards.

1-11. Safety Symbols



Instruction manual symbol: the apparatus will be marked with this symbol when it is necessary for the user to refer to the instruction manual in order to protect the apparatus against damage.



Indicates dangerous voltages.



Earth terminal.

WARNING

The WARNING sign denotes a hazard. It calls attention to a procedure, practice, or the like, which, if not correctly performed or adhered to, could result in injury or loss of life. Do not proceed beyond a WARNING sign until the indicated conditions are fully understood and met.

CAUTION

The CAUTION sign denotes a hazard. It calls attention to an operating procedure, practice, or the like, which, if not correctly performed or adhered to, could result in damage to or destruction of part or all of the equipment. Do not proceed beyond a CAUTION sign until the indicated conditions are fully understood and met.

Table 1-1. Specifications (1 of 2)

**SPECIFICATIONS
8620C SWEEP OSCILLATOR
(with RF Section or RF Plug-in installed)**

FREQUENCY

Frequency Range: Determined by band select lever and RF Plug-in installed.

Frequency Linearity: Refer to RF unit specifications.

SWEEP FUNCTIONS

FULL Sweep: Sweeps the full band as determined by plug-in and band select lever.

MARKER Sweep: Sweeps from START MARKER to STOP MARKER frequency settings.

Range: Both settings continuously and independently adjustable over the entire frequency range; can be set to sweep either up or down in frequency.

End-point Accuracy: Refer to RF unit specifications, same as frequency accuracy.

ΔF Sweep: Sweeps symmetrically upward in frequency, centered on CW setting. SW Vernier can be activated for fine control of center frequency.

Width: Continuously adjustable and calibrated from zero to 1%, zero to 10%, or zero to 100% of usable frequency band as selected with front-panel switch. Scale calibrated directly in MHz.

Width Accuracy: $\pm 1\%$ of maximum ΔF plus $\pm 2\%$ of ΔF being swept.

Center-Frequency Accuracy: Refer to RF unit specifications, same as frequency accuracy.

Frequency Markers: Three constant-width frequency markers are fully calibrated and independently adjustable over the entire range of FULL SWEEP; the markers are controlled by the START MARKER, STOP MARKER, and CW MARKER controls. In ΔF Sweep, Start and Stop Markers are available; in MARKER SWEEP, the CW Marker is available. A front panel switch provides for selection of either amplitude or intensity markers (amplitude modulating the RF output or Z-axis modulating the CRT display).

Accuracy: Refer to RF unit specifications, same as frequency accuracy.

Resolution: Better than 0.25% of RF unit bandwidth.

Marker Output: Rectangular pulse, typically -5 volts peak, available from Z-axis BNC connector or rear panel. Source impedance, approximately 1000 ohms.

CW Operation: Single-frequency RF output, adjusted by CW Marker control and activated by pressing CW pushbutton.

CW Vernier: Calibrated directly in MHz about CW setting. CW Vernier activated by pressing CW VERNIER pushbutton. Zero to $\pm 0.5\%$ or zero to $\pm 5\%$ of full bandwidth, selectable with front panel switch.

Accuracy: Refer to RF unit specifications, same as frequency accuracy.

Preset Frequencies: START MARKER, STOP MARKER, and ΔF end points in MANUAL and CW MARKER frequency, can be used as preset CW frequencies.

Table 1-1. Specifications (2 of 2)

SWEEP MODES

Auto: Sweep recurs automatically.

Manual: Front-panel control provides continuous manual adjustment of frequency between end frequencies set in any sweep function.

External: Sweep is controlled by external signal applied to rear-panel PROGRAMMING connector. Zero volts at start of sweep increasing linearly to approximately +10V at end of sweep.

SWEEP TRIGGERS

Line: Sweep can be synchronized with ac power line.

Internal: Sweep is controlled by internally generated trigger.

External Trigger: Sweep is actuated by external trigger signal applied to rear-panel EXT TRIGGER BNC connector. Trigger signal must be greater than +2 Vdc, wider than 0.5 μ sec, and not greater than 1 MHz in frequency.

Single: Activated by front-panel switch.

Sweep Time: Continuously adjustable in four decade ranges typically .01 to 100 seconds.

Sweep Output: Direct-coupled sawtooth, zero to approximately +10V, concurrent with swept RF output. Zero volts at start of sweep, approximately +10V at end of sweep regardless of sweep width or direction. In CW mode, dc output is proportional to frequency.

MODULATION

Internal AM: 1000 Hz square-wave modulation on all sweep times (internally adjusted from 950 to 1050 Hz). On/Off ratio, refer to RF unit specifications.

External AM: Refer to RF unit specifications.

External FM: Refer to RF unit specifications.

Phase Lock: Refer to RF unit specifications.

GENERAL

RF Blanking: With RF blanking switch enabled, RF is automatically turned off during retrace, and turned on after completion of retrace. On automatic sweeps, RF is on long enough before sweep starts to stabilize

external circuits and equipment whose response is compatible with the selected sweep rate.

Display and Negative Blanking Outputs: Direct-coupled rectangular pulses of approximately +5V (Display Blanking) and approximately -5V (Negative Blanking) into 2500 ohms available at rear-panel Z-AXIS/MKR/PEN LIFT and NEGATIVE BLANKING connectors, respectively. Both pulses are coincident with RF Blanking pulse.

Pen Lift: For use with X-Y graphic recorders having positive power supplies only. Pen lift terminals available at rear panel PROGRAMMING connector or rear-panel Z-AXIS/MKR/PEN LIFT connector. Available only on slowest sweep speed.

Furnished: 229 cm (7½-foot) power cable with NEMA plug, and accessory kit.

Power: 100, 120, 220, and 240 Vac +5% -10%, 50 to 400 Hz. Approximately 140 watts.

Dimensions: 425 mm wide, 132.6 mm high, 33.7 mm deep (16¼" x 5-1/8" x 13¼").

Weight (not including RF unit): Net, 11.1 kg (24 lb). Shipping, 13.4 kg (30 lb).

**OPTION 001 and OPTION 011
REMOTE FREQUENCY PROGRAMMING****Functions:**

Band: Manual enable or remote control of four bands.

Mode: Seven modes; including digital-frequency control in three modes, with resolution of 10,000 points across full band or between START MARKER and STOP MARKER as set by front-panel controls, or across ΔF as set by front-panel ΔF and CW controls; or selection of any of four analog sweep functions: ΔF or MARKER SWEEP with end points set by appropriate front-panel controls, CW as set by CW MARKER control, or FULL SWEEP of band selected.

Frequency: Resolution of 10,000 points per band.

Marker (Option 011 only): With analog sweeps (FULL SWEEP, ΔF , or MARKER SWEEP), a programmable marker is available in either amplitude (AMPL) or intensity (INTEN) as selected with front-panel switch.

1-12. INSTRUMENTS COVERED BY MANUAL

1-13. Attached to the instrument is a serial number plate. (A typical serial number plate is shown in Figure 1-4.) The serial number is in two parts. The first four digits and letter are the serial number prefix; the last five digits are the suffix. The prefix is the same for all identical instruments; it changes only when a change is made to the instrument. The suffix, however, is assigned sequentially and is different for each instrument. The contents of the manual apply to instruments with the serial number prefix(es) listed under SERIAL NUMBERS on the title page.

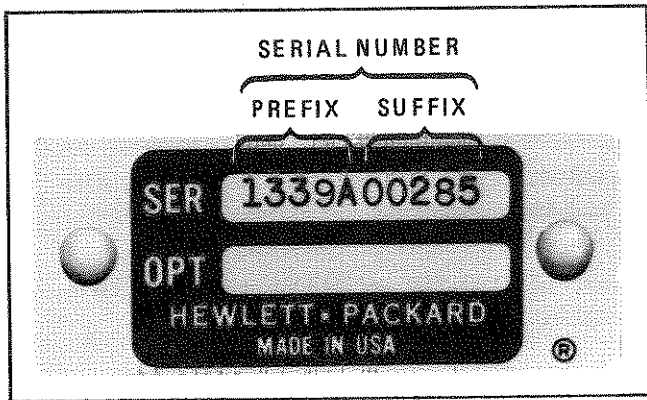

Figure 1-4. Typical Serial Number Plate

1-14. An instrument manufactured after the printing of this manual may have a serial number prefix that is not listed on the title page. This unlisted serial number prefix indicates the instrument is different from those described in this manual. The manual for this newer instrument is accompanied by a yellow Manual Changes supplement. This supplement contains "change information" that explains how to adapt the manual to the newer instrument.

1-15. In addition to change information, the supplement may contain information for correcting errors in the manual. To keep this manual as current and accurate as possible, Hewlett-Packard recommends that you periodically request the latest Manual Changes supplement. The supplement for this manual is identified with this manual's print date and part number, both of which appear on the manual's title page. Complimentary copies of the supplement are available from Hewlett-Packard.

1-16. For information concerning a serial number prefix that is not listed on the title page or in the manual Changes supplement, contact your nearest Hewlett-Packard office.

1-17. DESCRIPTION

1-18. The Hewlett-Packard Model 8620C Sweep Oscillator, together with either an RF Section and oscillator modules, or an RF plug-in forms a completely solid-state self-contained multiband swept signal source. The Model 8620C is designed for use with network analyzer systems such as the 8410B/8411A to provide a complete microwave measurement system. Other systems can also be built, using the Model 8620C as a swept signal source.

1-19. The front panel is designed for simplicity and ease of operation. It is hinged to the mainframe to facilitate changing of the frequency dial. Pressing a mode control selects the mode and causes the lamp in the control to light providing a positive identification of the mode selected.

1-20. Full Sweep Mode

1-21. Full Sweep mode is selected automatically when the mainframe is turned on. In this mode, three markers are available for frequency identification. One marker is adjusted by the CW MARKER control. When ΔF Sweep is selected, this CW Marker setting becomes the center frequency of the ΔF Sweep. The other two markers are adjusted by the START MARKER and STOP MARKER controls. The position of these two markers becomes the start/stop frequencies of the sweep when MARKER SWEEP mode is selected. These two markers are also available on the ΔF Sweep and again become the start/stop frequencies of the sweep when MARKER SWEEP is selected.

1-22. Marker Sweep Mode

1-23. When Marker Sweep mode is selected, one marker is available (controlled by CW MARKER) and its position identifies the center frequency of the ΔF Sweep. The Marker Sweep start/stop frequencies are determined by the position of the start and stop markers on the trace in Full Sweep or ΔF Sweep modes.

1-24. ΔF Sweep Mode

1-25. When ΔF Sweep mode is selected, the CW mode lamp is also lit and the center frequency is adjusted by the CW MARKER control. The ΔF control selects the full-width about the CW frequency. Start and stop markers are available in ΔF Sweep and become the start/stop frequencies of the Marker Sweep.

1-26. CW Mode

1-27. A single-frequency RF output is selected in CW operation. The frequency is selected by adjusting the CW MARKER control. Pressing the CW VERNIER control provides a vernier function for precise frequency adjustment around the CW setting.

1-28. OPTIONS

1-29. Option 001 provides remote programming of mode, band and frequency. The frequency may be selected at 10,000 points through each band by a 16-line BCD input.

1-30. Option 011 provides the HP-IB capability for remote programming. It provides remote programming of mode, band, frequency, and a remote marker. Frequency may be selected at 10,000 points through each band.

1-31. For maximum utility in automatic systems the 8620C is programmable through a rear panel fifty-pin connector. Frequency can be digitally programmed for 10,000 points across each band with the addition of one of the optional plug-in printed circuit boards.

1-32. ACCESSORIES SUPPLIED

1-33. Figure 1-1 shows the HP Model 8620C Sweep Oscillator mainframe and accessories supplied. The accessories consist of a 0–10V Calibration scale (HP Part No. 08620-00021) a power cable (see Figure 2-2 for HP Part Number) and the accessory kit (HP Part No. 08620-60123). The power cable is described in Section II, Installation.

1-34. The A12 HP-IB Interface Assembly (08620-60118). HP-IB connector/adaptor (08620-60130), and HP-IB interconnect cable (10631B) are supplied for the 8620C Option 011 (See Figure 1-3). The A6 BCD Programming Assembly (08620-60116) is supplied for Option 001. (See Figure 1-2.)

1-35. ACCESSORY KIT

1-36. The accessory kit (shown in Figure 1-1) contains a reversing extender board, two three-amp fuses, an incandescent lamp, and a fifty-pin connector. The reversing extender board permits all the necessary interconnections to be made between the Model 8620C mainframe and the plug-in board assembly being serviced. The two three-amp fuses

are spares for the A4 and A5 Regulator Assemblies. The fifty-pin connector plugs into the rear-panel PROGRAMMING connector. The incandescent lamp is a spare for the mode select pushbuttons.

1-37. EQUIPMENT REQUIRED BUT NOT SUPPLIED

1-38. To have a complete operating unit, the Model 8620C Sweep Oscillator mainframe must have an RF Plug-in installed. The plug-in may either be an HP Model 8621B RF Section with appropriate oscillator module(s) installed or an 86200 series RF Plug-in.

1-39. EQUIPMENT AVAILABLE**1-40. Service Accessories**

1-41. A service accessories package containing a plug-in extender cable, an adjustment tool, and two service boards may be obtained from Hewlett-Packard by ordering Service Accessories Part No. 08620-60124. This is supplied for convenience in aligning and troubleshooting the mainframe, the RF Section and oscillator modules, and an RF Plug-in units. Parts contained in the service accessories package are listed in Figure 1-5.

1-42. Model 8410B/8411A Network Analyzer

1-43. The Model 8620C Sweeper is compatible with the Hewlett-Packard Model 8410B Network Analyzer System. The combination of the Model 8410B Network Analyzer, the Model 8411A Frequency Converter, and an appropriate display plug-in forms a phasemeter and a ratiometer for direct phase and amplitude ratio measurement on RF voltages. These measurements can be made on single frequencies and on swept frequencies from 110 MHz to 18 GHz. Some plug-ins are capable of multi-octave sweeps in this range. Interface cable HP Part Number 8120-2208 must be used when sweeping octave or multi-octave bandwidths or the 8410B will not phase lock properly. (See Figure 1-6 for description of cable.)

1-44. Power Meters and Crystal Detectors

1-45. Depending on the RF section used, the RF output can be externally leveled using power meters or crystal detectors. Refer to the Operating and Service Manual of the RF Plug-in used for detailed information on leveling systems that may be used with the 8620C/RF Plug-in combination.

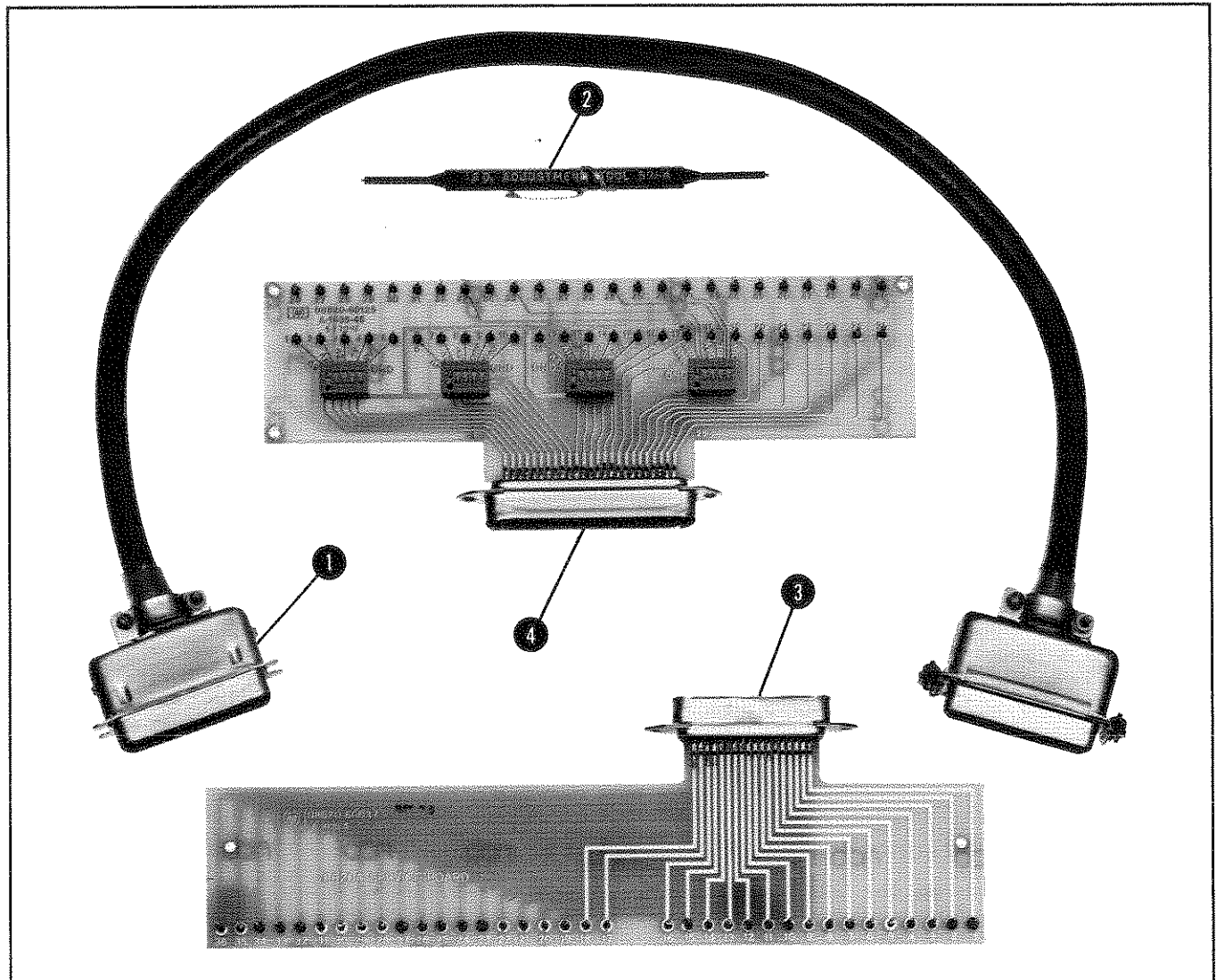

Item	Name	Part No.	Use
1	Extender Cable	08620-60032	Moves RF Plug-in outside mainframe for alignment or service.
2	Adjustment Tool	8830-0024	Fits miniature adjustment slot on potentiometers.
3	36-Pin Service Board	08620-60037	Allows probing RF Section Interface connector, or rear-panel programming connector on all mainframes except 8620C, during performance testing or troubleshooting of 8260 Series mainframes.
4	50-Pin Service Board	08620-60125	Allows probing rear-panel programming connector during performance testing or troubleshooting of HP Model 8620 Sweep Oscillator mainframe.

Figure 1-5. Service Accessories, HP Part Number 08620-60124

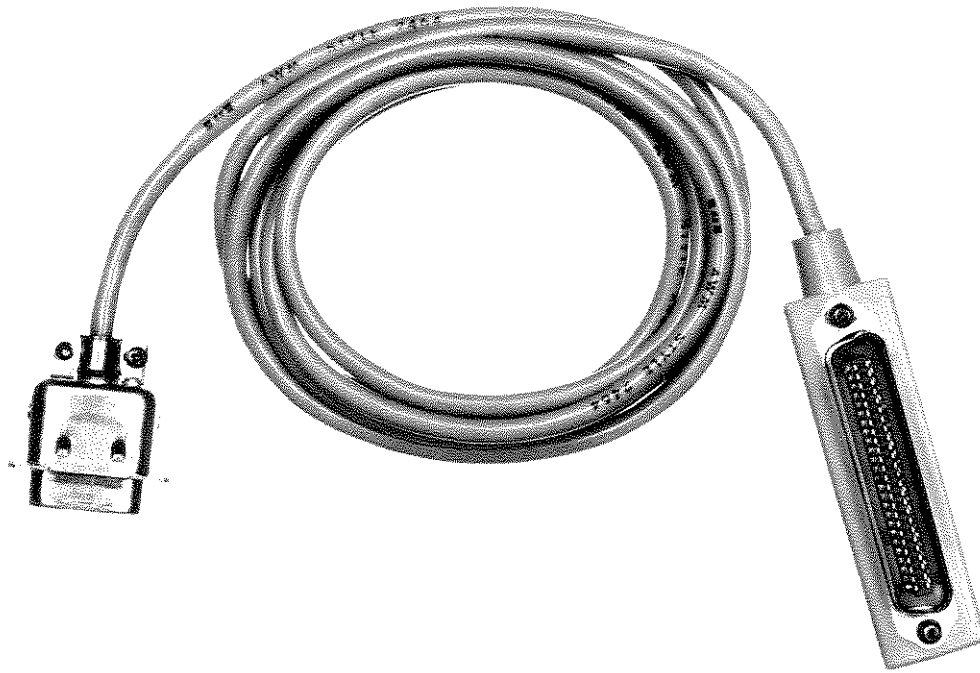

The 8410B has an Auto-frequency range mode which gives it the capability of automatically tracking the HP Model 8620C Sweep Oscillator over octave and multi-octave frequency bands from 110 MHz to 18 GHz.

Interface cable HP Part Number 8120-2208 must be used when sweeping octave or multi-octave bandwidths, or the 8410B will not phase-lock properly. Detailed wiring of this cable is shown in table below.

P/N 8120-2208 (For Use with 8410B and 8620C)			
J17 (8410B)	Color Code	J2 (8620C/50 Pin)	Use
Pin 7	6	Pin 34	Stop Sweep Pulse
Pin 1	4	Pin 26	Sequential Sweep Trigger
Pin 9	2	Pin 50	HP-IB Data Strobe Trigger
Pin 11	0	Pin 43	Ground

Figure 1-6. HP Model 8410B Auto-Frequency Mode Interface Cable

1-46. HP-IB Equipment

HP 10631A Cable-1 metre HP-IB Cable
 HP 10631B Cable-2 metre HP-IB Cable
 HP 10631C Cable-4 metre HP-IB Cable
 HP 59401A Bus System Analyzer

Troubleshoots hardware and software problems on HP-IB

HP 8620C Cable Adapter (8120-2207)
 (See Figure 2-11.)

Connects to 50-pin PROGRAMMING connector and has feed-through pins for troubleshooting and additional interfacing.

1-47. RECOMMENDED TEST EQUIPMENT

1-48. Equipment required to maintain the Model 8620C is listed in Table 1-2. Other equipment may be substituted if it meets or exceeds the critical specifications listed in the table.

1-49. 8620C OPTION 011 DESCRIPTION

1-50. The Model 8620C Option 011 provides a remote programming capability for the 8620C sweeper, with the Hewlett-Packard Interface Bus (HP-IB) as the common link between instruments. It provides remote programming of the sweep modes, band selection, frequency, and a remote marker. The sweep functions may be digitally programmed and the frequency endpoints set by an internal remote control voltage. Sweep functions may also be programmed for local control with frequency endpoints set by front-panel controls and with a digitally controlled marker. All programming is routed through a rear-panel fifty-pin connector from either a computer or calculator.

1-51. HP-IB General Information

1-52. The Hewlett-Packard Interface Bus (HP-IB) is an instrumentation interface for integrating instruments, calculators, and computers into systems. The Bus uses sixteen signal lines to effect transfer of data and commands to interconnect up to 15 instruments. The HP-IB is normally the only communication link between the interconnected units. The instruments on the Bus are connected in parallel as shown in Figure 1-7. Eight of the signal lines (DI01—DI08) are used for the transfer of data and other messages in a byte-serial, bit-parallel

form. The remaining eight lines are used for communication timing (Handshake), control, and status information. A glossary of HP-IB terms is contained in Table 1-3.

1-53. Data is transmitted on the eight HP-IB data lines as a series of eight-bit characters referred to as "bytes". The meaning of each byte is arbitrary, being different for each type of instrument. Normally, a seven-bit ASCII code (American Standard Code for Information Interchange) is used with the eighth bit available for a parity check, if desired. Data is transferred by means of an interlocked "handshake" technique. This sequence permits asynchronous communications over the range of data rates.

1-54. Three-Wire Handshake Description

1-55. Information is transferred on the data lines under control of a technique called the three-wire handshake. The handshake involves the use of three control lines and operates as follows:

- a. The 8620C indicates that it is ready to accept data by letting the Not Ready for Data (NRFD) line go high. Listeners are connected to the NRFD line in a logical AND configuration so the NRFD line does not go high until all active listeners are ready for data.
- b. After NRFD has gone high, the talker places a data byte on the eight data lines by setting the Data Valid (DAV) line low.
- c. After DAV has gone low, the 8620C pulls NRFD low, accepts the data, and lets the Data Accepted (NDAC) line go high. Again, all listeners are logically ANDed and NDAC does not go high until all listeners have accepted the data.
- d. After the NDAC line has gone high, the talker can let DAV go high again and take the data off the lines. When DAV goes high, the listeners set NDAC back to low and the sequence is ready to repeat with Step a.

NOTE

Data is transferred asynchronously as fast as the slowest active device on the bus.

Table 1-2. Recommended Test Equipment

Instrument	Critical Specifications	Recommended Model	Use*
Oscilloscope	Variable persistence, Dual trace, 20 MHz minimum bandwidth, 5 mV/Div sensibility, and 1 μ S/Div horizontal sweep rate. 10:1 probe and 1:1 probe.	HP 181A/1801A/1820C	P, A, T
Digital Multimeter ¹	Accuracy: 0.004% Input Impedance: 10 M Ω minimum	HP 3490A	P, A, T
Frequency Counter ¹	Range: As required by RF Plug-In	HP 5340A	P
Power Meter ¹	Frequency Range: As required by RF Plug-In Power Range: -20 dBm to +20dBm	HP 436A	P
Power Sensor	Frequency Range: As required by RF Plug-In Power: Up to 100 mW	HP 8481A	P
Pulse Generator	Amplitude: 2 volts positive peak Pulse Width: 0.5 μ S Repetition Rate: 1 MHz	HP 8002A	P
Crystal Detector	As required by RF Plug-In	HP 423A or HP 8470A	P
Calculator		HP 9830A	P, A
10-dB Attenuator	Attenuation: 10 dB \pm 0.5 dB	HP 8491B, Option 001	P
HP-IB Interface Cable	Connectors: HP-IB, 24-pin	HP 10631A/B/C	A
Adapter	APC-7 to Type N, Male	HP 1250-0479	P
Wrench	Right Angle, Bristol, No. 6	HP 8710-0055	A
36-pin Service Board**		HP 08620-60037	P, A, T
50-Pin Service Board**		HP 08620-60125	P, A, T
Extender Cable**		HP 08620-60032	T
Adjustment Tool**		HP 8830-0024	A
HP-IB Calculator Interface		HP 59405A (Option 030)	A

* P = Performance Test; A = Adjustments; T = Troubleshooting

** These parts are included in Service Accessories package, 08620-60124 (Figure 1-5).

¹ These instruments must contain HP-IB option when used for HP-IB testing the 8620C, Option 011.

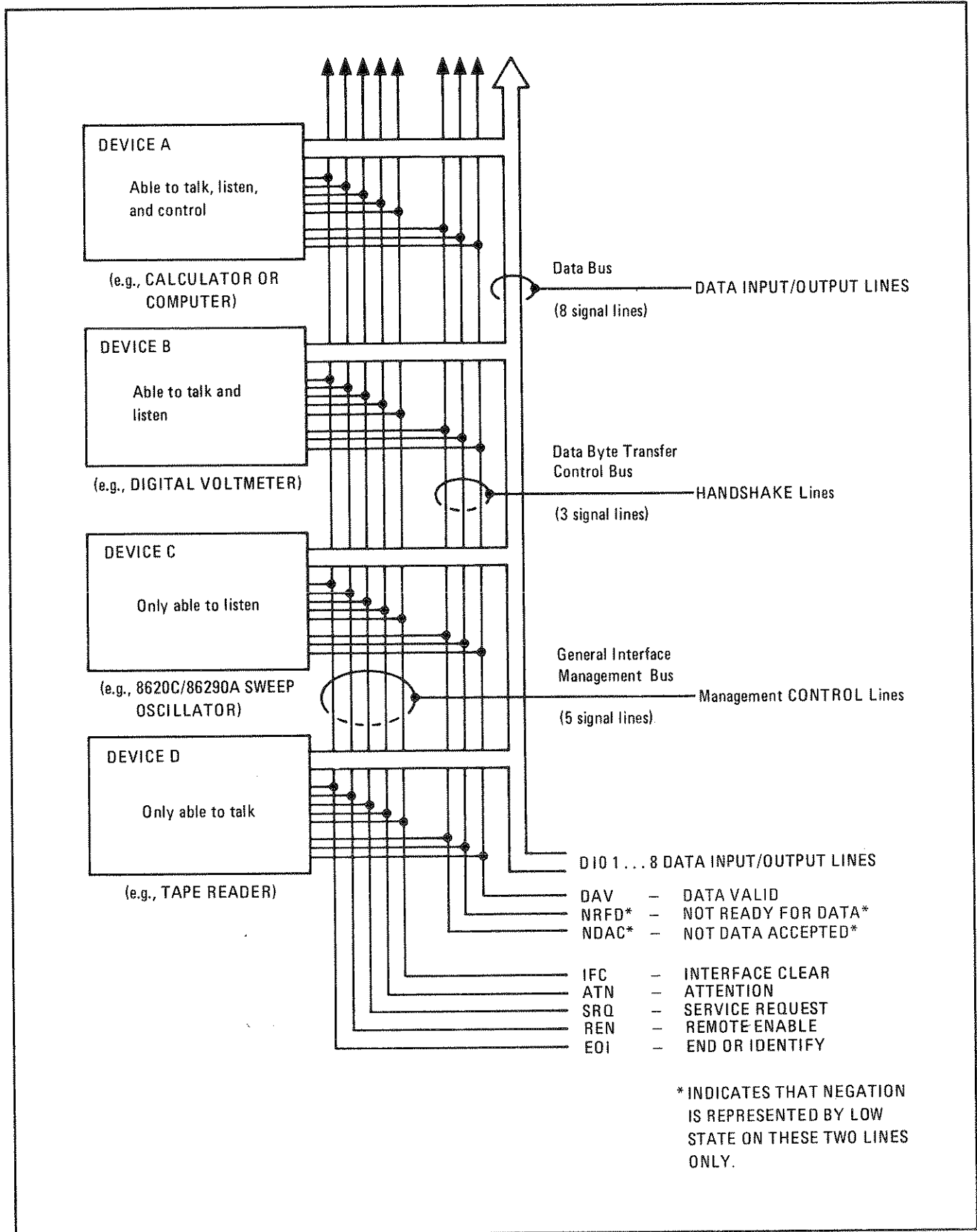

Figure 1-7. Interface Connections and Bus Structure

Table 1-3. Glossary of HP-IB Terms, Relating to 8620C (1 of 2)

ADDRESS – A 7-bit code applied to the HP-IB in Command Mode which enables the 8620C to listen on the Bus.

ADDRESSED COMMANDS – These commands allow the Bus controller to initiate simultaneous actions from addressed instruments which are capable of responding.

ATN – Mnemonic referring to the Attention control line on the HP-IB. This refers to the Command Mode of operation on the HP-IB, or the control line which places the HP-IB in this mode.

BIT – The smallest part of an HP-IB character (Byte) which contains intelligible information.

BUS COMMANDS – A group of Special Codes which initiate certain types of operation in instruments capable of responding to these codes. Each instrument on the HP-IB is designed to respond to those codes that have useful meaning to the device and ignore all others. (See Table 3-4.)

BYTE – An HP-IB character sent over the Data Input/Output (DIO) Lines, normally consisting of eight-bits.

COMMAND MODE – In this mode, devices on the HP-IB can be addressed or unaddressed as talkers or listeners. Bus commands are also issued in this mode.

CONTROLLER – Any device on the HP-IB which is capable of setting the ATN line and addressing instruments on the Bus as talkers and listeners. (Also see System Controller.)

DATA MODE – The HP-IB is in this mode when the ATN control line is high (false). In this mode, data or instructions are transferred between instruments on the HP-IB.

DAV – Mnemonic referring to the Data Valid control line on the HP-IB. This line is used in the HP-IB Handshake sequence.

DIO – Mnemonic referring to the eight Data Input/Output lines of the HP-IB.

EOL – Mnemonic referring to the End or Identify line on the HP-IB.

HANDSHAKE – Refers to the sequence of events on the HP-IB during which each data byte is transferred between addressed devices. The conditions of the HP-IB handshake sequence are as follows:

- a. NRFD, when false, indicates that a device is ready to receive data.
- b. DAV, when true, indicates that data on the DIO lines is stable and available to be accepted by the receiving device.
- c. NDAC, when false indicates to the transmitting device that data has been accepted by the receiver.

HP-IB – An abbreviation that refers to the Hewlett-Packard Interface Bus.

IFC – Mnemonic referring to the Interface Clear control line on the HP-IB. Only the system controller can activate this line. When IFC is set (true) all talkers and listeners on the HP-IB are unaddressed, and controllers go to the inactive state.

LISTENER – A device addressed to receive data or instructions from other instruments on the HP-IB. (Also see Extended Listener.)

NDAC – Mnemonic referring to the Not Data Accepted line on the HP-IB.

Table 1-3. Glossary of HP-IB Terms, Relating to 8620C (2 of 2)

NRF D – Mnemonic referring to the Not Ready For Data control line on the HP-IB. This line is used in the HP-IB Handshake sequence.

REN – Mnemonic referring to the Remote Enable control line on the HP-IB. This line is used to enable Bus compatible instruments to respond to commands from the controller or another talker. It can be issued only by the system controller.

SRQ – Mnemonic referring to the Service Request line on the HP-IB.

SYSTEM CONTROLLER – An instrument on the HP-IB having all the features of a standard controller with the added ability to control the IFC and REN lines. (Also see Controller.)

UNLISTEN COMMAND – This is the Unlisten Command (?). When the Unlisten Command (?) is transmitted on the HP-IB, listeners on the Bus will be unaddressed as listeners.

UNIVERSAL COMMAND – These commands affect every device capable of responding on the HP-IB, regardless of whether they have been addressed or not.

UNADDRESS COMMAND – See UNLISTEN COMMAND.

SECTION II INSTALLATION

2-1. INTRODUCTION

2-2. This section provides installation instructions for the Model 8620C Sweep Oscillator and its accessories. This section also includes information about initial inspection and damage claims, preparation for using the Sweep Oscillator, and packaging, storage and shipment.

2-3. INITIAL INSPECTION

2-4. Inspect the shipping container for damage. If the shipping container or cushioning material is damaged it should be kept until the contents of the shipment have been checked for completeness and the instrument has been checked mechanically and electrically. Procedures for checking electrical performance are given in Section IV. If the instrument combination does not pass the electrical performance tests, refer to the Adjustments (Section V) in this manual. If, after the Adjustments have been made, the instrument combination still fails to meet specifications, refer to RF Plug-in Adjustments in the applicable RF Plug-in manual. If a circuit malfunction is suspected, refer to troubleshooting procedures section of this manual or applicable RF Plug-in manual. If the instrument does not pass the above electrical tests, or if the shipment contents are incomplete, or if there is mechanical damage or defect, notify the nearest Hewlett-Packard office. If the shipping container is damaged, or the cushioning material shows signs of stress, notify the carrier as well as the Hewlett-Packard office. Keep the shipping materials for carrier's inspection. The HP office will arrange for repair or replacement without waiting for claim settlement.

2-5. PREPARATION FOR USE

2-6. Power Requirements

2-7. The Model 8620C requires a power source of 100, 120, 220, or 240 Vac, +5% -10%, 50 to 400 Hz single phase. Power consumption is approximately 140 watts with RF Section and oscillator module(s) installed.

2-8. Line Voltage Selection

CAUTION

BEFORE SWITCHING ON THIS INSTRUMENT, make sure the instrument is set to the voltage of the power source.

2-9. Figure 2-1 provides instructions for line voltage and fuse selection. The line voltage selection card and the proper fuse are factory installed for 120 Vac operation.

2-10. Power Cable

2-11. In accordance with international safety standards this instrument is equipped with a three wire power cable. When connected to an appropriate power line outlet, this cable grounds the instrument cabinet. Figure 2-2 shows the styles of mains plugs available on power cables supplied with HP instruments. The numbers under the plugs are part numbers for complete power cables. The types of power cable/plug shipped depends on the country of destination.

WARNING

BEFORE SWITCHING ON THIS INSTRUMENT, be sure only the specified power cord is used. The instrument is provided with a 3-wire power cord which grounds the instrument cabinet. This power cord should only be inserted in a socket outlet provided with a protective earth contact. This protective action should not be negated by the use of an extension cord (power cable) without a protective conductor (ground). Grounding one conductor of a two conductor outlet is not sufficient protection.

2-12. Interconnections

2-13. For the Model 8620C Sweep Oscillator to operate, an RF Plug-in or an RF Section with an oscillator module installed, must be plugged into the 8620C mainframe. Refer to RF Plug-in manual for RF Plug-in installation instructions.

RECEPTACLE FOR PRIMARY POWER CORD

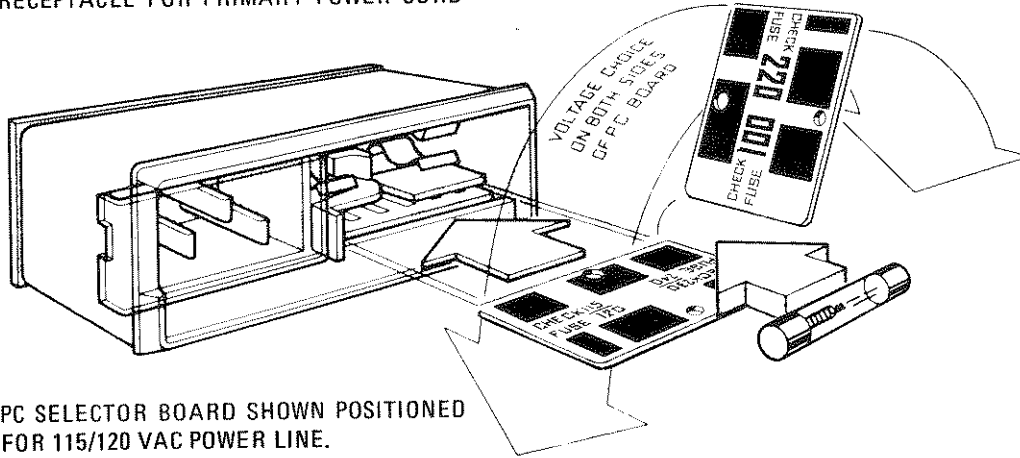

OPERATING VOLTAGE APPEARS IN MODULE WINDOW.

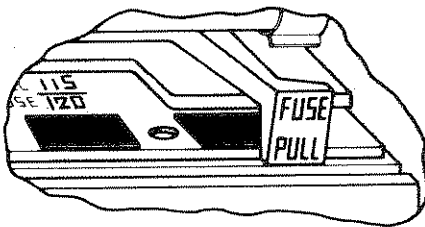

SELECTION OF OPERATING VOLTAGE

1. SLIDE OPEN POWER MODULE COVER DOOR AND PUSH FUSE-PULL LEVER TO LEFT TO REMOVE FUSE.
2. PULL OUT VOLTAGE-SELECTOR PC BOARD. POSITION PC BOARD SO THAT VOLTAGE NEAREST ACTUAL LINE VOLTAGE LEVEL WILL APPEAR IN MODULE WINDOW. PUSH BOARD BACK INTO ITS SLOT.
3. PUSH FUSE-PULL LEVER INTO ITS NORMAL RIGHT-HAND POSITION.
4. CHECK FUSE TO MAKE SURE IT IS OF CORRECT RATING AND TYPE FOR INPUT AC LINE VOLTAGE. FUSE RATINGS FOR DIFFERENT LINE VOLTAGES ARE INDICATED BELOW POWER MODULE.
5. INSERT CORRECT FUSE IN FUSEHOLDER.

Figure 2-1. Line Voltage Selection with Power Module PC Board





Plug Type	Cable HP Part Number	Plug Description	Cable Length (inches)	Cable Color	For Use In Country
250V 	8120-1351 8120-1703	Straight*BS1363A 90°	90 90	Mint Gray Mint Gray	Great Britain , Cyprus, Nigeria , Rhodesia , Singapore , So. Africa, India
250V 	8120-1369 8120-0696	Straight*NZSS198/ASC112 90°	79 87	Gray Gray	Australia , New Zealand
250V 	8120-1689 8120-1692	Straight*CEE7-Y11 90°	79 79	Mint Gray Mint Gray	East and West Europe, Saudi Arabia, United Arab Republic (unpolarized in many nations)
125V 	8120-1348	Straight*NEMA5-15P	80	Black Black Black	United States , Canada , Japan (100 or 200V) , Mexico , Phillippines , Taiwan
	8120-1398 8120-1754	Straight*NEMA5-15P	80 36		
	8120-1378 8120-1521	Straight*NEMA5-15P 90°	80 80	Jade Gray Jade Gray	
	8120-1676	Straight*NEMA5-15P	36	Jade Gray	
250V 	8120-2104	Straight*SEV1011 1959-24507 Type 12	79	Gray	Switzerland
250V 	8120-0698	Straight*NEMA6-15P			
250V 	8120-1860	Straight*CEE22-VI			
* Part number shown for plug is industry identifier for plug only. Number shown for cable is HP Part Number for complete cable including plug. E = Earth Ground; L = Line; N = Neutral					

Figure 2-2. AC Power Cables Available

2-14. Mating Connectors

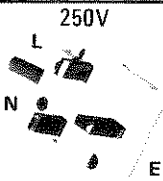
2-15. All of the externally mounted connectors on the mainframe are listed in Table 2-1. Opposite each mainframe connector is an industry identification, the part number of a mating connector, and the part number of an alternate source for the mating connector.

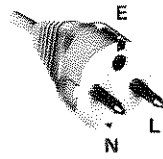
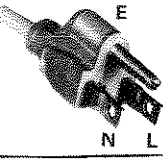
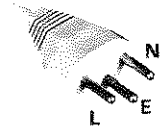
2-16. Operating Environment

2-17. Temperature. The instrument may be operated in temperatures from 0°C to +55°C.

2-18. Humidity. The instrument may be operated in environments with humidity from 5% to 95% at 0° to 40°C. However, the instrument should also be protected from temperature extremes which cause condensation within the instrument.

2-19. Altitude. The instrument may be operated at altitudes up to 4572 metres (15 000 feet).

2-20. Cooling

2-21. Clearances for ventilation should be three to four inches at the rear of the cabinet and two to three inches at the sides. The clearances provided by the plastic feed in bench stacking and the

filler strips in rack mounting are adequate for the top and bottom cabinet surfaces.

2-22. Bench Operation

2-23. The instrument cabinet has plastic feet and a foldaway tilt stand for convenience in bench operation. The tilt stand inclines the instrument for ease of operating. The plastic feet provide clearance for air circulation and make the instrument self-aligning when stacked on other Hewlett-Packard full rack-width modular instruments.

2-24. Rack Mounting (Option 908)

2-25. Instruments with Option 908 contain a Rack Flange Kit. This kit supplies necessary hardware and installation instructions for preparing the instrument to be mounted on a rack of 482.6 mm (19 inch) spacing. Installation instructions are also given in Figure 2-3. A Rack Mounting Kit for the 8620C may be obtained from Hewlett-Packard by ordering HP Part Number 5060-8740.

2-26. Frequency Scale Installation

2-27. To install frequency scale, proceed as follows:

Table 2-1. Model 8620C Mating Connectors

8620C Connector		Mating Connector	
Connector Name	Industry Identification	HP Part No.	Alternate Source
J1 SWEEP OUT	BNC	1250-0256	Specialty Connector 25-P118-1
J2 PROGRAMMING	Micro-Ribbon 50-Contact Rack and Panel Plug	1251-0086	TRW Cinch Div. 57-30500-375
J3 EXT AM	BNC	1250-0256	Specialty Connector 25-P118-1
J4 EXT TRIGGER	BNC	1250-0256	Specialty Connector 25-P118-1
J5 NEGATIVE BLANKING	BNC	1250-0256	Specialty Connector 25-P118-1
J6 RF Plug-in Interface	Micro-Ribbon 36-Contact Rack and Panel Plug	1251-3066	Amphenol 222-42-36-058
J8 Z-AXIS/MKR/ PEN LIFT	BNC	1251-0256	Specialty Connector 25-P118-1

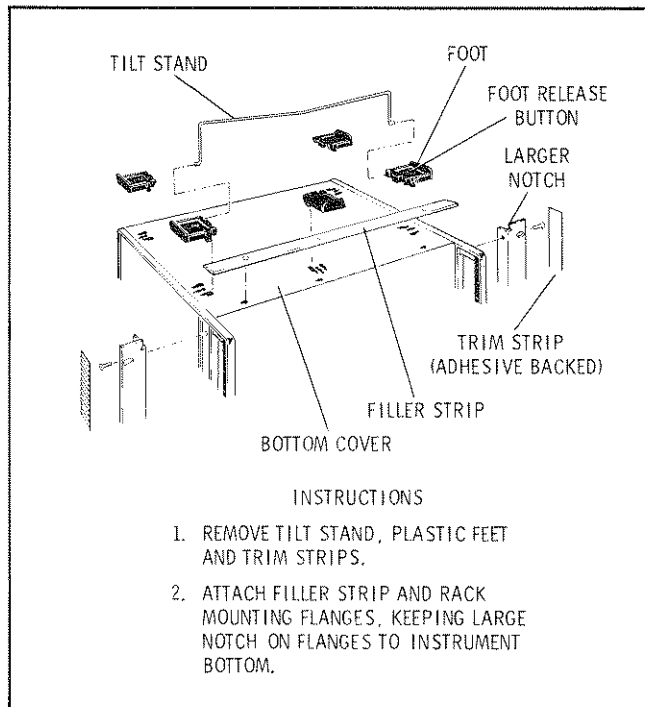

Figure 2-3. Preparation for Rack Mounting

NOTE

If RF Plug-in is installed in mainframe, it must be removed to install frequency scale. See RF Plug-in removal instructions in Operating and Service Manual for RF Plug-in.

- a. Disengage mainframe front-panel latch handle, shown in Figure 2-4, by pushing downward on handle while pushing inward lightly on top of front panel.
- b. Swing front panel forward and down to position shown in Figure 2-5.
- c. Depress mainframe front-panel BAND select lever, shown in Figure 2-4, to rotate frequency scale drum until desired scale position is accessible.

NOTE

Drum positions 1 through 4 may be identified by tick marks (I, II, III, IIII) on left-hand side of drum.

NOTE

If necessary to remove a frequency scale, exert a pressure OUTWARD, away from drum, on right-hand edge of scale.

- d. Insert frequency scale so key (a 1/16-inch long, 1/2-inch wide protrusion) on left end of scale fits into notch, shown in Figure 2-5 in roller on left-hand edge of drum.
- e. Push inward on right-hand edge of frequency scale to snap it in place in frequency scale drum.

CAUTION

To prevent damage to frequency pointers when bandswitch drum is rotated, make certain that frequency scale is firmly in place and flush with band drum edges.

- f. Return front panel to upright (closed) position, and, while pushing inward lightly on top of front panel, re-engage front-panel latch handle by pushing it upward to lock position as shown in Figure 2-4, exploded view.

2-28. MODEL 8620C HP-IB INTERFACE (OPTION 011) INSTALLATION

2-29. Interface Connectors and Cables

2-30. The HP-IB connector/adaptor (HP Part No. 08620-60130) is a 50-pin-to-24-pin adapter that is connected to the rear-panel, 50-pin PROGRAMMING connector. The 24-pin connector interfaces directly to the HP-IB interconnect cable. The two-meter HP-10631B interface cable (Figure 2-6) interfaces the 8620C Sweep Oscillator with the HP-IB. The connectors on the cable consist of two standard HP-IB 24-pin connectors. (See Figure 2-7 for the pin configuration of the HP-IB connector.)

2-31. Cable Length Restrictions

2-32. As many as 15 instruments can be connected in parallel on the Hewlett-Packard Interface bus. To achieve design performance on the bus, proper voltage levels and timing relationships must be maintained. If the system cable is too long or if the accumulated cable length between instruments is too long, the data and control lines cannot be driven properly and the system may fail to perform. Therefore, the following restrictions must be observed:

- a. With two instruments in a system, the cable length must not exceed four meters (12 feet).

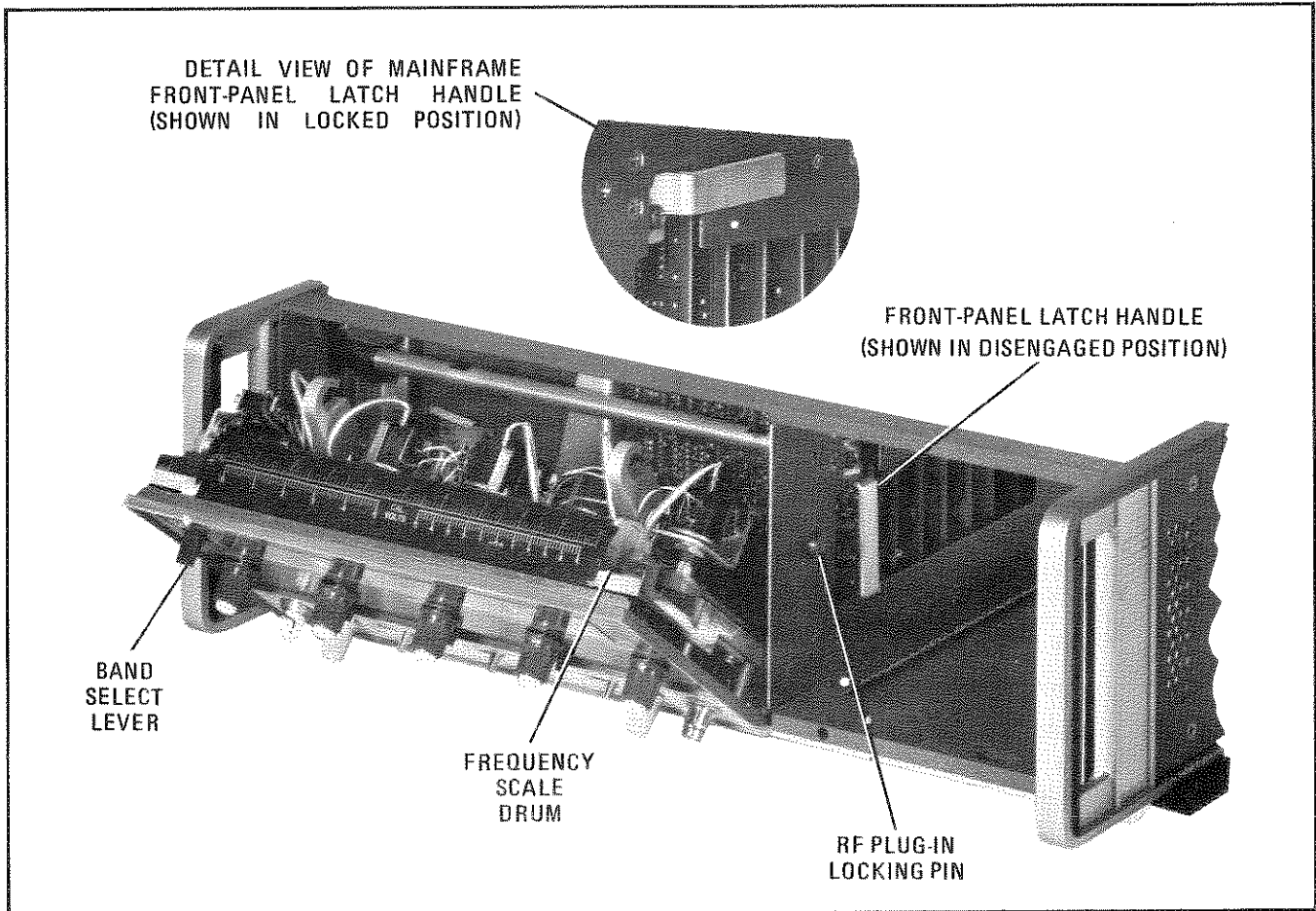

Figure 2-4. Location of Mainframe Parts Pertinent to Frequency Scale and RF Plug-in Installation

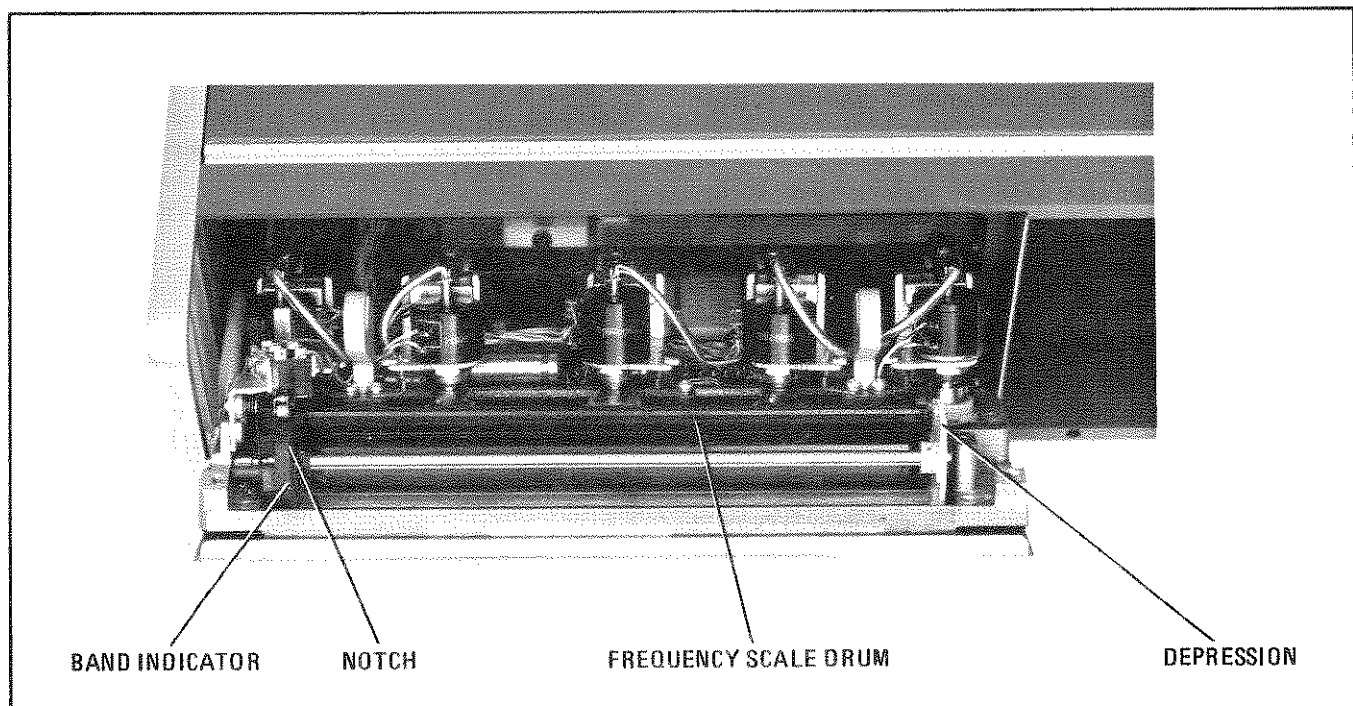

Figure 2-5. Mainframe Front Panel in Open Position

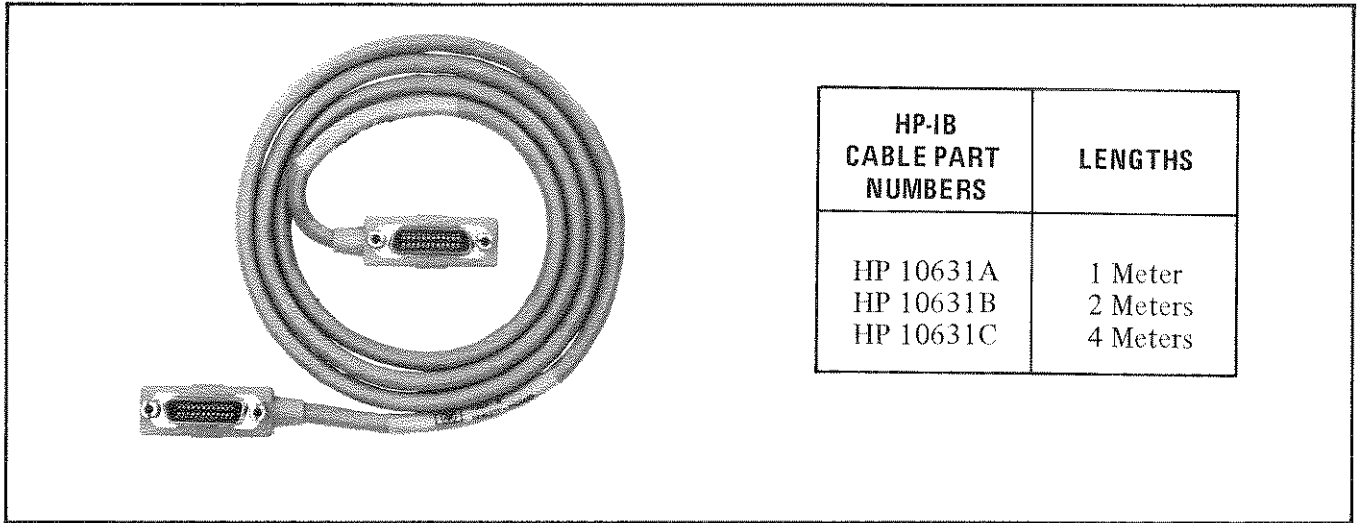

Figure 2-6. HP-IB Interface Cable

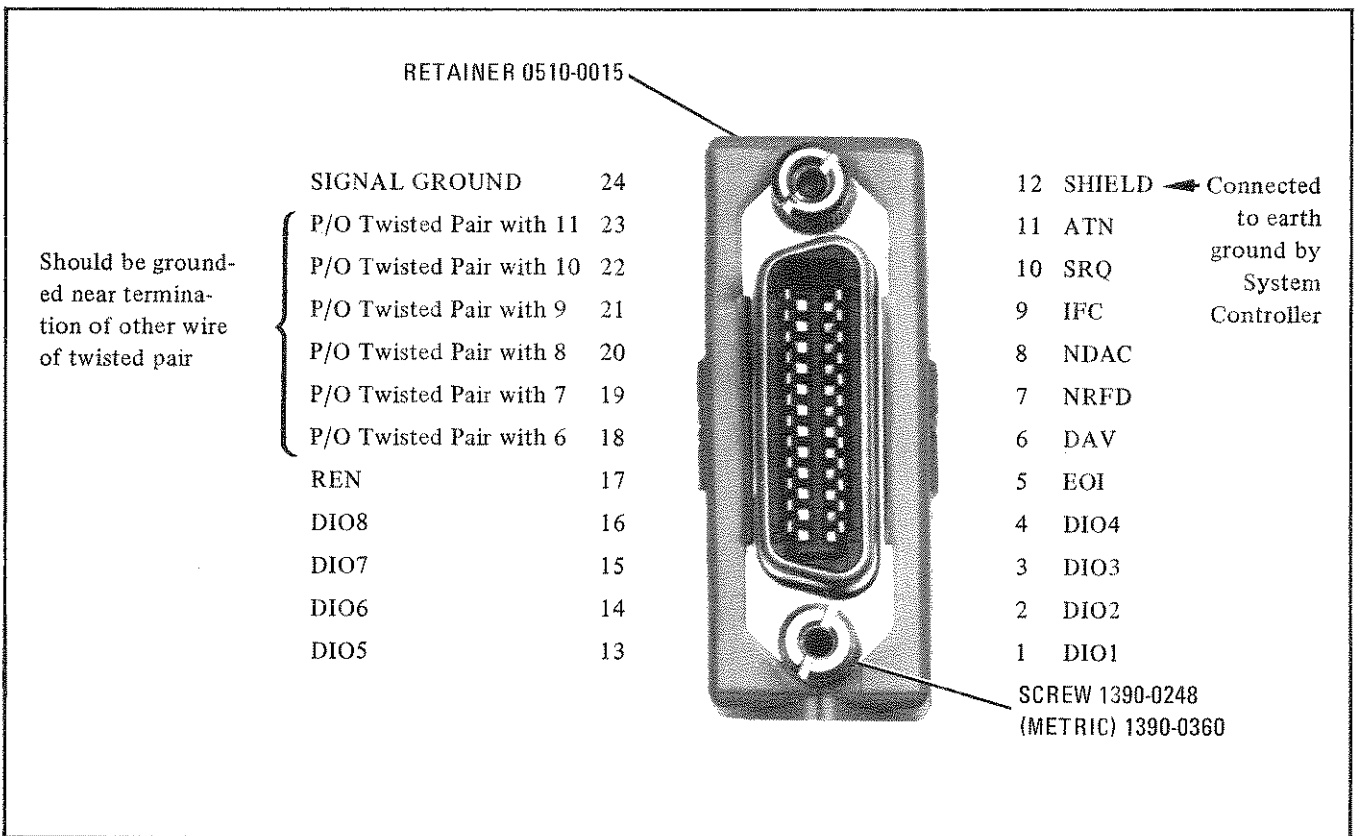

Figure 2-7. HP-IB Connector/Adaptor 08620-60130, Pin Configuration

- b. When more than two instruments are connected on the bus, the cable length to each instrument cannot exceed two meters (six feet) per unit.
- c. The total cable length between all units cannot exceed 20 meters (65 feet).

2-33. HP-IB Interface Assembly

2-34. The circuit board for the 8620C Option 011 is the A12 HP-IB Interface Assembly (Option 011), HP Part No. 08620-60118. (See Figures 1-3 and 8-26.) The HP-IB interface is available when this board is installed in the XA6 connector of the A11 Master Board.

2-35. Address Switch

2-36. The 8620C address switch A12SW1 is pre-set at the factory to ASCII character "&". Upon installation of the A12 HP-IB Interface Assembly, any of the 30 listen-address codes shown in Table 3-5 may be used. The code selected must of course be compatible with the system. The switches in Figure 2-8 are set in the ASCII character "&" address code (Octal 046). The numbers 1 through 5 etched on the A12 board correspond to b_1 through b_5 in Table 3-5. Number 1 is the Least Significant Bit (LSB) and number 5 is the Most Significant Bit (MSB).

2-37. HP-IB/Model 8410B Network Analyzer Installation

2-38. The following installation provides simultaneous operation between the 8410B Network analyzer, and the 8620C Sweeper with the HP-IB. The 8410B Cable (HP Part No. 8120-2208) has a standard 14-pin 8410B connector on one end and a 50-pin, piggy-back connector on the other end, which connects to the 8620C rear-panel PROGRAMMING connector J2. The HP-IB connector/

adapter is connected and then the HP-IB cable. The installation procedure follows and the completed installation is shown in Figure 2-9.

- a. Remove HP-IB Connector/Adapter 08620-60130 if it is connected to PROGRAMMING connector.
- b. Install 8410B cable 8120-2208 (see Figure 1-6).
- c. Install HP-IB Connector/Adapter 08620-60130.
- d. Install HP-IB cable 10631B.

2-39. Installation for Additional Interface Capabilities

2-40. By using a combination of the 8620C cable adapter (8120-2207) and the programming connector (2151-0086) a configuration is available that provides additional remote programming and interface capabilities while retaining HP-IB operation. (Refer to Table 3-8 for a list of the available

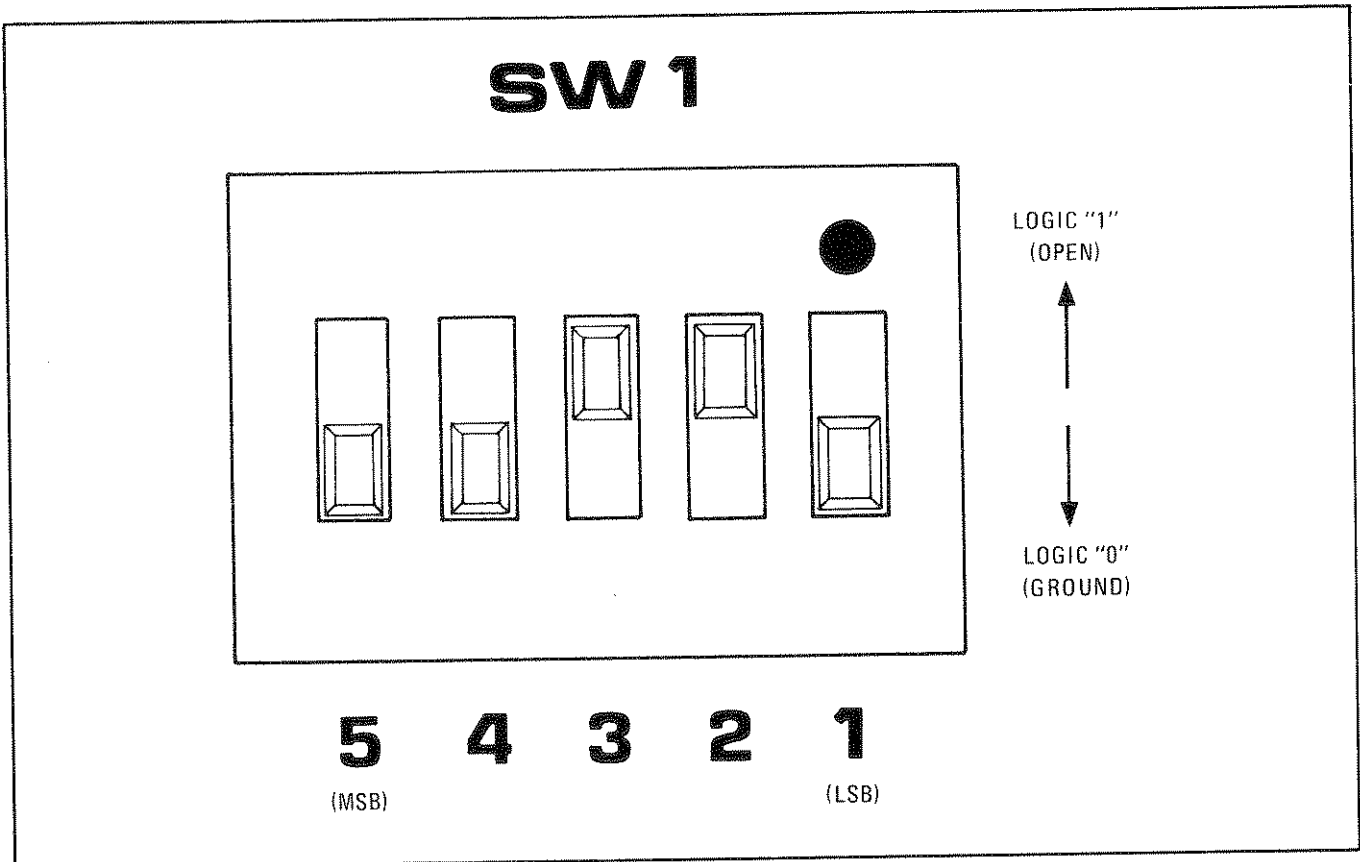

Figure 2-8. Address Switch A12SW1

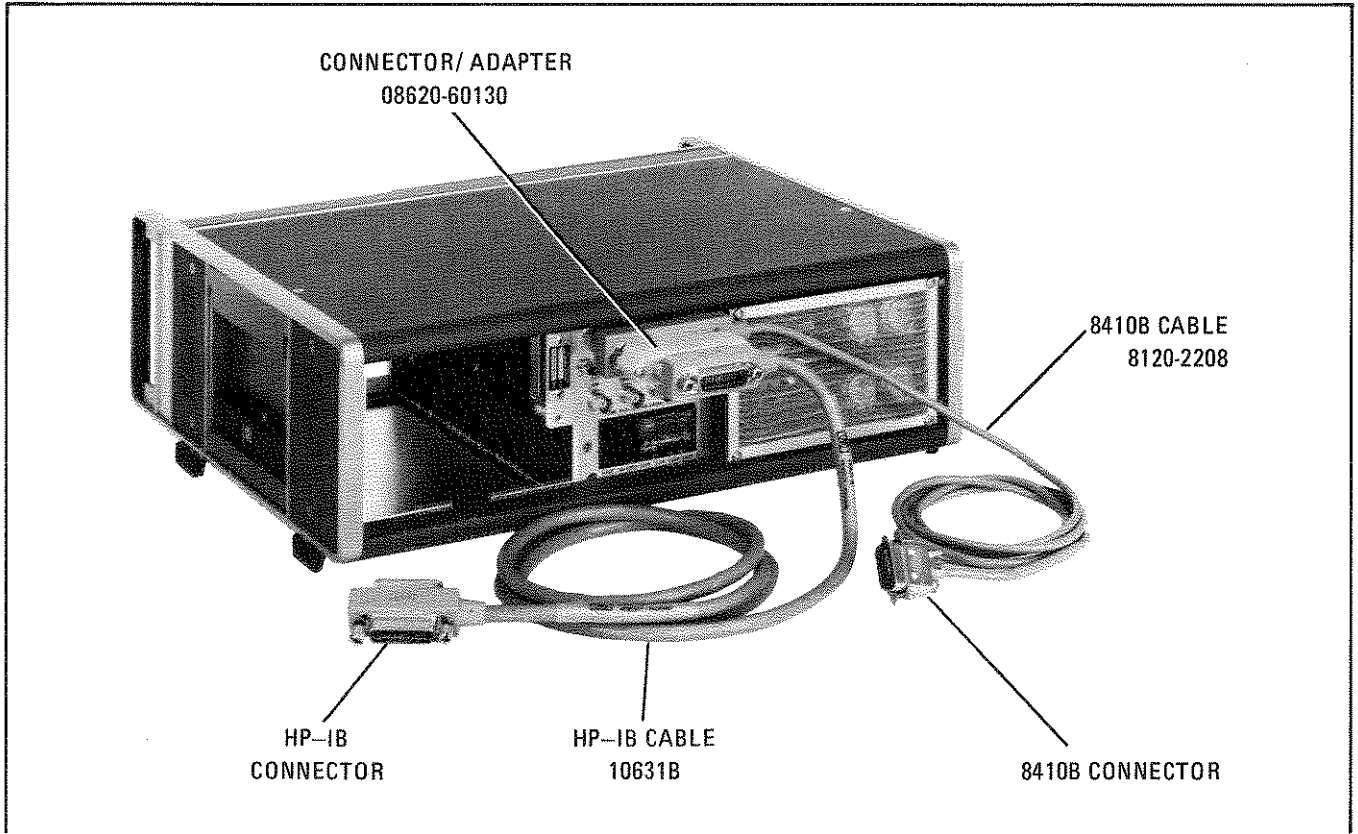

Figure 2-9. HP-IB/8410B Installation

commands, signals, and controls.) The 8620C cable adapter (HP Part No. 8120-2207) has a 50-pin, piggy-back connector on one end, which is connected to the 8620C rear-panel PROGRAMMING connector J2; on the other end is a standard 24-pin HP-IB connector. (See Figure 2-11.) The additional control lines are soldered to pins on the programming connector (HP Part No. 1251-0086, part of Accessory Kit 08620-60123). For example, if remote RF attenuation is desired, connections would be made to pins 36, 37, and 38. The installation procedure follows and the completed configuration is shown in Figure 2-10.

- a. Remove HP-IB Connector/Adapter 08620-60130 if it is connected to PROGRAMMING connector.
- b. Install 8620C cable adapter 8120-2207.
- c. Connect programming connector 1251-0086 with new lines soldered to desired pins.

2-41. VERIFICATION

2-42. To ensure correct electrical performance and remote programming operation after installa-

tion, complete the verification procedure in either Figure 2-12 or Figure 2-13, whichever applies.

2-43. STORAGE AND SHIPMENT

2-44. Environment

2-45. The instrument may be stored or shipped in environments within the following limits:

Temperature	-40°C to +75°C
Humidity	5% to 95% at 0° to 40°C
Altitude	Up to 15240 metres (50000 feet)

The instrument should also be protected from temperature extremes which cause condensation within the instrument.

2-46. Packaging

2-47. Original Packaging. Containers and materials identical to those used in factory packaging are available through Hewlett-Packard offices. If the instrument is being returned to Hewlett-Packard for servicing, attach a tag indicating the type of

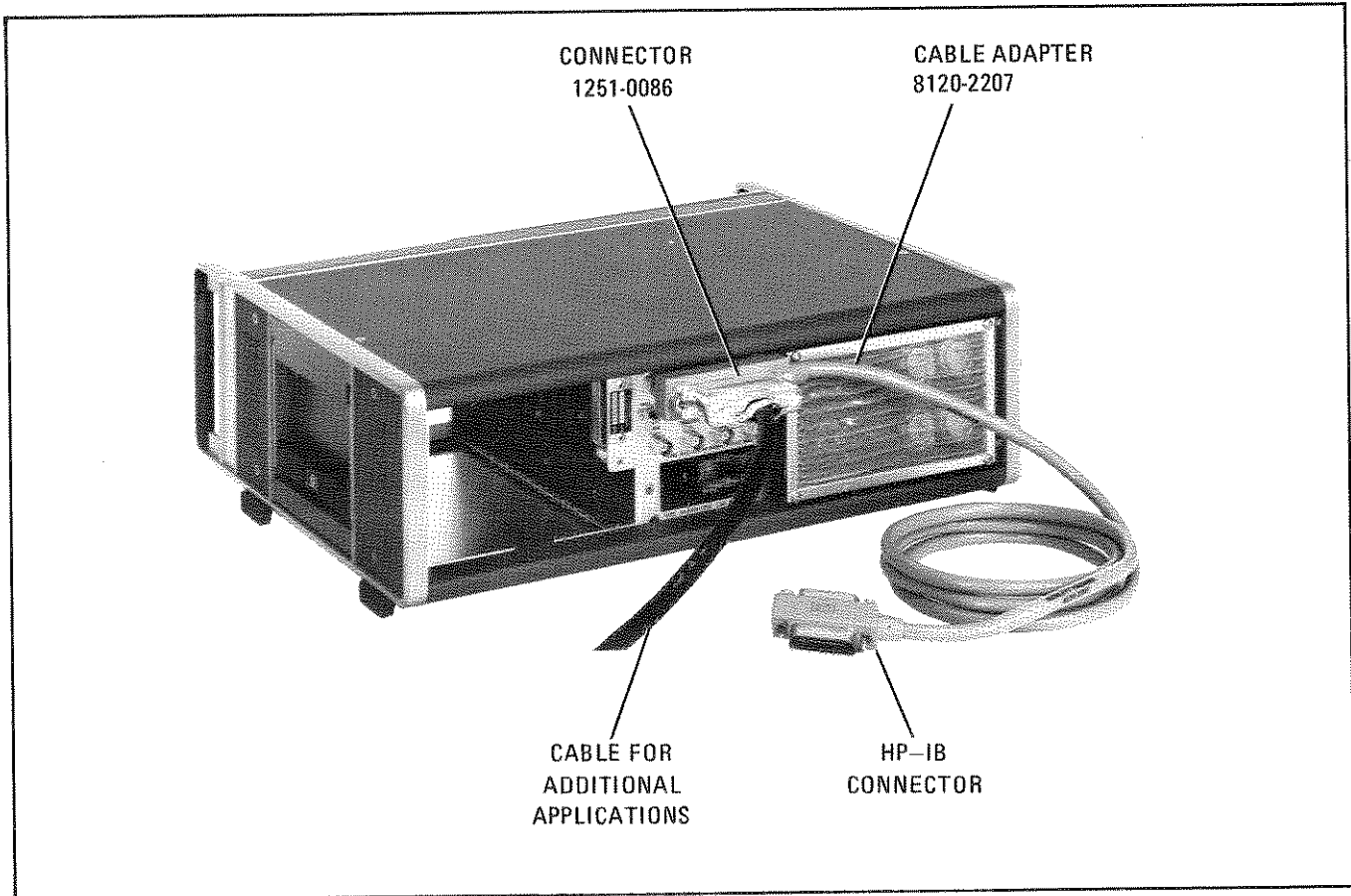
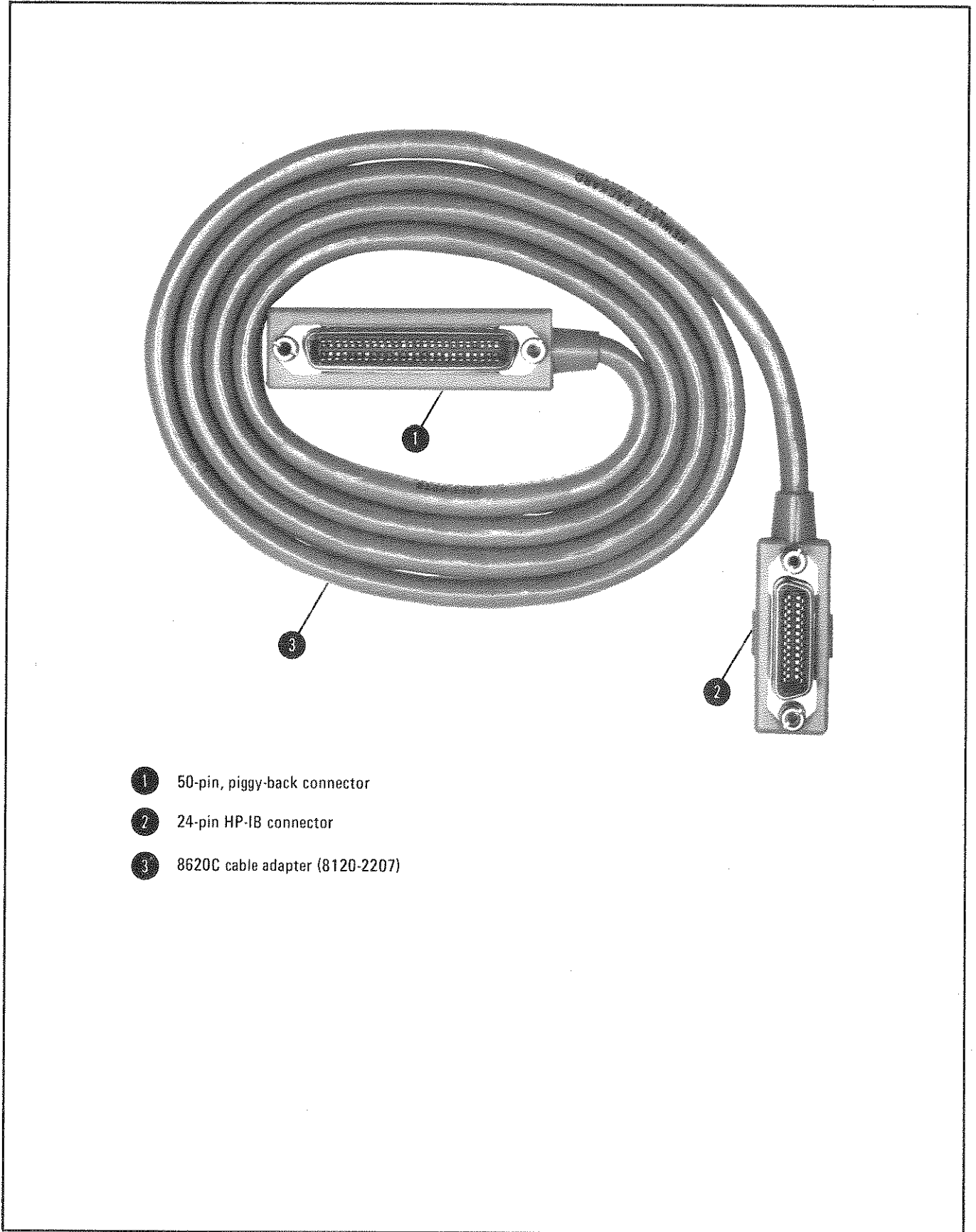

Figure 2-10. Installation for Additional Interface Capabilities

service required, return address, model number, and full serial number. Also, mark the container **FRAGILE** to assure careful handling. In any correspondence, refer to the instrument by model number and full serial number.

2-48. Other Packaging. The following general instructions should be used for re-packaging with commercially available materials:

- a. Wrap instrument in heavy paper or plastic. (If shipping to Hewlett-Packard Office or Service Center, attach tag indicating type of service required, return address, model number and full serial number.)
- b. Use a strong shipping container.
- c. Use enough shock-absorbing material around all sides of instrument to provide firm cushion and prevent movement inside container. Protect control panel with cardboard.
- d. Seal shipping container securely.
- e. Mark shipping container **FRAGILE** to assure careful handling.
- f. In any correspondence, refer to instrument by model number and full serial number.



- ① 50-pin, piggy-back connector
- ② 24-pin HP-IB connector
- ③ 8620C cable adapter (8120-2207)

Figure 2-11. 8620C Cable Adapter for Additional Interface Capabilities

```

90 REM CHECK MODE OPERATION *****
95 DISP "MODES"
100 CMD "?U&"
110 FOR J=1 TO 5
120 FOR I=1 TO 4
130 OUTPUT (13,140)I
140 FORMAT "M",F1000.0
150 WAIT 200
160 NEXT I
170 NEXT J
180 CMD "","M1"
190 REM CHECK BAND OPERATION *****
195 DISP "BANDS"
200 FOR J=1 TO 5
210 FOR I=1 TO 4
220 OUTPUT (13,230)I
230 FORMAT "B",F1000.0
240 WAIT 200
250 NEXT I
260 NEXT J
270 CMD "","B1"
280 REM CHECK VOLTAGES *****
290 CMD "","M1"
300 CMD "","V0E"
310 DISP "0.000 V"
320 STOP
330 CMD "","V:000E"
340 DISP "10.000 V"
350 STOP
360 CMD "","V7777E"
370 DISP "7.777 V"
380 STOP
390 CMD "","V8888E"
400 DISP "8.888 V"
410 STOP

490 REM TEST ALL SWEEP MODES *****
500 CMD "?U&","M1B1"
510 DISP "REMOTE FULL SWEEP"
520 GOSUB 1500
530 CMD "?U&","M2"
540 DISP "REMOTE DELTA F SWEEP"
550 GOSUB 1500
560 DISP "REMOTE MARKER SWEEP"
570 CMD "?U&","M4"
580 GOSUB 1500
590 DISP "ANALOG FULL SWP -REMOTE MARKER"
600 CMD "?U&","M5R"
610 GOSUB 1500
620 DISP "ANALOG FULL SWP - LOCAL MARKER"
630 CMD "","L"
640 GOSUB 1500
650 DISP "ANALOG DELTA F SWP - REMOTE MKR"
660 CMD "?U&","M6R"
670 GOSUB 1500
680 DISP "ANALOG MKR SWP - REMOTE MKR"
690 CMD "?U&","M8R"
700 GOSUB 1500
999 BEEP
1000 DISP "DONE"
1490 STOP
1500 REM REMOTE TUNE D/A VOLTAGE
1505 FOR I=1 TO 3
1510 FOR V=0 TO 10 STEP 0.3
1511 WAIT 40
1520 OUTPUT (13,1530)V
1530 FORMAT "V",F1000.3,"E"
1540 NEXT V
1550 NEXT I
1590 RETURN
9999 END

```

Figure 2-12. HP-IB Verification Program (HP 9830A Calculator)

```

0: "CHECK MODE OPERATION *****":
1: prt "MODES";cmd 7,"?U%"
2: for J=1 to 5
3: for I=1 to 4
4: fnt 1,"M",f.0;prt 706.1,I;wait 200
5: next I
6: next J
7: "CHECK BAND OPERATION *****":
8: cmd 7,"?U%","M1";prt "BANDS"
9: for J=1 to 5
10: for I=1 to 4
11: fnt 2,"B",f.0;prt 706.2,I;wait 200
12: next I
13: next J
14: "CHECK VOLTAGES *****":
15: cmd 7,"?U%","M1V0E";prt "0.000 V";stp
16: cmd 7,"?U%","M1V00E";prt "10.000 V";stp
17: cmd 7,"?U%","M1V777E";prt "7.777 V";stp
18: cmd 7,"?U%","M1V888E";prt "8.888 V";stp
19: "TEST ALL SWEEP MODES *****":
20: cmd 7,"?U%","M1B1";prt "REMOTE FULL SWP";esb "volt"
21: cmd 7,"?U%","M2";prt "REMOTE DELTA F SWP";esb "volt"
22: cmd 7,"?U%","M4";prt "REMOTE MKR SWP";esb "volt"
23: cmd 7,"?U%","M5R";prt "ANALOG FULL SWP-REMOTE MKR";esb "volt"
24: cmd 7,"?U%","L";prt "ANALOG FULL SWP-LOCAL MKR";esb "volt"
25: cmd 7,"?U%","M6R";prt "ANALOG DELTA F SWP-REMOTE MKR";esb "volt"
26: cmd 7,"?U%","M8R";prt "ANALOG MARKER SWP-REMOTE MKR";esb "volt"
27: beep;prt "DONE";stp
28: "volt":
29: "REMOTE TUNE D/A VOLTAGE":
30: for I=1 to 3
31: for V=0 to 10 by .3
32: wait 40
33: fnt 3,"V",f.3,"E";prt 706.3,V
34: next V
35: next I
36: ret
37: end
*20176

```

Figure 2-13. HP-IB Verification Program (HP 9825A Calculator)

SECTION III OPERATION

3-1. INTRODUCTION

3-2. This section explains the function of the controls and indicators of the Model 8620C Sweep Oscillator. It describes typical operating models in a measurement system and covers the typical operator maintenance such as fuse, indicator lamp, and fan filter replacement.

3-3. PANEL FEATURES

3-4. Front and rear panel features are described in Figures 3-1 and 3-2. Description numbers match the numbers on the illustration.

3-5. OPERATOR'S CHECK

3-6. The operator's check (Figure 3-4) allows the operator to make a quick check of the main instrument functions prior to use. This check assumes that an RF Plug-in or an RF Section with oscillator module is installed in the mainframe. Incorrect indications may indicate troubles in either the mainframe or RF Plug-in. To determine if the mainframe is working correctly, check the 8620C using the performance tests in Section IV.

3-7. OPERATING INSTRUCTIONS

3-8. Figures 3-5 through 3-8 show general operating procedures with the 8620C connected in a typical measurement test setup. There are many other applications for the 8620C but the general operating procedure is the same.

3-9. Safety

3-10. BEFORE APPLYING POWER, refer to SAFETY CONSIDERATIONS in Section I of this Operating and Service manual.

3-11. The information, cautions, and warnings in this manual must be followed to ensure safe operation and to keep the instrument safe.

WARNING

BEFORE SWITCHING ON THE INSTRUMENT, be sure only the specified power cord is used. The instrument is provided with a 3-wire power cord which grounds the instrument cabinet. This power cord should only be inserted in a socket outlet provided with a protective earth contact. This protection should not be negated by using an extension cord (power cable) without a protective grounding conductor. Grounding one conductor of a two-conductor outlet is not sufficient protection.

WARNING

Any interruption of the protective (grounding) conductor, inside or outside the instrument, or disconnection of the protective earth terminal could make this instrument dangerous. Whenever it is suspected that this protection has been impaired, the instrument should be made inoperative and secured against any unintended operation.

WARNING

BEFORE SWITCHING THE INSTRUMENT ON, ensure that all ac line powered devices connected to the instrument are connected to the protective earth ground.

CAUTION

BEFORE APPLYING POWER, make sure the ac input is set for the available ac line voltage, that the correct fuse is installed, and that all normal safety precautions have been taken.

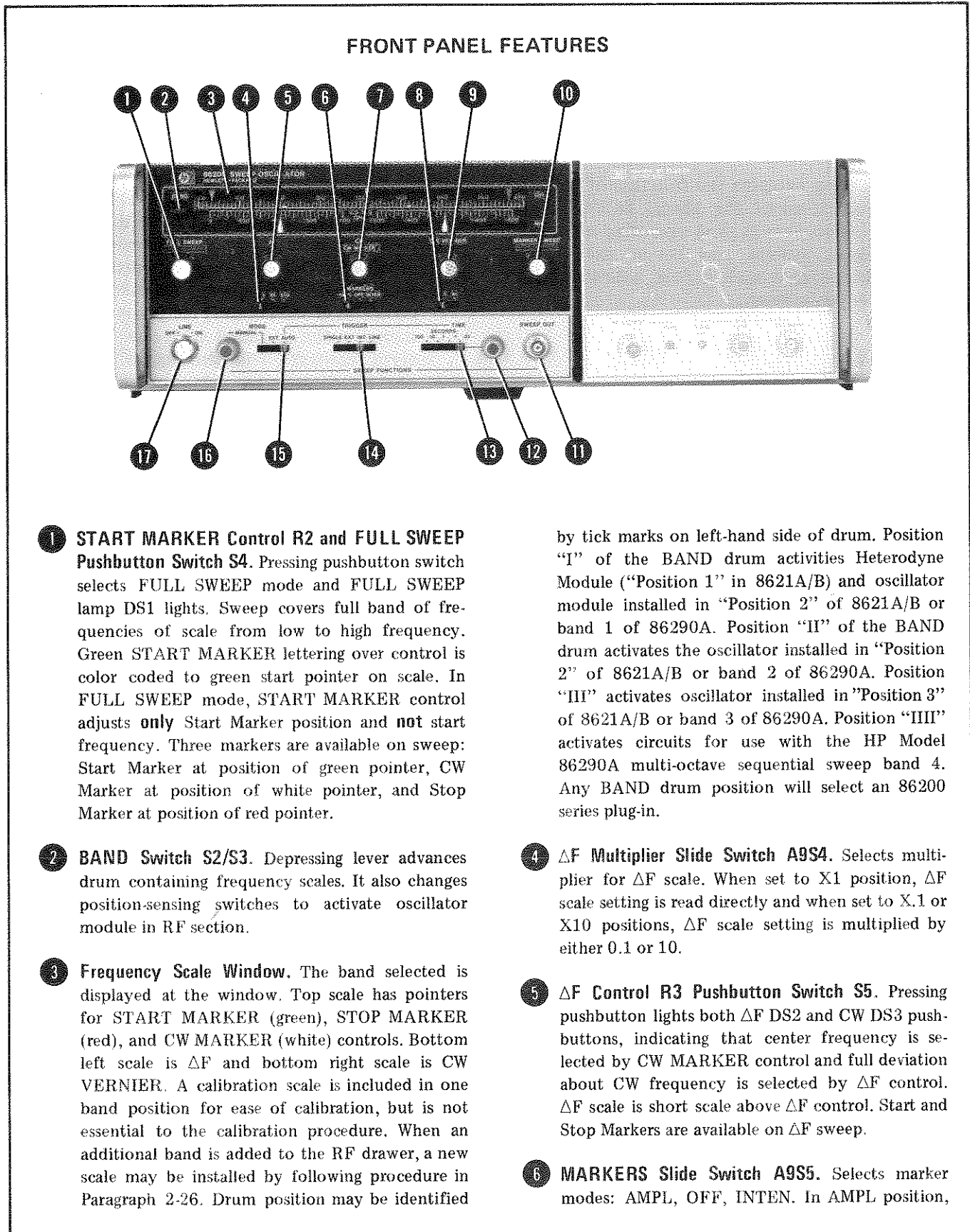

1 START MARKER Control R2 and FULL SWEEP Pushbutton Switch S4. Pressing pushbutton switch selects FULL SWEEP mode and FULL SWEEP lamp DS1 lights. Sweep covers full band of frequencies of scale from low to high frequency. Green START MARKER lettering over control is color coded to green start pointer on scale. In FULL SWEEP mode, START MARKER control adjusts **only** Start Marker position and **not** start frequency. Three markers are available on sweep: Start Marker at position of green pointer, CW Marker at position of white pointer, and Stop Marker at position of red pointer.

2 BAND Switch S2/S3. Depressing lever advances drum containing frequency scales. It also changes position-sensing switches to activate oscillator module in RF section.

3 Frequency Scale Window. The band selected is displayed at the window. Top scale has pointers for START MARKER (green), STOP MARKER (red), and CW MARKER (white) controls. Bottom left scale is ΔF and bottom right scale is CW VERNIER. A calibration scale is included in one band position for ease of calibration, but is not essential to the calibration procedure. When an additional band is added to the RF drawer, a new scale may be installed by following procedure in Paragraph 2-26. Drum position may be identified

by tick marks on left-hand side of drum. Position "I" of the BAND drum activates Heterodyne Module ("Position 1" in 8621A/B) and oscillator module installed in "Position 2" of 8621A/B or band 1 of 86290A. Position "II" of the BAND drum activates the oscillator installed in "Position 2" of 8621A/B or band 2 of 86290A. Position "III" activates oscillator installed in "Position 3" of 8621A/B or band 3 of 86290A. Position "IIII" activates circuits for use with the HP Model 86290A multi-octave sequential sweep band 4. Any BAND drum position will select an 86200 series plug-in.

4 ΔF Multiplier Slide Switch A9S4. Selects multiplier for ΔF scale. When set to X1 position, ΔF scale setting is read directly and when set to X.1 or X10 positions, ΔF scale setting is multiplied by either 0.1 or 10.

5 ΔF Control R3 Pushbutton Switch S5. Pressing pushbutton lights both ΔF DS2 and CW DS3 push-buttons, indicating that center frequency is selected by CW MARKER control and full deviation about CW frequency is selected by ΔF control. ΔF scale is short scale above ΔF control. Start and Stop Markers are available on ΔF sweep.

6 MARKERS Slide Switch A9S5. Selects marker modes: AMPL, OFF, INTEN. In AMPL position,

Figure 3-1. Front Panel Controls, Connectors, and Indicators (1 of 2)

frequency marker is modulated on RF sweep signal. In OFF position, no marker is present. In INTEN position a frequency marker is obtained by intensity modulating Z-axis of oscilloscope or other display instrument on which sweep trace is shown. Intensity modulation signal is available at rear-panel Z-AXIS/MKR/PEN LIFT output J8.

- 7 **CW MARKER Control R4 and CW Pushbutton Switch S6.** Pressing pushbutton switch selects CW mode and CW lamp DS3 lights. White CW MARKER lettering over control is color coded to white pointer on scale and indicates CW frequency. With FULL SWEEP or MARKER SWEEP selected, a CW Marker is available and position of white pointer indicates frequency setting of CW Marker. CW light also comes on when ΔF mode is selected, indicating CW MARKER control selects center frequency of ΔF Sweep.
- 8 **CW VERNIER Multiplier Slide Switch A9S6.** Selects multiplier for CW vernier scale. In X1 position scale is read directly and in X.1 position scale indication is multiplied by 0.1.
- 9 **CW VERNIER Control R5 and Pushbutton Switch S7.** Pressing pushbutton switch connects vernier function for CW or ΔF modes. (DS4 lights.) Vernier control provides fine adjustment of frequencies about CW scale setting. Scale multiplier is controlled by slideswitch below pushbutton control.
- 10 **STOP MARKER Control R6 and MARKER SWEEP Pushbutton Switch S8.** Pressing pushbutton switch selects MARKER SWEEP mode and MARKER SWEEP lamp DS5 lights. Red STOP MARKER lettering over control is color coded to red stop pointer on scale. Sweep is between green START MARKER pointer and red STOP MARKER pointer. CW Marker is available on sweep.
- 11 **SWEEP OUT BNC Connector J1.** Output is linear ramp voltage from zero to 10 volts synchronous with RF sweep signal. Output is available for all operating modes.
- 12 **TIME-SECONDS Vernier Control R8.** Allows sweep time to be adjusted through range selected at TIME-SECONDS slide switch.
- 13 **TIME-SECONDS Slide Switch A9S3.** Sets range of sweep time. Sweep time may be selected from > 100 seconds per sweep (slide switch to left position and vernier control counterclockwise) to < 0.01 seconds per sweep (slide switch to right position and vernier control clockwise).
- 14 **TRIGGER Slide Switch A9S2.** Selects source of sweep-trigger pulse. Switch has spring return in SINGLE sweep mode position. Each time switch is pressed into SINGLE position, a single sweep is initiated; when released, switch returns to EXT. In EXT position, an external trigger pulse may be applied through rear-panel EXT TRIGGER connector. In INT position, sweep trigger pulse is derived from internal sweep oscillator and system is free running. In LINE position, sweep is triggered by power line sine wave peaks.
- 15 **MODE Slide Switch A9S1.** Selects source of sweep signal. In MANUAL position, the control at left of MODE switch controls sweep manually. In EXT position, an external sweep signal may be applied through rear-panel PROGRAMMING connector. In AUTO position, sweep signal is obtained from internal sweep oscillator, producing continuous sweep signal.
- 16 **MANUAL MODE Control R7.** Allows manual sweep of frequency range selected by FULL SWEEP, MARKER SWEEP, or ΔF controls. Selects start frequency in full counterclockwise position; selects stop frequency in full clockwise position. No markers are available.
- 17 **LINE, OFF-ON Switch S1.** Pressing LINE switch applies power to mainframe and plug-in, and switch illuminates DS6. Applying power to instrument always selects FULL SWEEP mode. Line on side of pushbutton indicates ON and OFF position.

Figure 3-1. Front Panel Controls, Connectors, and Indicators (2 of 2)

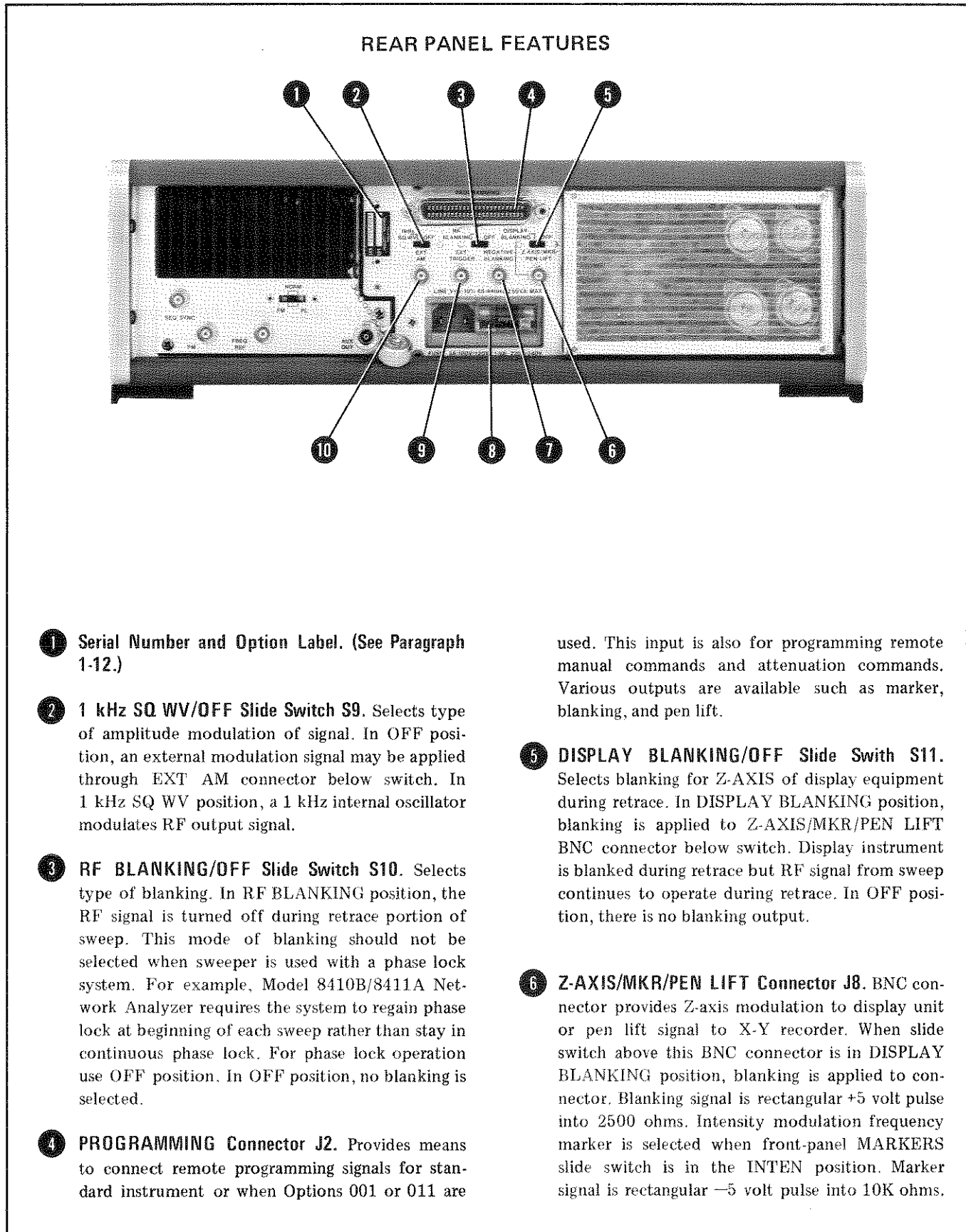

- ❶ **Serial Number and Option Label.** (See Paragraph 1-12.)
- ❷ **1 kHz SQ WV/OFF Slide Switch S9.** Selects type of amplitude modulation of signal. In OFF position, an external modulation signal may be applied through EXT AM connector below switch. In 1 kHz SQ WV position, a 1 kHz internal oscillator modulates RF output signal.
- ❸ **RF BLANKING/OFF Slide Switch S10.** Selects type of blanking. In RF BLANKING position, the RF signal is turned off during retrace portion of sweep. This mode of blanking should not be selected when sweeper is used with a phase lock system. For example, Model 8410B/8411A Network Analyzer requires the system to regain phase lock at beginning of each sweep rather than stay in continuous phase lock. For phase lock operation use OFF position. In OFF position, no blanking is selected.
- ❹ **PROGRAMMING Connector J2.** Provides means to connect remote programming signals for standard instrument or when Options 001 or 011 are

used. This input is also for programming remote manual commands and attenuation commands. Various outputs are available such as marker, blanking, and pen lift.

- ❺ **DISPLAY BLANKING/OFF Slide Switch S11.** Selects blanking for Z-AXIS of display equipment during retrace. In DISPLAY BLANKING position, blanking is applied to Z-AXIS/MKR/PEN LIFT BNC connector below switch. Display instrument is blanked during retrace but RF signal from sweep continues to operate during retrace. In OFF position, there is no blanking output.
- ❻ **Z-AXIS/MKR/PEN LIFT Connector J8.** BNC connector provides Z-axis modulation to display unit or pen lift signal to X-Y recorder. When slide switch above this BNC connector is in DISPLAY BLANKING position, blanking is applied to connector. Blanking signal is rectangular +5 volt pulse into 2500 ohms. Intensity modulation frequency marker is selected when front-panel MARKERS slide switch is in the INTEN position. Marker signal is rectangular -5 volt pulse into 10K ohms.

Figure 3-2. Rear Panel Controls and Connectors (1 of 2)

REAR PANEL FEATURES

- 7 **NEGATIVE BLANKING Connector J5.** BNC connector provides negative polarity blanking during retrace. Blanking signal is rectangular -5 volt pulse into 2400 ohms.
- 8 **Power Line Module FL1.** Line Voltage Selector Card FL1TB1 allows selection of 100, 120, 220, or 240 Vac operation. Instructions for line voltage selection is in Figure 2-1.
- 9 **EXT TRIGGER Connector J4.** BNC connector to input external trigger pulse. This input is selected when the front-panel TRIGGER slide switch is in EXT position. Trigger signal must be greater than +2 Vdc, wider than 0.5 μ sec and not greater than 1 MHz in frequency.
- 10 **EXT AM Connector J3.** BNC connector to input external amplitude modulation signal. This input is selected when rear-panel 1 kHz SQ WV/OFF slide switch is in OFF position.

Figure 3-2. Rear Panel Controls and Connectors (2 of 2)

3-12. REMOTE PROGRAMMING

3-13. Remote programming control is applied through rear-panel PROGRAMMING connector. Tables 3-6 and 3-7 show the input commands and output signals for the programming connector and logic tables for the various commands. Table 3-6 applies to a standard 8620C and Table 3-7 applies when Option 001 is installed.

3-14. Computer or Calculator Programming

3-15. With the addition of Option 001 (A6 BCD Programming printed circuit board) the 8620C may be programmed remotely from a computer or calculator. A simulated sweep mode is provided by sequentially selecting up to 10,000 point frequencies for each band. Band switching, RF attenuation (with 8621B Option 001) and remote/manual operation may also be programmed from the computer.

3-16. The Option 001 BCD programming provides the same capabilities as the HP-IB Option with the exception that no digital marker is available in the programmed sweep modes.

3-17. Hewlett-Packard Interface Bus (HP-IB)

3-18. With the addition of Option 011, a capability is provided to control the sweeper directly via the HP Interface Bus. With Option 011 installed, any sweep function (ΔF , FULL SWEEP, etc.) can be selected and the 8620C will sweep according to the front-panel frequency settings. This option provides a flexible, digital frequency programming with a resolution of 10,000 points per band or 10,000 points across the frequency range set by the front-panel controls. With this operation, a programmable digital marker is available.

3-19. Manual Remote Programming

3-20. A manual remote control system may be used where repetitive operations are performed. The standard 8620C (without Options) contains remote control circuits to select operating mode and frequency range. This mode can be calculator or computer controlled.

3-21. HP-IB REMOTE PROGRAMMING INSTRUCTIONS

NOTE

Examples in this section are written using the HP Model 9830A Calculator with HP Model 59405A Option 030 HP-IB Calculator Interface.

3-22. The 8620C Option 011 sweeper is a remote programmable instrument designed for use in systems that interface with the HP-IB. The front-panel sweep modes that are programmable include FULL SWEEP, ΔF SWEEP, CW, and MARKER SWEEP. Control voltages (from a remote-control source) tune the frequency in FULL SWEEP, ΔF SWEEP, and MARKER SWEEP modes. Also a remote control voltage tunes a remote marker in Local operation. The selection of bands 1 through 4 is programmable and one code is available to place the 8620C in Local band control.

3-23. Interface Modes of Operation

3-24. The HP-IB uses two modes to communicate between instruments: Command Mode and Data Mode. During Command Mode, the system controller addresses the instrument to be programmed. The ASCII "&" character is the example address for the 8620C used in this manual. (Refer to paragraph 3-61.) During Data Mode, codes are sent that are instructions for the instrument addressed to listen. In Data Mode, there are no specific code assignments but devices communicating must agree on the meaning of the codes used.

3-25. The structure for a typical system controller statement would be:

CMD "?U&", "DATA"

Where "?" is the universal ASCII unlisten command to re-initialize the bus, "U" is the calculator talk address, and "&" is the sweeper listen address. The data string follows the address mode. Quotation marks are needed to obtain the keyboard alpha characters and the comma separates the address string from the data or instruction string. The "?U" preceding the 8620C listen address (&) clears the previously addressed instruments and re-addresses the calculator as a talker. (A complete summary of the programming codes is in Table 3-4.)

3-26. Mode Selection

3-27. The HP Model 8620C Option 011 allows several modes of digital and analog frequency control via the HP-IB. These modes are summarized in Table 3-1.

3-28. In Mode M1, the output frequency is totally independent of front-panel control settings and offers 10,000 points of frequency resolution per band for fine frequency selection.

Table 3-1. Program Modes

	Description	ASCII Code
Digital Modes	0.000 Volts → Low End of Band Selected = F_L 10.000 Volts → High End of Band Selected = F_U	M1
	0.000 Volts → Setting of Front Panel CW Control Minus $\frac{\Delta F \text{ Setting}}{2} = F_L$ 10.000 Volts → Setting of Front Panel CS Control Plus $\frac{\Delta F \text{ Setting}}{2} = F_U$	M2
	0.000 Volts → Setting of Front Panel Start Marker = F_L 10.000 Volts → Setting of Front Panel Stop Marker = F_U	M4
Analog Sweep Modes	Analog Sweep of Full Band Selected	M5
	Analog ΔF Sweep Controlled by Front Panel ΔF and CW Controls	M6
	Analog Marker Sweep Controlled by Front Panel Start- and Stop-Marker Controls	M8
Analog CW Mode	Output = Front Panel CW Control Setting	M3 or M7

3-29. For even more resolution, Modes M2 and M4 are available. In these modes, the digital frequency resolution is determined by front-panel frequency control settings on the 8620C. For example, with Mode M2 selected, the front-panel CW control set at 7.5 GHz, and the ΔF control set at 1 GHz, the source would have a digital frequency resolution of 10,000 points between 7.0 GHz and 8.0 GHz or a minimum increment of 100 kHz. The START MARKER and STOP MARKER controls might then be set at 8.0 and 9.0 GHz respectively allowing 10,000 points resolution between those settings in mode M4. In combination, this would provide a resolution or minimum increment capability of 100 kHz from 7.0 — 9.0 GHz in modes M2 and M4.

3-30. Often, it is desirable to be able to view a dynamic swept display, especially during set-up and fine-tuning of a device prior to final test, or as a quick preview to insure no gross discontinuities exist. Modes M5, M6 and M8 allow this flexibility. Mode M5 produces an analog sweep of the full

band selected. Sweep speed, sweep mode, and trigger are all determined by 8620C front-panel controls. Similarly, modes M6 and M8 produce analog ΔF and MARKER SWEEP as determined by appropriate front panel control settings. In these three modes, mainframe markers or a digitally programmed marker are available.

3-31. The capability to place the sweeper in mainframe-controlled CW mode is provided in modes M3 and M7. This allows the operator to manually set CW frequencies or, with a counter, to accurately set the center frequency for ΔF modes.

3-32. If no mode is programmed, the sweeper retains its most recent mode. At the initial turn-on of the sweeper, it is in mode M5.

3-33. BAND PROGRAMMING

3-34. Any of the four bands of the 8620C Option 011 may be selected externally via the HP-IB.

Bands 1 through 4 are designated simply by the ASCII characters "B1" through "B4". In addition, band selection control may be returned to the 8620C front-panel lever by programming "Bφ". At turn-on, the sweeper is in Bφ. As with Mode programming, the sweeper retains its most recent Band instruction if not instructed otherwise.

3-35. Band programming capability is most useful with the multi-band plug-ins such as the 86290A 2–18 GHz plug-in and the 8621B RF drawer with HP 86300 series RF modules. Since the 86200 series of single-band plug-ins will operate equally with any band selected, this instruction is not necessary.

Table 3-2. Band Programming (All Modes)

Description	ASCII Code
Local Band (As Selected by Front-Panel Lever)	Bφ
Band 1	B1
Band 2	B2
Band 3	B3
Band 4	B4

3-36. FREQUENCY (VOLTAGE) PROGRAMMING

3-37. Since the YIG-tuned oscillators in the 8620 plug-ins are essentially VCO's, the programming instructions are in volts or millivolts. This allows the flexibility to use a large number of frequency plug-ins covering a wide variety of bandwidths and absolute frequencies.

3-38. For this reason, it is necessary to use the calculator to convert desired frequency to the required voltage information. This involves a simple conversion equation:

$$V_X = \frac{F_X - F_L}{F_U - F_L} \times 10$$

where F_X = the desired frequency
 F_L = lower frequency limit of the Mode selected (see Table 3-1)
 F_U = upper frequency limit of the Mode selected (see Table 3-1)

3-39. The 8620C Option 011 requires the following format to output the proper frequency:

"Va.bcdE". The letter "E" indicates the end of the voltage string. The decimal point is optional and is disregarded by the sweeper. It processes up to four digits of information and assumes the information is in millivolts with leading zeros suppressed. If more than four digits come down the HP-IB, the 8620C processes only the four digits immediately preceding the "E".

3-40. EXAMPLE: With this information, we are prepared to execute an example using literals for the programming information. In this and following examples, we will use the 86290A 2–18 GHz plug-in with the 8620C. It has four bands covering 2–6.2 GHz, 6–12.4 GHz, 12–18 GHz, and 2–18 GHz respectively. Bands 1 through 3 allow greater resolution than band 4; so, in general, we will be more likely to use these narrower bands than the full 2–18 GHz band.

3-41. Let's assume the desired output frequency is 15 GHz. One approach is to use Mode M1 and band B3. The required voltage is then:

$$\frac{15-12}{18-12} \times 10 = 5.000.$$

The calculator statement required to output 15 GHz is:

```
10 CMD "?U&","M1B3V5,000E"
```

3-42. Note that the order of execution is unimportant, (i.e., GMD "?U&". "B3V5000EM1" would produce the same results). Note also that the 3 zeros must be present after the "5" whether or not the decimal point is present.

Table 3-3. Frequency (Voltage) Programming (Modes M1, M2, M4)

0.000 Volts correspond to low end of band and mode selected		
10.000 Volts correspond to high end of band and mode selected.		
Examples		
Frequency (% of Band/Mode)	Voltage Required (Volts)	ASCII Codes
0%	0	VφE or VφφφφφE
0.1%	0.01	V.010E or V10E
55%	5.5	V5.500E or V5500E
100%	10.000	V:000E or V:000E

3-43. As mentioned above, if more than four voltage digits travel down the HP-IB, only the last four are processed. What if the frequency desired is the same as F_U ? This would require 10.000 volts. But only the last four zeros would be processed resulting in F_L instead of F_U ! To obtain ten volts or more, there is a special ASCII character which signifies 10. The character is the colon (:). For 18 GHz output, the above string would be modified to:

```
10 CMD "?U&", "M1B3V:000E"
```

3-44. MARKERS

3-45. In modes M5, M6 and M8, a digitally programmed marker is available in addition to the standard mainframe markers. The programmable marker is selected by outputting the ASCII character "R" (which also disables the mainframe marker). The frequency of the marker is dictated by a voltage string programmed in the same manner as the digital frequency described above with F_L and F_U being the end points of the band selected. For example, to obtain a marker at 14 GHz in modes M5, M6 or M8, the following string is required:

```
10 CMD "?U&", "B3V3333ER"
```

This will result in either an AMPLitude or INTENsity marker dependent on the setting of the 8620C front-panel switch. In this mode, the mainframe-controlled markers are disabled.

3-46. To enable the mainframe markers and disable the programmable marker, output the ASCII character "L". This places the markers into totally local control.

3-47. FORMAT STATEMENTS

3-48. In order to program the frequency with variables, a format statement is required to insure the proper characters and sequence are used on the HP-IB. For the Band and Mode information, suppression of leading zeros is required. With the frequency information in volts, three digits are required after the decimal point and again it is desirable to suppress leading zeros.

3-49. EXAMPLE: In this example, the variable B is defined as the band number, X is defined as the voltage required, and mode M1 is used to output a CW frequency. The following program steps would output the proper frequency:

9825A

```
0:
cmd7, "?U&" ;fmt1"M
1B",f.0, "V",f.3,
"E"†
1:
wrt 706.1,B,x†
```

9830A

```
10 CMD "?U&"
20 OUTPUT (13,30)B,X
30 FORMAT "M1B",F1000.0, "V",F1000.3,"E"
```

3-50. There are two ways to handle ≥ 10 volts when programming in variables. If F_U is desired to the accuracy of the sweeper, a conditional statement resetting X to 9.999 whenever it is greater than or equal to 9.9995 will produce virtually 10 volts and a frequency within 0.005% of that produced with 10.000 volts. For frequency correction (see example below) or where frequencies $> F_U$ are required, a conditional output statement may be used. If X is ≥ 9.9995 , then the program would branch to the following output steps:

9825A

```
8:
cmd7, "?U&" ;fmt2"M
1B",f.0, "V:" ,f.3
, "E"†
9:
wrt 706.2,B,x-10†
```

9830A

```
70 CMD "?U&"
80 OUTPUT (13,90)B,X-10
90 FORMAT "M1B" ,F1000.0, "V:" ,F1000.3,"E"
```

3-51. HP 8620C HP-IB Configuration Code

3-52. The programming configuration code for the 8620C, as documented in IEEE Standard 488-1975 for the HP-IB, and selected by the calculator is:

```
SH0 AH1 T0 L2 SR0 RL2 PP0 DC0 DT0 C0 E1
```

3-53. Remote/Local Operation

3-54. The term remote/local refers to which device is controlling the 8620C sweeper. In local, the front panel of the sweeper has control; in remote,

Table 3-4. Summary of Programming Codes

CODES	FUNCTION	DESCRIPTION
MODE SELECTED	M1 FULL SWEEP	Remote control voltage of 0V corresponds to the low frequency end of the band and control voltage of 10V represents the high frequency end of the band.
	M2 ΔF	Remote control voltage of 0V represents $CW - (\Delta F \text{ WIDTH}/2)$ and control voltage of 10V represents $CW + (\Delta F \text{ WIDTH}/2)$.
	M3/M7 CW	Frequency corresponds to position of CW pointer.
	M4 MARKER SWEEP	Remote control voltage of 0V represents the START pointer frequency and control voltage of 10V represents the STOP pointer frequency.
	M5 FULL SWEEP	FULL SWEEP control operates same as in local operation.
	M6 ΔF	ΔF control operates same as in local operation.
	M8 MARKER SWEEP	MARKER SWEEP control operates same as in local operation.
	BAND SELECTED	B1 Band 1 select
B2 Band 2 select		
B3 Band 3 select		
B4 Band 4 select		
B \emptyset Local Control		Front-panel BAND lever selects the band.
MARKER MODE	L LOCAL MARKERS only	
	R REMOTE MARKERS only	Markers selected in Sweep Modes M5, M6, and M8.

the calculator or computer is in control. Three conditions of Local/Remote/Return-to-Local are explained below.

3-55. Power-On Conditions. When the 8620C is first turned on, it is in Local Control.

3-56. Remote Control. To set the 8620C to Remote, the HP-IB must be in remote (REN true) and the 8620C must receive its listen address. REN must be held true continuously to remain in remote control. When set to Remote control, the programming and conditions will be as follows:

Mode: Determined by mode set on front panel; Codes M5, M6, M7, or M8.

Band: Set by front-panel lever switch; Code B0.

Control Voltage: V is undefined.

Marker: Set to local; Code L.

3-57. Return-to-Local. The 8620C may be returned to local control by setting REN false, turning the 8620C or controller power OFF, or removing the HP-IB cable from either the 8620C or controller.

3-58. ADDRESSING

3-59. All instruments using the HP-IB share a common set of data and control lines. Since the controller must communicate with individual instruments on the bus, each instrument is given a unique address. The address is a seven-bit ASCII character (American Standard Code for Information Interchange) that the instrument recognizes and responds to.

3-60. Before addressing an instrument, the controller first pulls the ATN (attention) control line low (true) and then, during Command Mode, the address code is transmitted. When the instrument acknowledges receipt of the address (through the handshake lines), the controller releases the ATN line and clears the address code. The 8620C can be addressed (or unaddressed) in both local and remote control modes.

3-61. Listen Address Codes

3-62. In an HP-IB system, the 8620C Option 011 functions as a Listener. A listener is a device

capable only of receiving data or commands from other instruments. The 8620C is enabled as a listener when the controller transmits the correct listen-address code. The 8620C HP-IB interface ignores all commands or addresses relating to talkers or controllers.

3-63. The seven-bit codes reserved for listen addresses and the corresponding ASCII character are listed in Table 3-5. (A total of 31 addresses is available.) Bits one through five of the data (DIO) lines are set either high or low to select the address. The address code is set with five address switches. A12SW1-1 — A12SW1-5 on the A12 HP-IB Interface Assembly. A contact to ground (low) indicates a true state. (Refer to Figure 2-8.)

3-64. The nominal 8620C listen address is ASCII Character "&" or octal 046. The address may be changed by the system designer since the 8620C does not require any particular address. When changing addresses, be sure the new address does not conflict with those of other instruments using the HP-IB.

3-65. Unaddressing

3-66. Once the 8620C is addressed, it remains addressed until it is unaddressed or cleared by the system controller. There are several ways to unaddress the 8620C:

- a. Sending Unlisten command (077 octal ASCII ?). This command must be given in the Command Mode (ATN true).
- b. Pulling Interface Clear (IFC) line true. This asynchronously clears all instruments on the HP-IB.
- c. Turning 8620C mainframe OFF.

3-67. RESPONSE TIMING CONSIDERATION

3-68. The time required by the 8620C to accept each character is approximately 5 μ sec. Any change of frequency in the plug-in will need 10 msec or less for stepping across the entire band and proportionally less time for smaller changes in frequency. (This time delay is required by the 8620C, after the command is received, and is due to inherent delays in the oscillator.)

Table 3-5. Listen Address Codes

Listen Addresses					
Bits					ASCII Character
b ₅	b ₄	b ₃	b ₂	b ₁	
0	0	0	0	0	SP
0	0	0	0	1	!
0	0	0	1	0	"
0	0	0	1	1	
0	0	1	0	0	S
0	0	1	0	1	%
0	0	1	1	0	&
0	0	1	1	1	'
0	1	0	0	0	(
0	1	0	0	1)
0	1	0	1	0	*
0	1	0	1	1	+
0	1	1	0	0	,
0	1	1	0	1	-
0	1	1	1	0	.
0	1	1	1	1	/
1	0	0	0	0	0
1	0	0	0	1	1
1	0	0	1	0	2
1	0	0	1	1	3
1	0	1	0	0	4
1	0	1	0	1	5
1	0	1	1	0	6
1	0	1	1	1	7
1	1	0	0	0	8
1	1	0	0	1	9
1	1	0	1	0	:
1	1	0	1	1	;
1	1	1	0	0	<
1	1	1	0	1	=
1	1	1	1	0	>

3-69. BUS OPERATING CONSIDERATIONS

3-70. When a device capable of activating IFC is powered ON during system operation, it may cause the active controller on the bus to relinquish control, resulting in errors. The controller must transmit IFC to regain active control.

3-71. Prior to addressing new listeners it is recommended that all previous listeners be unaddressed using the Unlisten Command "?".

3-72. OPERATOR'S MAINTENANCE

3-73. Operator's maintenance consists of replacing line fuse and indicator lamps, cleaning the

air filter, and changing the frequency scales. These items are discussed in the following paragraphs.

3-74. Fuses



Make sure that only fuses with the required rated current and of the specified type are used for replacement. The use of repaired fuses and other short-circuiting of fuse-holders should be avoided.

3-75. There are five fuses in the 8620C. The main ac line fuse is located at the back of the instrument next to the line cord jack. The ac line cord must be removed to gain access to the fuse compartment. The fuse may be removed by pulling the lever inside the fuse compartment. (See Figure 2-1.) For the 100 or 120 Vac supply source, use a 3-amp line fuse; for the 220 or 240 Vac supply, use a 1.5 amp line fuse. There are four other fuses inside the instrument. Access to these requires removing instrument top cover. These fuses should be replaced only by qualified service personnel who are aware of the hazard involved. Replacement of these fuses is covered in Section VIII.

3-76. Air Filter



To avoid personal injury, set LINE switch to OFF and remove AC line cord from rear of instrument before removing fan filter.

3-77. The fan has a filter attached from the outside for ease of cleaning or replacement. To service the filter, remove the four screws holding filter to rear panel and either replace it with the appropriate part listed in Section VI or clean it, using a solution of warm water and soap.

3-78. Lamp Replacement

3-79. The five front-panel lamps located in the mode selector pushbutton switches and the LINE lamp are replaceable from the front. (See Figure 3-3 for procedure.)

3-80. Frequency Scale Installation

3-81. See procedure in Paragraph 2-26.

Table 3-6. Remote Programming Using Standard 8620C (1 of 2)

<i>Programming Connector Input Commands and Output Signals</i>			
Pin on J2*	Input Commands or Output Signals	Pin on J2*	Input Commands or Output Signals
13	Band Select	32	Marker Sweep Select
14	Band Select	34	Stop Sweep Pulse
16	Pen Lift Common	36	40 dB
17	Z Axis/Mkr/Pen Lift	37	20 dB
19	+20V	38	10 dB
20	+5V	39	Remote Band Enable
26	Sequential Sync	40	RF Blanking – Output
27	Marker	41	Remote Attn Enable – Input
28	External Sweep	43	Ground
29	Δ F Mode Select	44	-10V
30	CW Mode Select	45	-40V
31	Full Sweep Select		
			*Pins not shown are unused in this application.

NOTE

8621A/B Option 010 programmable 70 dB attenuator is required to accept RF attenuation control signals from J2 pins 36 through 38.

RF Output Attenuation Programming

RF Output Attenuation	10 dB line J2 Pin 38	20 dB line J2 Pin 37	40 dB line J2 Pin 36	REMOTE ATTN SELECT J2 Pin 41
0 dB	X	X	X	1
0 dB	0	0	0	0
10 dB	1	0	0	0
20 dB	0	1	0	0
30 dB	1	1	0	0
40 dB	0	0	1	0
50 dB	1	0	1	0
60 dB	0	1	1	0
70 dB	1	1	1	0

Table 3-6. Remote Programming Using Standard 8620C (2 of 2)

Band Select Programming

Band	A J2 Pin 13	B J2 Pin 14	Remote Band Select J2 Pin 39
X	X	X	1
1	1	1	0
2	1	0	0
3	0	0	0
4	0	1	0

Manual Remote Mode Programming

Mode Selected	J2 Pin 29	J2 Pin 30	J2 Pin 31	J2 Pin 32
FULL SWEEP	1	1	0	1
MARKER SWEEP	1	1	1	0
CW	1	0	1	1
ΔF	0	1	1	1

NOTE

Each mode is selected by a momentary or steady state closure to ground (0).
1 indicates no closure to ground. Ground is pin J2-43.

NOTES

1 = Open or $\geq +2.0$ Vdc.

0 = Closure to ground (pin J2-43) or $\leq +0.8$ Vdc.

Table 3-7. Remote Programming Using 8620C Option 001 (1 of 2)

Programming Connector Input Commands and Output Signals					
Pin on J2*	Input Commands or Output Signals	Pin on J2*	Input Commands or Output Signals		
1	BCD8, 8 Volts	26	Sequential Sync		
2	BCD4, 4 Volts			27	Marker
3	BCD2, 2 Volts			28	External Sweep
4	BCD1, 1 Volt			29	ΔF Mode Select
5	BCD8, 0.8 Volt			30	CW Mode Select
6	BCD4, 0.4 Volt			31	FULL SWEEP Mode Select
7	BCD2, 0.2 Volt			32	MARKER SWEEP Mode Select
8	BCD1, 0.1 Volt			33	BCD2, 0.002 Volt
9	BCD8, 0.08 Volt			34	Stop Sweep Pulse
10	BCD4, 0.04 Volt			35	BCD4, 0.004 Volt
11	BCD2, 0.02 Volt			36	40 dB
12	BCD1, 0.01 Volt			37	20 dB
13	Band Select	38	10 dB		
14	Band Select	39	Remote Band Enable - Input		
15	Remote D/A Enable	40	RF Blanking - Output		
16	Pen Lift Common	41	Remote Attn Enable		
17	Z Axis/Mkr/Pen Lift	42	BCD8, 0.008 Volt		
18	BCD1, 0.001 Volt - Input	43	Ground		
19	+20V	44	-10V		
20	+5V	45	-40V		

* Pins not shown are unused in this application

NOTES

- 8620C Option 001 digital-to-analog converter is required to accept frequency control signals from J2 pins 1 thru 12, 18, 33, 35, and 42.
- 8621A/B Option 010 programmable 70 dB attenuator is required to accept RF attenuation control signals from J2 pins 36 thru 38.

Band Select Programming

Band	A J2 Pin 13	B J2 Pin 14	Remote Band Select J2 Pin 39
X	X	X	X
1	1	1	0
2	1	0	0
3	0	0	0
4	0	1	0

Table 3-7. Remote Programming Using 8620C Option 001 (2 of 2)

<i>RF Output Attenuation Programming</i>				
RF Output Attenuation	10 dB line	20 dB line	40 dB line	REMOTE ATTN SELECT
	J2 Pin 38	J2 Pin 37	J2 Pin 36	J2 Pin 41
0 dB	X	X	X	1
0 dB	0	0	0	0
10 dB	1	0	0	0
20 dB	0	1	0	0
30 dB	1	1	0	0
40 dB	0	0	1	0
50 dB	1	0	1	0
60 dB	0	1	1	0
70 dB	1	1	1	0

Manual Remote Programming

Mode Selected	J2 Pin 29	J2 Pin 30	J2 Pin 31	J2 Pin 32
FULL SWEEP	1	1	0	1
MARKER SWEEP	1	1	1	0
CW	1	0	1	1
ΔF	0	1	1	1

NOTES

1. Analog and digital sweep modes are available. The digital sweep mode is provided when the digital-to-analog converter is enabled.
2. The bandwidth is dependent upon the front-panel control when the digital-to-analog converter is enabled.
3. Each mode is selected by a momentary or steady state closure to ground (0). 1 indicates no closure to ground. Ground is pin J2-43.

NOTES

1 = Open or $\geq +2.0$ Vdc.

0 = Closure to ground (pin J2-43) or $\leq +0.8$ Vdc.

Table 3-8. Programming Connector Commands and Signals Available for Additional Interface Capabilities

Pin on J2*		Pin on J2*			
16	Pen Lift Common Z-Axis/Mkr/Pen Lift	} Outputs	36 } 40 dB 37 } 20 dB 38 } 10 dB		
17				RF ATTENUATION**	
19					40 RF Blanking — Output
20					
26	43 Ground				
27		44 -10V } Outputs			
28			45 -40V } Outputs		
34				50 External Trig (8410B) — Input	

* Pins and functions shown are only lines available for extended capabilities when using cable adapter HP 8120-2207. (See paragraph 2-39 for installation.)

** 8621B Option 010 programmable 70 dB attenuator is required to accept RF attenuation control signals from J2 pins 36, 37, and 38.

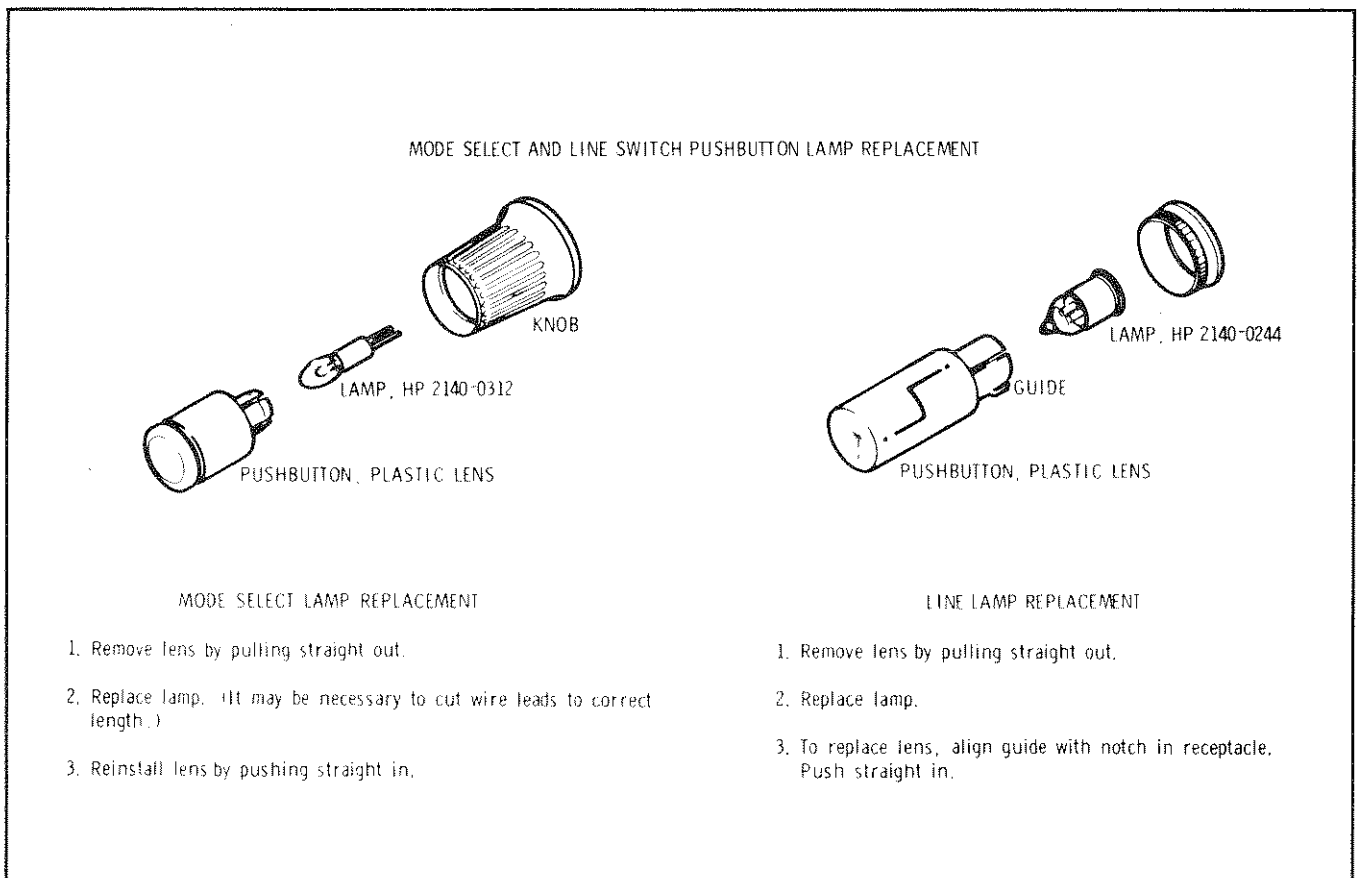

Figure 3-3. Lamp Replacement

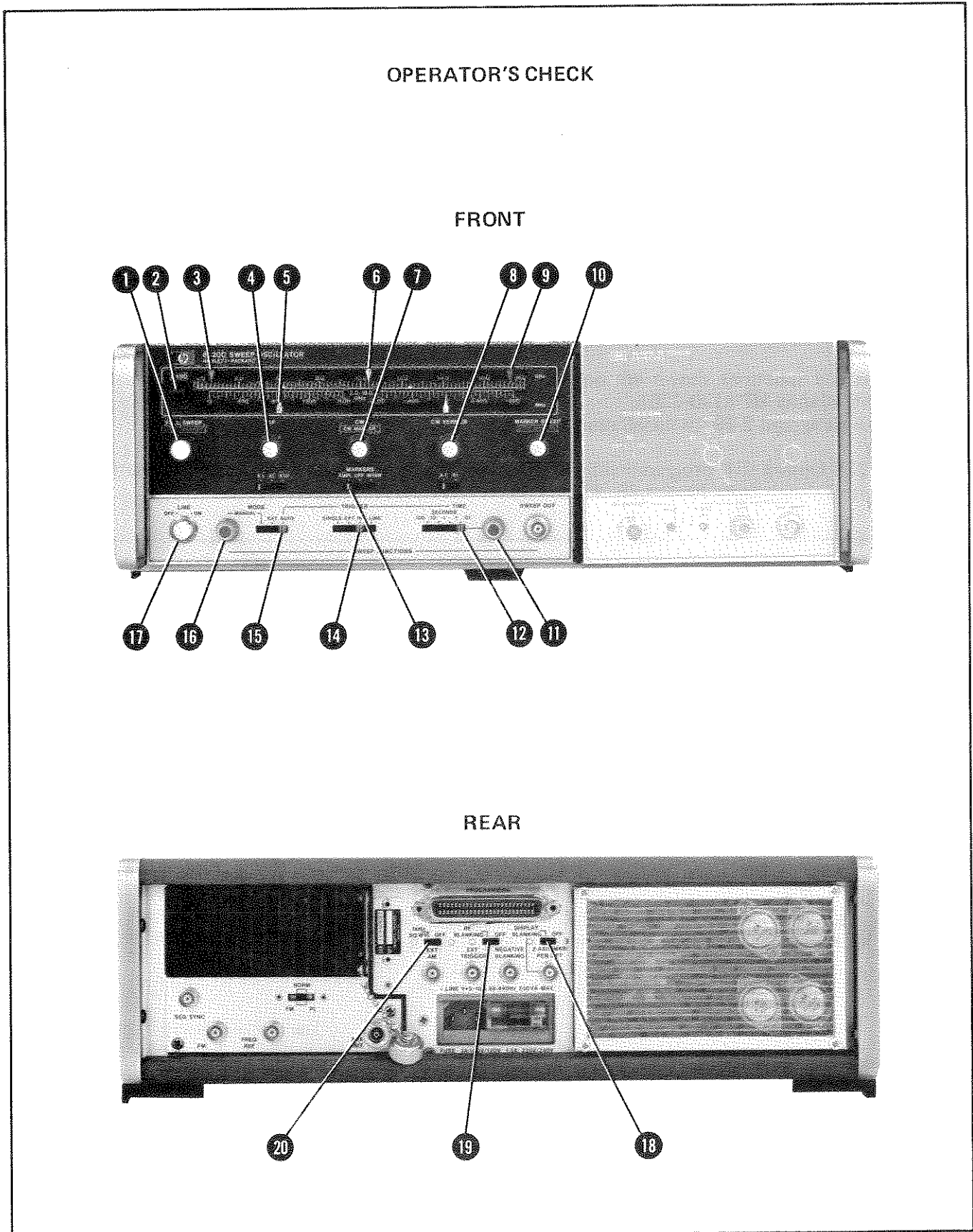

Figure 3-4. Operator's Check (1 of 3)

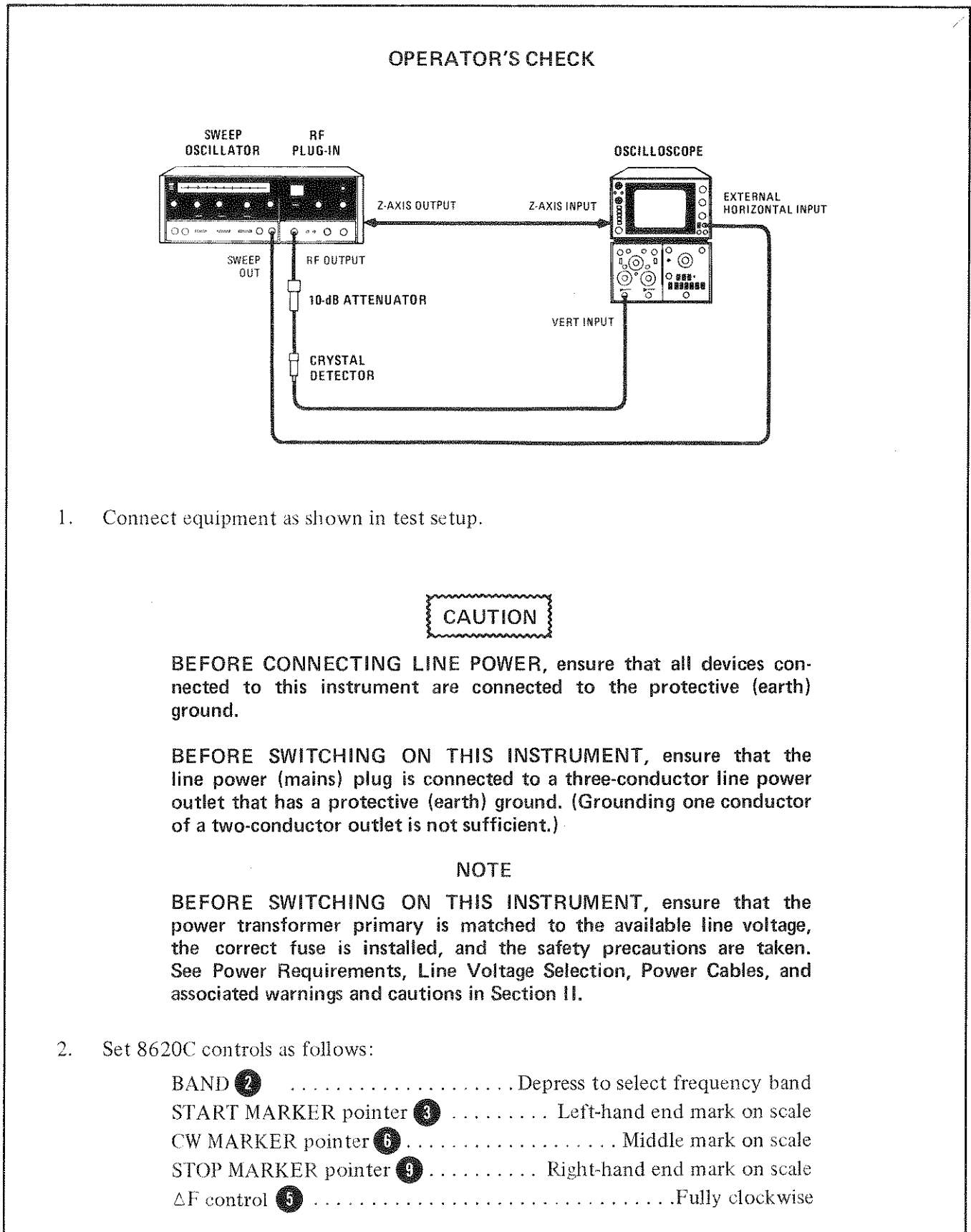

Figure 3-4. Operator's Check (2 of 3)

OPERATOR'S CHECK

CW VERNIER pointer ⑧ Center or 0
 MARKERS ⑬ AMPL
 MODE ⑮ AUTO
 TRIGGER ⑭ INT
 TIME SECONDS ⑫ 1 - .01
 TIME-SECONDS Vernier ⑪ Fully clockwise
 1 kHz SQ WV/OFF (Rear Panel) ⑳ OFF
 DISPLAY BLANKING/OFF (Rear Panel) ⑱ .. DISPLAY BLANKING
 RF BLANKING/OFF (Rear Panel) ⑲ OFF

3. Press LINE pushbutton switch ⑰ to turn on instrument; LINE and FULL SWEEP ① pushbuttons should light.
4. Set controls on RF Plug-in to obtain an RF signal output. Oscilloscope trace should show detected RF signal output below zero-volt reference. There should be no discontinuity in swept trace across band. Three markers should appear on sweep: Start Marker at position indicated by green pointer ③, CW Marker at position indicated by white pointer ⑥, and Stop Marker at position indicated by red pointer ⑨.
5. Press MARKER SWEEP pushbutton ⑩; pushbutton should light. CW Marker should appear at center of oscilloscope trace as indicated by position of white CW MARKER pointer ⑥. Sweep should begin at frequency setting of START MARKER pointer ③ and end at frequency setting of STOP MARKER pointer ⑨.
6. Set MODE switch ⑮ to MANUAL position and adjust MANUAL control ⑯. Trace dot should move across oscilloscope CRT. No markers are available in Manual mode.
7. Set MODE switch to AUTO.
8. Press CW pushbutton ⑦; pushbutton should light and trace on oscilloscope should be a dot. Change frequency setting of CW MARKER pointer and dot should move across oscilloscope CRT.
9. Press CW VERNIER pushbutton ⑧; pushbutton should light. Adjust CW VERNIER control and oscilloscope dot should move across CRT at a very slow rate and through a narrow range. Press CW VERNIER pushbutton again to disable CW VERNIER function.
10. Press ΔF pushbutton ④; ΔF and CW pushbuttons should light. Swept trace below zero volt reference should be displayed on oscilloscope CRT.

NOTE

In ΔF mode, two markers are available by adjusting the START MARKER and STOP MARKER controls.

Figure 3-4. Operator's Check (3 of 3)

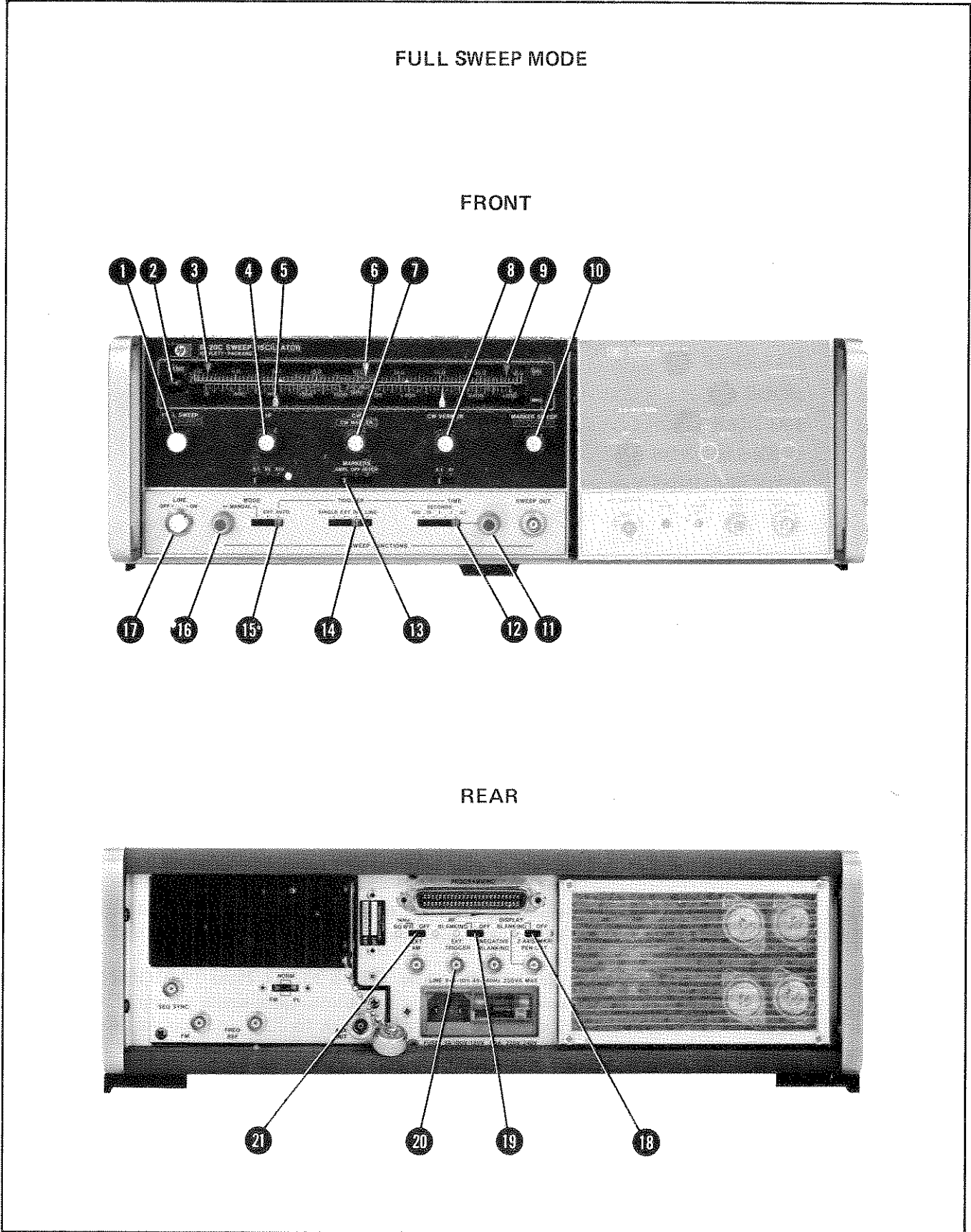

Figure 3-5. Full Sweep Mode (1 of 2)

FULL SWEEP MODE

1. Connect sweep oscillator as shown in Figure 3-4 test setup.
2. Set 8620C controls as follows:

BAND ② Depress to select frequency band
 START MARKER pointer ③ Left-hand end mark on scale
 CW MARKER pointer ⑥ Middle mark on scale
 STOP MARKER pointer ⑨ Right-hand end mark on scale
 ΔF control ⑤ Fully clockwise
 CW VERNIER control ⑧ Fully clockwise
 MARKERS ⑬ INTEN
 MODE ⑮ AUTO
 TRIGGER ⑭ INT
 TIME-SECONDS ⑫1 — .01
 TIME-SECONDS Vernier ⑪ Fully clockwise
 1 kHz SQ WV/OFF (Rear Panel) ⑳ OFF
 RF BLANKING/OFF (Rear Panel) ⑲ OFF
 DISPLAY BLANKING/OFF (Rear Panel) ⑱ . DISPLAY BLANKING

3. Press LINE pushbutton switch ⑰ to turn on instrument; LINE and FULL SWEEP push-buttons should light.
4. Set controls on RF plug-in to obtain an RF signal output. Oscilloscope trace should show detected RF signal output below zero-volt reference. There should be no discontinuity in swept trace across band. Three bright marker spots should appear on trace: Start Marker at position of green pointer ③, CW Marker at position of white pointer ⑥ and Stop Marker at position of red pointer ⑨. Set MARKERS switch ⑬ to AMPL to obtain amplitude markers on trace.
5. Sweep width is full band of frequencies of scale selected and cannot be changed.
6. Band may be swept manually by setting MODE switch ⑮ to MANUAL and adjusting MANUAL control ⑯ through its range. Nor markers are available in Manual mode.
7. Select SINGLE sweep as follows: Set MODE switch ⑮ to AUTO. Press TRIGGER switch ⑭ to SINGLE position and release. Repeat this to obtain each single sweep. External (EXT) trigger mode is available by setting TRIGGER switch to EXT and applying external trigger pulse to rear-panel EXT TRIGGER ㉑. Sweep may be triggered from ac line by setting TRIGGER switch to LINE.

Figure 3-5. Full Sweep Mode (2 of 2)

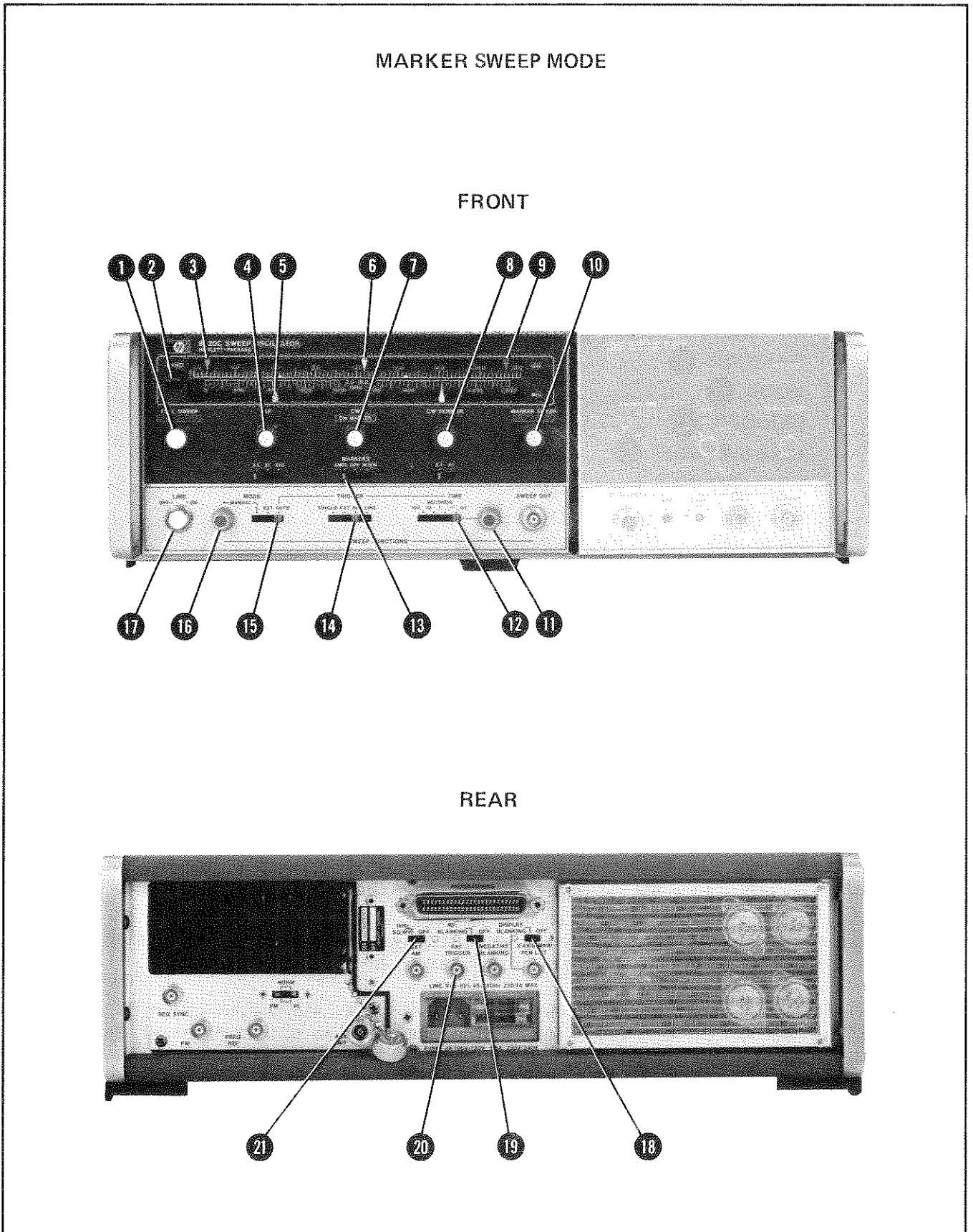

Figure 3-6. Marker Sweep Mode (1 of 2)

MARKER SWEEP MODE

1. Connect sweep oscillator as shown in Figure 3-4 test setup.
2. Set 8620C controls as follows:

BAND ② Depress to select frequency band
 START MARKER pointer ③ Left-hand end mark on scale
 CW MARKER pointer ⑥ Middle mark on scale
 STOP MARKER POINTER ⑨ Right-hand end mark on scale
 ΔF Control ⑤ Fully clockwise
 CW VERNIER control ⑧ Fully clockwise
 MARKERS ⑬ INTEN
 MODE ⑮ AUTO
 TRIGGER ⑭ INT
 TIME-SECONDS ⑫1 – .01
 TIME-SECONDS Vernier ⑪ Fully clockwise
 1 kHz SQ WV/OFF (Rear Panel) ⑳ OFF
 RF BLANKING/OFF (Rear Panel) ⑲ OFF
 DISPLAY BLANKING/OFF (Rear Panel) ⑱ DISPLAY BLANKING

3. Press LINE pushbutton switch ⑰ to turn on instrument; LINE and FULL SWEEP push-buttons should light.
4. Press MARKER SWEEP pushbutton ⑩ ; pushbutton should light.
5. Set controls on RF plug-in to obtain an RF signal output. Oscilloscope trace should show detected RF signal output below zero-volt reference. There should be no discontinuity in swept trace across band. Bright marker spot should be at middle of trace.
6. Sweep width is changed by START MARKER ① and STOP MARKER ⑩ controls marker position is changed by CW MARKER control ⑦ .
7. Set MARKERS switch ⑬ to AMPL to obtain amplitude markers on trace.
8. Band may be swept manually by setting MODE switch ⑮ to MANUAL and adjusting MANUAL control ⑯ through its range. No markers are available in Manual mode.
9. Select SINGLE sweep as follows: Set MODE switch ⑮ to AUTO. Press TRIGGER switch ⑭ to SINGLE position and release. Repeat this to obtain each single sweep. External (EXT) trigger mode is available by setting TRIGGER switch to EXT and applying external trigger pulse to rear-panel EXT TRIGGER input ⑳ . Sweep may be triggered from ac line by setting TRIGGER switch to LINE.

Figure 3-6. Marker Sweep Mode (2 of 2)

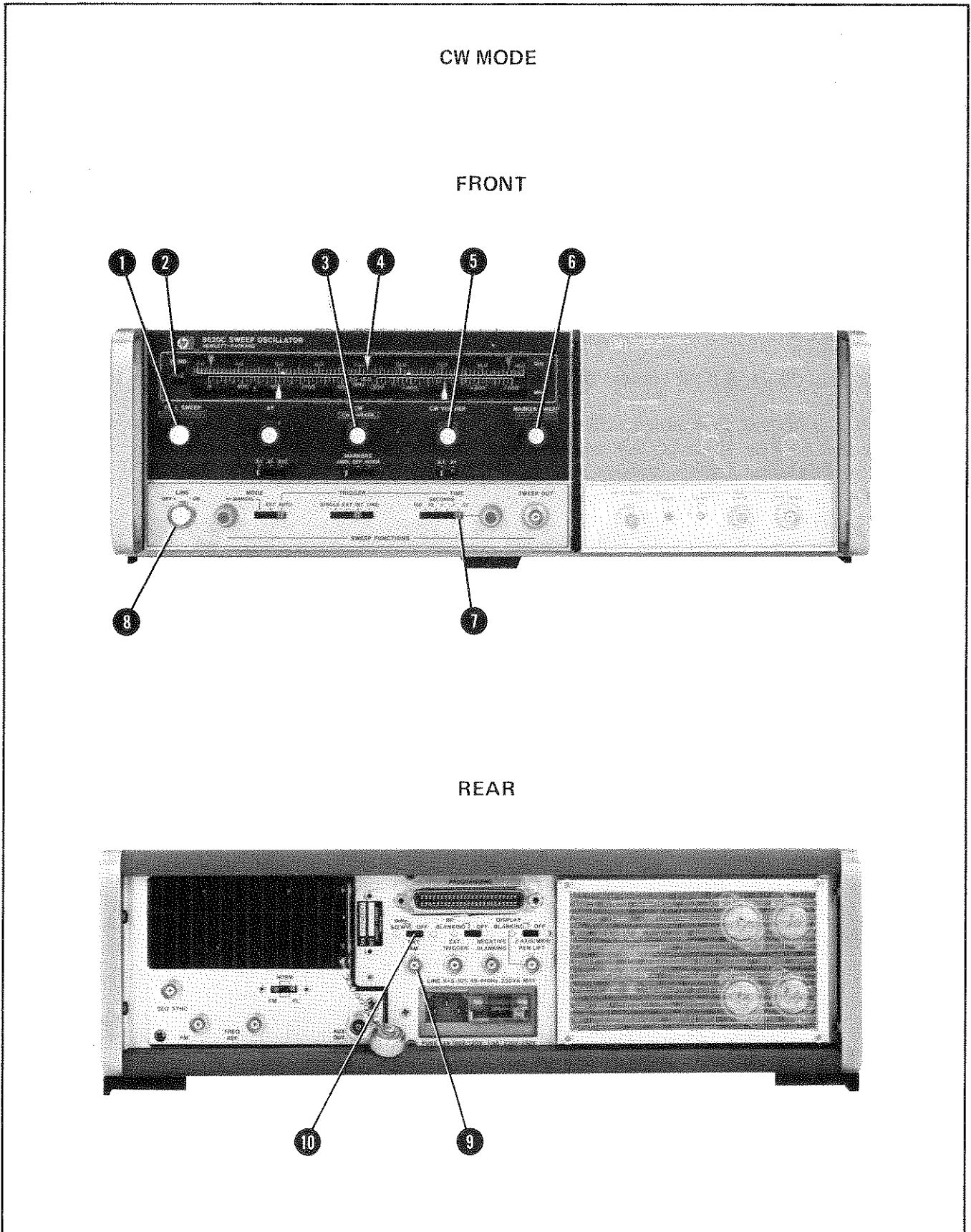

Figure 3-7. CW Operating Mode (1 of 2)

CW MODE

1. Connect sweep oscillator and set 8620C controls as shown in Figure 3-4.
2. Press LINE pushbutton switch ⑧ to turn on instrument; LINE and FULL SWEEP ① pushbuttons should light.
3. Depress BAND switch ② until correct band is displayed at window.
4. Press CW pushbutton ③. Pushbutton should light and trace on oscilloscope should be a dot. Change frequency with CW MARKER control and dot should move across oscilloscope CRT.
5. Rotate CW MARKER control ③ to set CW pointer ④ at selected frequency on scale.
6. If it is desired to modulate CW signal, set rear-panel 1kHz SQ WV/OFF slide switch ⑩ to either OFF or 1kHz SQ WV position. In OFF position, a modulation signal may be applied from external source through rear-panel EXT AM connector ⑨. In 1kHz SQ WV position, a 1 kHz internal oscillator modulates RF output signal.
7. To expand CW frequency dial, press CW VERNIER pushbutton switch ⑤. CW VERNIER control allows CW frequency to be changed by small amounts. Set X.1—X1 multiplier slide switch ⑦, located below CW VERNIER control, for bandspread desired.

Figure 3-7. CW Operating Mode (2 of 2)

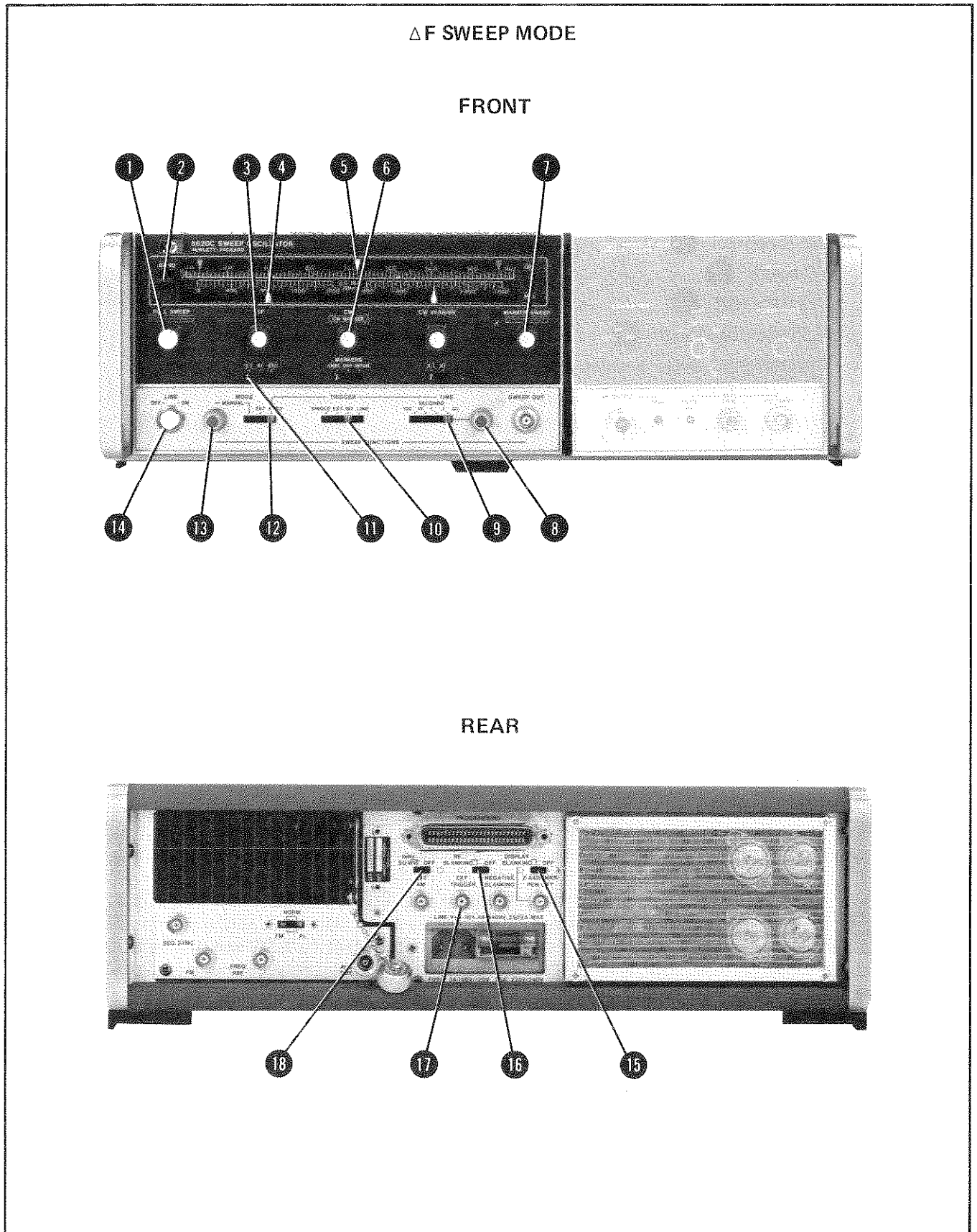

Figure 3-8. ΔF Sweep Mode (1 of 2)

ΔF SWEEP MODE

1. Connect sweep oscillator as shown in Figure 3-4 test setup.
2. Set 8620C controls as follows:

BAND ② Depress to select desired frequency band
 CW MARKER pointer ⑤ Selected ΔF center frequency
 ΔF control ④ Fully clockwise
 MODE ⑫ AUTO
 TRIGGER ⑩ INT
 TIME-SECONDS ⑨ 1 - .01
 TIME-SECONDS Vernier ⑧ Fully clockwise
 1 kHz SQ WV/OFF (Rear Panel) ⑮ OFF
 RF BLANKING/OFF (Rear Panel) ⑮ OFF
 DISPLAY BLANKING/OFF (Rear Panel) ⑮ DISPLAY BLANKING

3. Press LINE pushbutton switch ⑭ to turn on instrument; LINE and FULL SWEEP push-buttons should light.
4. Set controls on RF plug-in to obtain an RF signal output.
5. Press ΔF pushbutton switch ③ ; ΔF and CW ⑥ pushbuttons should light.
6. CW MARKER control ⑥ sets center frequency of sweep. START MARKER ⑰ and STOP MARKER ⑦ controls adjust position of markers.
7. Set ΔF control ③ and ΔF multiplier slide switch ⑪ below ΔF control for selected deviation from center frequency. Trace on oscilloscope should display across the swept band.
8. Band may be swept manually by setting MODE switch ⑫ to MANUAL and adjusting MANUAL control ⑬ through its range. No markers are available in MANUAL mode.
9. Select SINGLE sweep as follows: Set MODE switch ⑫ to AUTO. Press TRIGGER switch ⑩ to SINGLE position and release. Repeat this to obtain each single sweep. External (EXT) trigger mode is available by setting TRIGGER switch to EXT and applying external trigger pulse to rear-panel EXT TRIGGER input ⑰ . Sweep may be triggered from ac line by setting TRIGGER switch to LINE.

Figure 3-8. ΔF Sweep Mode (2 of 2)

SECTION IV PERFORMANCE TESTS

4-1. INTRODUCTION

4-2. The procedures in this section test the electrical performance of the 8620C Sweep Oscillator/RF Unit combination. The performance standards are the specifications in Section I of the applicable RF Unit manual. All tests can be performed without access to the interior of the instruments.

4-3. EQUIPMENT REQUIRED

4-4. Equipment required for the performance tests is listed in the Recommended Test Equipment table in Section I of this manual and the applicable RF Unit manual. Any equipment that satisfies the critical specifications given in the tables may be substituted for the recommended model(s).

4-5. TEST RESULTS

4-6. If the 8620C Sweep Oscillator/RF Unit combination fails to meet performance test speci-

fications, and a circuit malfunction is not suspected, refer to 8620C Adjustments (Section V) in this manual. If, after 8620C Adjustments have been performed, the instrument combination still fails to meet specifications, refer to RF Unit Adjustments in the applicable RF Unit manual. If a circuit malfunction is suspected, refer to troubleshooting section of this manual or applicable RF Unit manual.

NOTE

To avoid parallax when setting a pointer to a graticule mark, view the pointer and scale directly from the front of the instrument panel.

NOTE

Press LINE pushbutton on 8620C to turn power ON and allow 30 minutes warm-up time.

PERFORMANCE TESTS

4-7. FULL SWEEP TEST

SPECIFICATION: **Full Sweep:** Sweeps the full band as determined by plug-in and band select lever.
End-point Accuracy: Refer to RF Unit Specifications, same as frequency accuracy.

DESCRIPTION: Full Sweep end-point accuracy is checked in FULL SWEEP using Manual mode.

EQUIPMENT: Refer to RF Unit Frequency Range and Accuracy performance test.

PROCEDURE: In FULL SWEEP, Manual mode, check low end and high end of band for end-point accuracy according to RF Unit performance test procedure for manual sweep accuracy; Frequency Range and Accuracy Test.

4-8. MARKER SWEEP TEST

SPECIFICATION: **Marker Sweep:** Sweeps from START MARKER to STOP MARKER frequency settings.
Range: Both settings continuously and independently adjustable over the entire frequency range; can be set to sweep either up or down in frequency.
End-Point Accuracy: Refer to RF Unit specifications, same as frequency accuracy.

DESCRIPTION: Marker Sweep end-point accuracy is checked in MARKER SWEEP using Manual mode.

PERFORMANCE TESTS

4-8. MARKER SWEEP TEST (Cont'd)

EQUIPMENT: Refer to RF Unit Frequency Range and Accuracy performance test.

PROCEDURE: In MARKER SWEEP, Manual mode, check low end and high end of band for end-point accuracy according to RF Unit performance test for manual sweep accuracy; Frequency Range and Accuracy Test.

4-9. CW OPERATION TEST

SPECIFICATION: **CW Operation:** Single-frequency RF output. Adjusted with CW MARKER control and activated by pressing CW pushbutton.

Accuracy: Refer to RF Unit specifications, same as frequency accuracy.

DESCRIPTION: CW Frequency accuracy is checked in CW mode.

EQUIPMENT: Refer to RF Unit Frequency Range and Accuracy performance test.

PROCEDURE: In CW, check CW Frequency accuracy at low end, center, and high end of band according to RF Unit performance test for CW mode accuracy; Frequency Range and Accuracy Test.

4-10. CW VERNIER TEST

SPECIFICATION: **CW Vernier:** Calibrated directly in MHz about CW setting. CW Vernier activated by pressing pushbutton in CW VERNIER frequency control. Zero to $\pm 0.5\%$ or $\pm 5\%$ of full bandwidth, selectable with front-panel switch.

Accuracy: Refer to RF Unit specifications, same as frequency accuracy.

DESCRIPTION: CW Vernier accuracy is checked at left-edge, then right-edge of scale in both X1 and X.1 multiplier positions with CW frequency control at center-scale mark.

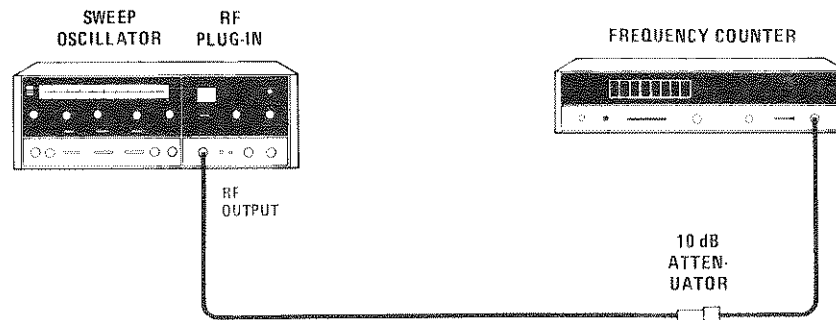

Figure 4-1. CW Vernier Test Setup

EQUIPMENT: Sweep Oscillator HP 8620C
 Frequency Counter HP 5340A
 10 dB Attenuator HP 8491B, Option 010

PERFORMANCE TESTS

4-10. CW VERNIER TEST (Cont'd)

- PROCEDURE:
- a. Connect equipment as shown in Figure 4-1.
 - b. Press CW and CW VERNIER pushbuttons.
 - c. Set CW frequency control to center-scale mark and CW VERNIER Multiplier to X1. Set CW VERNIER pointer to center-scale mark. Record frequency counter indication for use later.
 - d. Set CW VERNIER pointer to left-edge scale mark. Frequency indication should be lower than that recorded in step a by $5\% \pm 0.3\%$ of full frequency bandwidth.
 - e. Set CW VERNIER pointer to right-edge scale mark. Frequency indication should be higher than that recorded in step a by $5\% \pm 0.3\%$ of full frequency bandwidth.
 - f. Set CW VERNIER Multiplier to X.1. Set CW VERNIER pointer to center-scale mark and record frequency indication for use later.
 - g. Set CW VERNIER pointer to left-edge scale mark. Frequency should be lower than that recorded in step d by $0.5\% \pm 0.05\%$ of full frequency range.
 - h. Set CW VERNIER pointer to right-edge scale mark. Frequency should be higher than that recorded in step d by $0.5\% \pm 0.05\%$ of full frequency range.

4-11. ΔF SWEEP TEST

SPECIFICATION: ΔF Sweep: Sweeps upward in frequency, centered on CW setting. CW Vernier can be activated for fine control of center frequency.

Width: Continuously adjustable and calibrated from zero to 1%, zero to 10%, or zero to 100% of usable frequency band as selected with front panel slide switch. Scale calibrated directly in MHz.

Width Accuracy: $\pm 1\%$ of maximum ΔF plus $\pm 2\%$ of ΔF being swept.

Center Frequency Accuracy: Refer to RF Unit specifications, same as frequency accuracy.

DESCRIPTION: Accuracy of ΔF Sweep is checked, with maximum ΔF , in all multiplier positions by monitoring RF Output with frequency counter.

PERFORMANCE TESTS

4-11. ΔF SWEEP TEST (Cont'd)

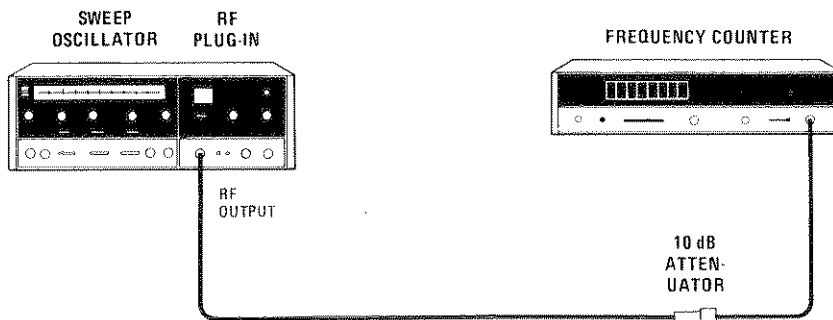

Figure 4-2. ΔF Sweep Test Setup

EQUIPMENT:

Sweep Oscillator	HP 8620C
Frequency Counter	HP 5340A
10 dB Attenuator	HP 8491B, Option 010

- PROCEDURE:
- Connect equipment as shown in Figure 4-2.
 - Set CW pointer to center-scale mark and adjust for center-scale frequency indication on frequency counter.

NOTE

Center-scale frequency can be determined by adding one-half of total bandwidth to the low-end frequency of the band.

Example:

86330B (1.8–4.2 GHz) RF Plug-in

Total bandwidth is range from 1.8 to 4.2 GHz or 2.4 GHz. Center-scale frequency, therefore, is 1.8 GHz + 1.2 GHz or 3.0 GHz for the 86330B.

- Press ΔF pushbutton. Set ΔF Multiplier to X10. Set ΔF pointer to right-edge scale mark.
- Set sweep MODE to MANUAL, and MANUAL control fully clockwise.
- Frequency counter should read high-end frequency of band $\pm 3\%$ of total bandwidth.

NOTE

The tolerance of $\pm 3\%$ used is determined using specifications of Table 1-1 in this manual: $\pm 1\%$ of maximum $\Delta F \pm 2\%$ of ΔF being swept. With ΔF Multiplier in the X10 position and ΔF pointer to right-edge scale mark, the total bandwidth is being swept. Therefore, the tolerance becomes $\pm 3\%$ of the total bandwidth.

Example:

86330B (1.8–4.2 GHz) RF Plug-in

PERFORMANCE TESTS

4-11. ΔF SWEEP TEST (Cont'd)**Example: (cont'd)**

Total bandwidth is 2.4 GHz. Therefore, tolerance is $\pm 3\%$ of 2.4 GHz of ± 72 MHz. Frequency indication, then, would be 4.2 GHz ± 72 MHz for the 86330B.

- f. Set MANUAL control fully counterclockwise. Frequency counter should read low-frequency end of band $\pm 3\%$ of total bandwidth.
- g. Set ΔF Multiplier to X1. Adjust CW and CW VERNIER controls for a convenient frequency counter indication. Record reading for use later.
- h. Set MANUAL control fully clockwise. Frequency counter indication should be higher than reading recorded in step g by $10\% \pm 0.3\%$ of total bandwidth.

NOTE

The tolerance of $\pm 0.3\%$ used is determined using specifications of Table 1-1 in this manual: $\pm 1\%$ of maximum $\Delta F \pm 2\%$ of ΔF being swept. With ΔF Multiplier in X1 position and ΔF pointer to right-edge scale mark, maximum ΔF and ΔF being swept are both 10% (0.1) of total bandwidth. Therefore, the tolerance becomes $\pm 3\%$ times the percent of band used (10%) or $\pm 0.3\%$ of total bandwidth.

Example:

86330B (1.8–4.2 GHz) RF Plug-in

Total bandwidth is 2.4 GHz. Therefore, 10% of total bandwidth is 0.24 GHz or 240 MHz. Tolerance is $\pm 0.3\%$ of total bandwidth or ± 7.2 MHz. Frequency indication, then, would be 240 MHz ± 7.2 MHz higher than reading recorded in step g for the 86330B.

- i. Set MANUAL control fully counterclockwise. Set ΔF Multiplier to X.1. Adjust CW and CW VERNIER controls for a convenient frequency indication. Record reading for use later.
- j. Set MANUAL control fully clockwise. Frequency counter indication should be higher than reading recorded in step i by $1.0\% \pm 0.03\%$ of total bandwidth.

NOTE

The tolerance of $\pm 0.03\%$ used is determined using specifications of Table 1-1 in this manual: $\pm 1\%$ of maximum $\Delta F \pm 2\%$ of ΔF being swept. With ΔF Multiplier in X.1 position and ΔF pointer to right-edge scale mark, maximum ΔF and ΔF being swept are both 1.0% (0.01) of total bandwidth. Therefore, the tolerance becomes $\pm 3\%$ times the percent of band used (1.0%) or $\pm 0.03\%$ of total bandwidth.

Example:

86330B (1.8–4.2 GHz) RF Plug-in

PERFORMANCE TESTS

4-11. ΔF SWEEP TEST (Cont'd)**Example (cont'd):**

Total bandwidth is 2.4 GHz. Therefore, 1.0% of total bandwidth is 0.024 GHz or 24 MHz. Tolerance is $\pm 0.03\%$ of total bandwidth or ± 0.72 MHz. Frequency indication would be 24 MHz ± 0.72 MHz higher than reading recorded in step i for the 86330B.

4-12. SWEEP TIME ADJUST AND STOP SWEEP TEST (HP Model 86290A ONLY)

SPECIFICATION: **Sweep Time Adjust:** Input to 8620C sweep circuits provided by wideband RF Plug-in to reduce the sweep time when sweeping full range.

Stop Sweep Pulse: Input to 8620C sweep circuits provided by wideband RF Plug-in to stop the sweep during the time RF Plug-in is changing bands to ensure full-range uninterrupted sweep.

DESCRIPTION: Sequential sweep ramp is displayed on oscilloscope and sweep time interval relationships are verified. Timing of stop sweep pulse is verified by time comparison of negative blanking output and sequential sweep ramp.

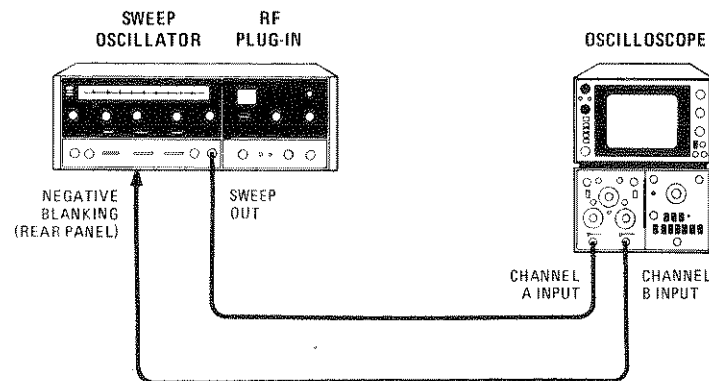

Figure 4-3. Sweep Time Adjust and Stop Sweep Test Setup

EQUIPMENT: Sweep Oscillator HP 8620C
Oscilloscope; Variable Persistence HP 181A/1801A/1820C

- PROCEDURE:**
- a. Connect equipment as shown in Figure 4-3.
 - b. Set DISPLAY BLANKING/OFF switch on 8620C rear panel to DISPLAY BLANKING.
 - c. Set TIME-SECONDS switch to .1—.01 and TIME-SECONDS Vernier control fully clockwise. Select Band 4.
 - d. Press FULL SWEEP pushbutton.
 - e. Adjust oscilloscope Channel A and Channel B to display waveform as shown in Figure 4-4.

PERFORMANCE TESTS

4-12. SWEEP TIME ADJUST AND STOP SWEEP TEST (HP Model 8629A ONLY) (Cont'd)

- f. Time (a) should be shorter than both times (c) and (e). Time (c) should be longer than both Times (a) and (e). Time (e) should be longer than Time (a) but shorter than Time (c).
- g. Time (d) should be longer than Time (b).
- h. Relationship of sequential sweep ramp (Channel A) and Negative Blanking waveform (Channel E) should be as shown in Figure 4-4.

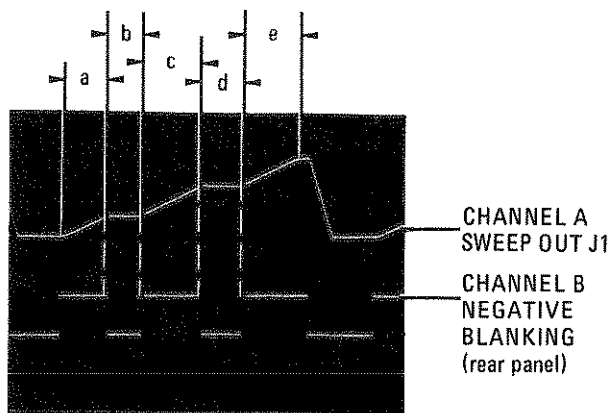

Figure 4-4. Sequential Sweep Ramp Compared in Time to Negative Blanking

4-13. AMPLITUDE MODULATION TEST

SPECIFICATION: Internal AM: Square-wave modulation on all sweep times (internally adjusted from 950 to 1050 Hz).

ON/OFF Ratio: Refer to RF Unit specifications.

DESCRIPTION: Internal 1 kHz modulation is selected and modulated RF output is monitored on frequency counter.

PERFORMANCE TESTS

4-13. AMPLITUDE MODULATION TEST (Cont'd)

Figure 4-5. Amplitude Modulation Test Setup

EQUIPMENT:	Sweep Oscillator	HP 8620C
	APC-7 to N Male Adapter	HP 1250-0479
	Crystal Detector	HP 423A or HP 8470A as required
	10 dB Attenuator	HP 8491B, Option 010
	Frequency Counter	HP 5340A

- PROCEDURE:**
- a. Set **POWER LEVEL** control on RF Plug-in front panel fully counterclockwise.
 - b. Connect equipment as shown in Figure 4-5.
 - c. Set 1kHz SQ WV/OFF switch on 8620C rear panel to 1kHz SQ WV.
 - d. Press CW pushbutton.
 - e. Set frequency counter to read 1 kHz and rotate **POWER LEVEL** control clockwise until frequency counter indicates a frequency.

CAUTION

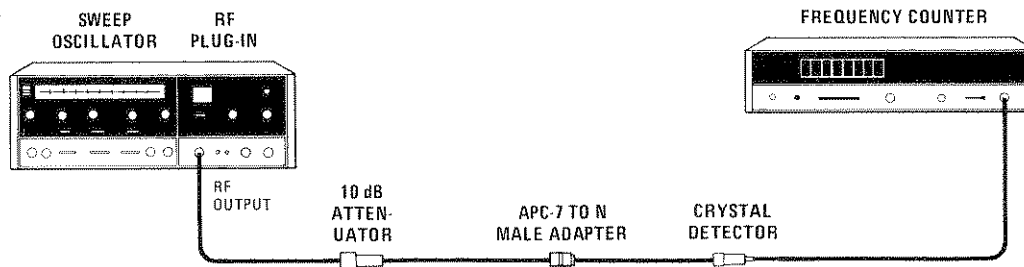
Care must be taken not to exceed the maximum power input limit of frequency counter.

- f. Frequency counter indication should be 1.0 kHz \pm 0.05 kHz.

4-14. BLANKING OUTPUTS TEST

SPECIFICATION: Blanking: With RF **BLANKING/OFF** switch set to RF **BLANKING**, RF is automatically turned off during retrace and turned on after completion of retrace. On automatic sweeps, RF is on long enough before sweep starts to stabilize external circuits and equipment whose response is compatible with the selected sweep rate.

Blanking Outputs: Rectangular pulse approximately +5V into 2500 ohms (coincident with RF blanking), available from rear-panel Z-AXIS/MKR/PEN LIFT output jack. A negative rectangular pulse +5V into 2500 ohms is available from rear-panel **NEGATIVE BLANKING** output jack.

PERFORMANCE TESTS

4-14. BLANKING OUTPUTS TEST (Cont'd)

DESCRIPTION: Display Blanking and RF Blanking are checked by monitoring detected RF output on oscilloscope with either Display Blanking or RF Blanking. Negative Blanking and Positive Blanking are checked by time comparison of blanking waveform and sweep ramp.

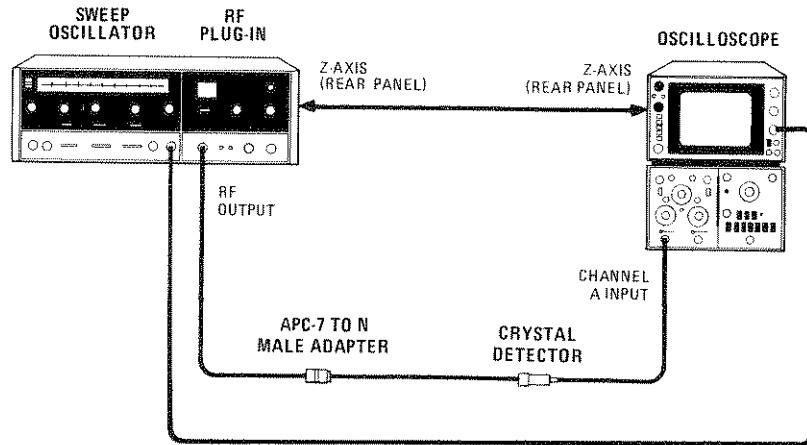

Figure 4-6. Display Blanking and RF Blanking Test Setup

EQUIPMENT: Sweep Oscillator HP 8620C
 APC-7 to N Male Adapter HP 1250-0479
 Crystal Detector HP 423A or HP 8470A as required
 Oscilloscope; Variable Persistence . . . HP 181A/1801A/1820C

- PROCEDURE: *Display Blanking and RF Blanking:*
- a. Set RF Plug-in POWER LEVEL control fully counterclockwise.
 - b. Connect equipment as shown in Figure 4-6.
 - c. Set TIME-SECONDS switch to .1-.01 and TIME-SECONDS Vernier control fully clockwise.
 - d. Press FULL SWEEP pushbutton.
 - e. Set DISPLAY BLANKING/OFF switch on 8620C rear panel to OFF. Set RF BLANKING/OFF switch on 8620C rear panel to OFF.
 - f. Adjust oscilloscope and RF Plug-in POWER LEVEL control for display similar to typical display shown in Figure 4-7.
 - g. Set 8620C rear-panel RF BLANKING/OFF switch to RF BLANKING.
 - h. Oscilloscope display should be similar to typical display shown in Figure 4-8.
 - i. Set 8620C rear-panel DISPLAY BLANKING/OFF switch to DISPLAY BLANKING.
 - j. Oscilloscope display should be similar to typical display shown in Figure 4-9.

PERFORMANCE TESTS

4-14. BLANKING OUTPUTS TEST (Cont'd)

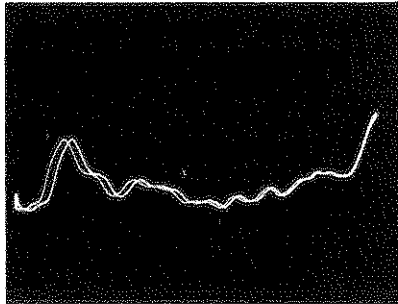

Figure 4-7. Typical Display with No Blanking

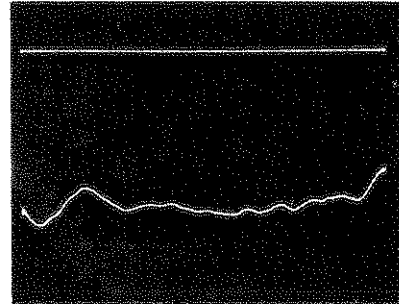

Figure 4-8. Typical Display with RF Blanking

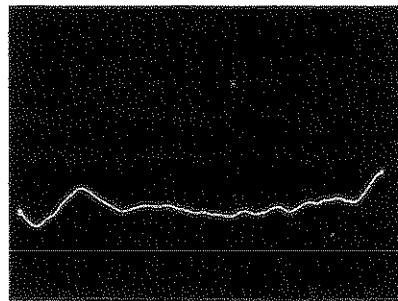

Figure 4-9. Typical Display with Display Blanking

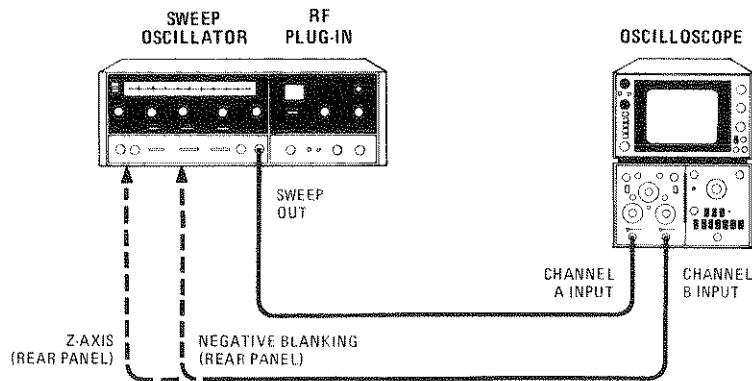

Figure 4-10. Negative and Positive Blanking Test Setup

EQUIPMENT: Sweep Oscillator HP 8620C
 Oscilloscope; Variable Persistence HP 181A/1801A/1820C

Negative and Positive Blanking

- k. Connect equipment as shown in Figure 4-10. Verify oscilloscope Channel B connected to NEGATIVE BLANKING on 8620C rear panel.

PERFORMANCE TESTS

4-14. BLANKING OUTPUTS TEST (Cont'd)

- l. Set 8620C rear-panel DISPLAY BLANKING/OFF switch to DISPLAY BLANKING.
- m. Press FULL SWEEP pushbutton.
- n. Adjust oscilloscope to display waveforms as shown in Figure 4-11.
- o. Connect oscilloscope Channel B to 8620C rear-panel Z-AXIS/MKR/PEN LIFT connector.
- p. Adjust oscilloscope to display waveforms as shown in Figure 4-12.

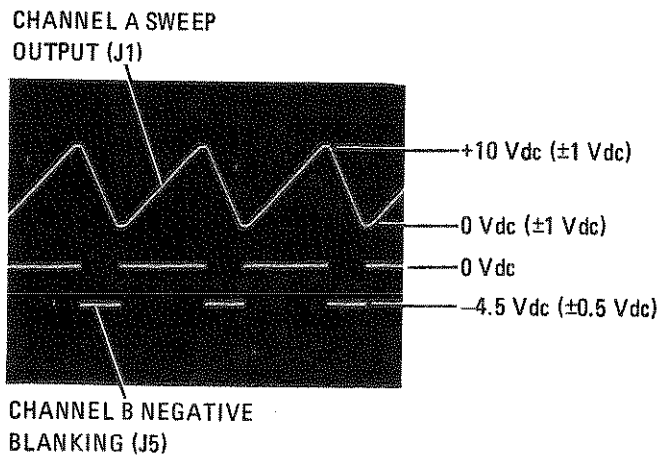

Figure 4-11. Negative Blanking at J5 Compared in Time to Sweep Output at J1

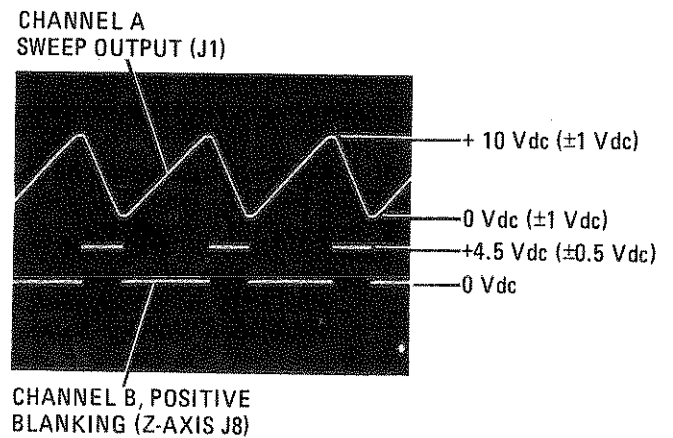

Figure 4-12. Positive Blanking at J8 Compared in Time to Sweep Output at J1

4-15. TRIGGERED SWEEP TEST

SPECIFICATION: **Triggered Sweep:** Sweep is actuated by front panel slide switch, or by externally applied signal $\geq +2$ volts peak, $>0.5 \mu s$ pulse width, and <1.0 MHz repetition rate. (Signal applied to rear-panel EXT TRIGGER input.)

DESCRIPTION: START MARKER AND STOP MARKER pointers are set to the two end points and band is swept with MANUAL control. The sweep is then triggered with SINGLE sweep TRIGGER switch on front panel. In EXT position of the TRIGGER switch, an external voltage is applied to the rear panel and a single sweep is triggered each time a voltage is applied.

PERFORMANCE TESTS

4-15. TRIGGERED SWEEP TEST (Cont'd)

Figure 4-13. Triggered Sweep Test Setup

EQUIPMENT:

Pulse Generator	HP 8002A
Sweep Oscillator	HP 8620C
Oscilloscope; Variable Persistence	HP 181A/1801A/1820C

- PROCEDURE:**
- Connect equipment as shown in Figure 4-13.
 - Press FULL SWEEP pushbutton.
 - Set sweep MODE switch to AUTO, TIME-SECONDS switch to .1—.01, and TIME-SECONDS Vernier fully clockwise.
 - Set TRIGGER switch to EXT. Adjust pulse generator for 2 volt positive pulse, pulse width of 0.5 μ s, and repetition rate of 1 MHz.
 - Oscilloscope should display a continuous recurring trace.
 - Disconnect EXT TRIGGER. Set TIME-SECONDS to 10—1.
 - Set TRIGGER switch to SINGLE momentarily, then release. A single sweep should occur.

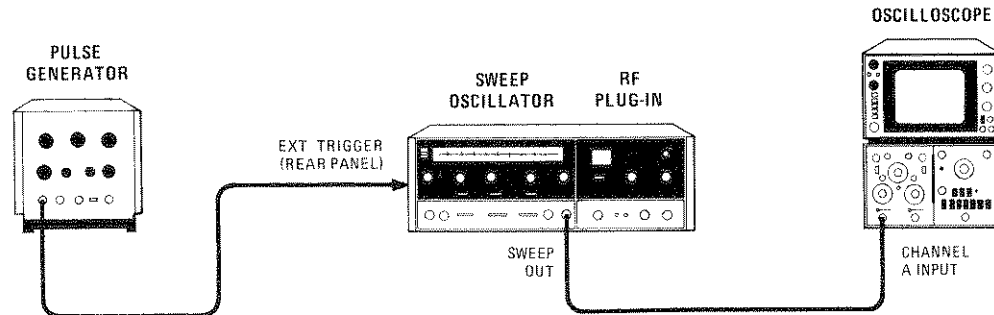
4-16. FREQUENCY MARKERS TEST

SPECIFICATION: Frequency Markers: Three constant-width frequency markers are fully calibrated and independently adjustable over the entire range in FULL SWEEP; the markers are controlled by the START MARKER, STOP MARKER, and CW MARKER controls. In Δ F Sweep, Start and Stop Markers are available; in MARKER SWEEP, the CW Marker is available. Front panel switch provides for the selection of either amplitude or intensity markers (amplitude modulating the RF output or Z-axis modulating the CRT display).

DESCRIPTION: Frequency markers are checked by displaying detected RF output on oscilloscope; first with amplitude markers, then intensity markers.

PERFORMANCE TESTS

4-16. FREQUENCY MARKERS TEST (Cont'd)

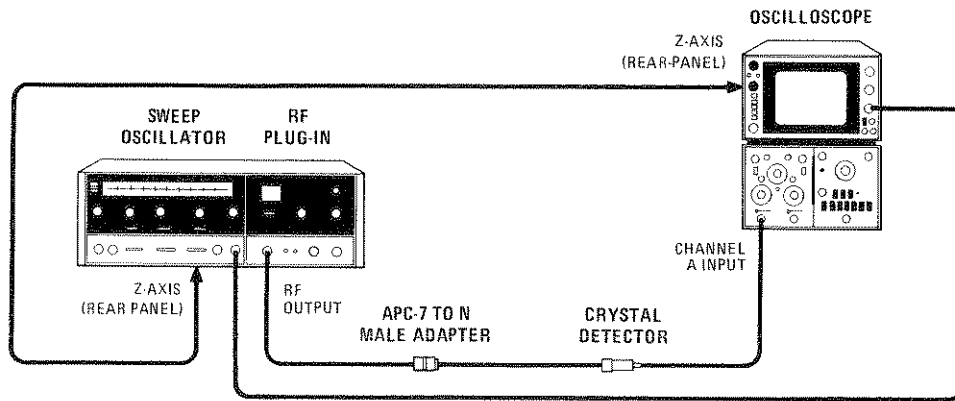

Figure 4-14. Frequency Markers Test Setup

EQUIPMENT:	Sweep Oscillator	HP 8620C
	APC-7 to N Male Adapter	HP 1250-0479
	Crystal Detector	HP 8470A
	Oscilloscope; Variable Persistence	HP 181A/1801A/1820C

- PROCEDURE:
- a. Set RF Plug-in POWER LEVEL control fully counterclockwise.
 - b. Connect equipment as shown in Figure 4-14.
 - c. Set TIME-SECONDS switch to .1—.01 and TIME-SECONDS Vernier fully clockwise.
 - d. Set 8620C rear-panel DISPLAY BLANKING/OFF switch to DISPLAY BLANKING. Set 8620C rear-panel RF BLANKING/OFF switch to RF BLANKING.
 - e. Set Start Marker (green pointer) to one-quarter scale, CW Marker (white pointer) to half-scale, and Stop Marker (red pointer) to three-quarter scale.
 - f. Set 8620C front-panel MARKERS switch to AMPL.
 - g. Press FULL SWEEP pushbutton.
 - h. Adjust RF Plug-in POWER LEVEL control and oscilloscope controls for display similar to typical display shown in Figure 4-15.
 - i. Set 8620C front-panel MARKERS switch to INTEN.
 - j. Oscilloscope display should be similar to typical display shown in Figure 4-16.

PERFORMANCE TESTS

4-16. FREQUENCY MARKERS TEST (Cont'd)

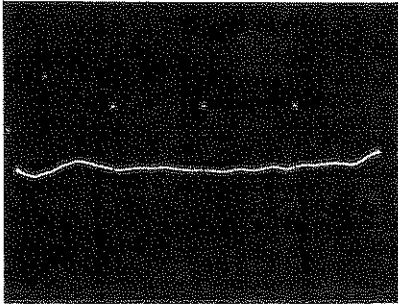

Figure 4-15. Typical Display with Amplitude Markers

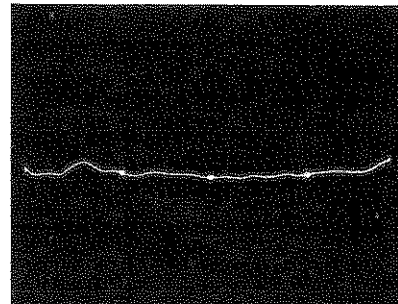

Figure 4-16. Typical Display with Intensity Markers

4-17. DIGITAL-TO-ANALOG CONVERTER TEST (OPTION 001)

SPECIFICATION: **Digital-to-Analog Converter:** In the Programmed Mode of operation, the D/A Converter uses digital intelligence inputs to develop analog tuning voltages for frequency tuning with resolution of 10,000 points across full band.

DESCRIPTION: Proper operation of the D/A Converter is verified by checking end-points (0 volt and +10 volt tuning voltages), then checking one-quarter scale, half-scale, and three-quarters scale frequency indications using digital inputs.

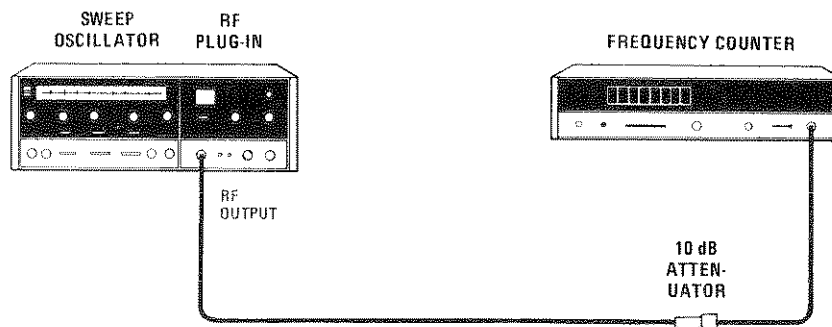

Figure 4-17. Digital-to-Analog Converter Test Setup

EQUIPMENT:

Sweep Oscillator	HP 8620C
Frequency Counter	HP 5340A
10 dB Attenuator	HP 8491B, Option 010
50-pin Service Board	HP 08620-60125

PROCEDURE:

- a. Set RF Plug-in POWER LEVEL control fully counterclockwise.
- b. Connect equipment as shown in Figure 4-17.

PERFORMANCE TESTS

4-17. DIGITAL-TO-ANALOG CONVERTER TEST (OPTION 001)

- c. Install 50-pin service board (HP Part No. 08620-60125) on 8620C rear-panel PROGRAMMING connector.
- d. Set remote D/A enable switch (R D/A) to GND. Set all BCD switches (8V, 4V, 2V, 1V, etc.) to GND.
- e. Press FULL pushbutton.
- f. Adjust RF Plug-in POWER LEVEL control until frequency counter indicates a frequency.

CAUTION

Care must be taken not to exceed the maximum power input limit of frequency counter or damage to the counter may occur.

- g. Frequency counter should read low-end frequency of band being tested. Refer to RF Unit specifications for CW mode frequency accuracy.
- h. Set 8V and 2V BCD switches to OPEN.
- i. Frequency counter should read high-end frequency of band. Refer to RF Unit specifications for CW mode frequency accuracy.
- j. Set BCD switches to OPEN in order indicated in Table 4-1. For each step in the table, refer to RF Unit specifications for CW mode frequency accuracy.

Table 4-1. BCD Inputs and Corresponding Frequency Outputs

BCD Switches (OPEN)	Tuning Voltage	Frequency
1. 2V, .4V, .08V, .01V .008V, .002V	2.5 Vdc	Determined by RF Plug-in CW mode frequency accuracy specifications.
2. 4V, 1V	5.0 Vdc	
3. 4V, 2V, 1V, .08V, .01V, .008V, .002V	7.5 Vdc	

4-18. MODEL 8620C PERFORMANCE TEST USING HP-IB, OPTION 001

DESCRIPTION: This Performance Test uses an HP Model 9830A/B Calculator and HP-IB compatible test instruments to test many of the specifications of the HP Model 8620C and HP Model 86200 series RF Plug-ins.

PERFORMANCE TESTS

4-18. MODEL 8620C PERFORMANCE TEST USING HP-IB, OPTION 001 (Cont'd)

NOTE

For proper operation of this program, the following address codes must be used for the test equipment. (Refer to the individual Operating and Service manuals for location of address switches.)

436A	Listen Address	"_"	3490A	Listen Address	"6"
436A	Talk Address	"M"	3490A	Talk Address	"V"
5340A	Listen Address	"*"	8620C	Listen Address	"&"
5340A	Talk Address	"J"			

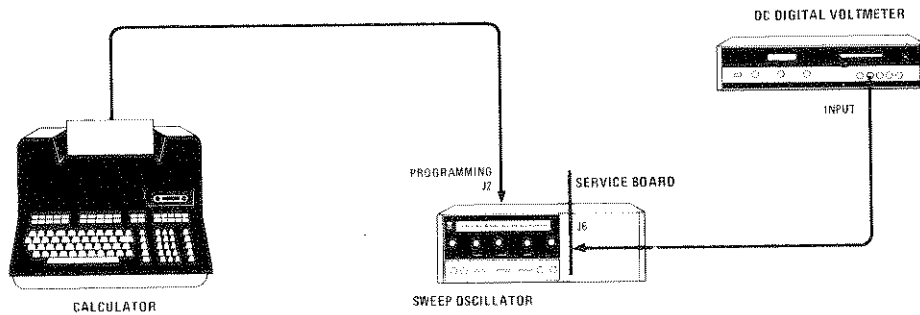

Figure 4-18. HP-IB Performance Test Setup for FILE 2

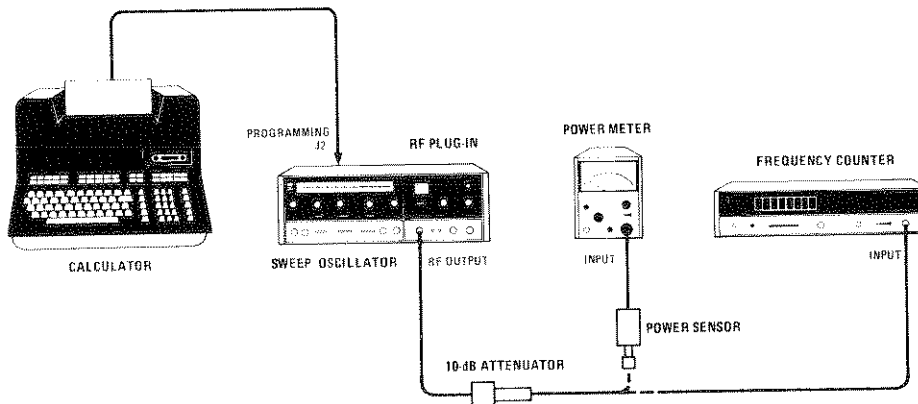

Figure 4-19. HP-IB Performance Test Setup for FILE 4

PERFORMANCE TESTS

4-18. MODEL 8620C PERFORMANCE TEST USING HP-IB, OPTION 001 (Cont'd)

EQUIPMENT: Sweep Oscillator HP 8620C
 Frequency Counter HP 5340A, Option 011
 DC Digital Voltmeter HP 3490A, Option 030
 Power Meter HP 436A, Option 022
 Power Sensor HP 8481A

PROCEDURE: 1. Cassette Program Loading Instructions

a. Insert a blank cassette tape into the 9830A/B calculator and mark take as follows:

- A. MARK (1)(2)(0)(0)(0) (FILE 0)
- B. MARK (1)(1)(0) (FILE 1)
- C. MARK (1)(4)(5)(0)(0) (FILE 2)
- D. MARK (1)(1)(0) (FILE 3)
- E. MARK (1)(2)(3)(5)(0) (FILE 4)
- F. MARK (1)(1)(0) (FILE 5)

NOTE
 For proper operation of the program, there must be a 10 "word" dummy file between each program file.

NOTE

If unfamiliar with HP Model 9830A/B Calculator operation, refer to 9830A Calculator Operating and Programming Manual, HP Part Number 09830-90001, for complete instructions for use of the calculator and its tape deck.

b. Rewind tape completely.













c. Enter first program listing (FILE 0) into the calculator.

d. Press [STOP] (0) $\left(\begin{array}{c} \text{[1]} \\ \text{[2]} \\ \text{[0]} \\ \text{[0]} \\ \text{[0]} \end{array} \right)$

e. Press [SEARCH] (A) $\left(\begin{array}{c} \text{[1]} \\ \text{[4]} \\ \text{[5]} \\ \text{[0]} \\ \text{[0]} \end{array} \right)$, then enter second (FILE 2) program and
 press [STOP] . Press [SEARCH] (A) $\left(\begin{array}{c} \text{[1]} \\ \text{[1]} \\ \text{[0]} \end{array} \right)$, then enter
 third (FILE 4) program.

PERFORMANCE TESTS

4-18. MODEL 8620C PERFORMANCE TEST USING HP-IB, OPTION 001 (Cont'd)

- f. Rewind tape and press  .
- g. When lazy T () appears on the calculator display, the program.
- h. Repeat step g for *FILE 2* and *FILE 4*.
- i. Press   then press  . The calculator will respond by printing ENTER MODEL NUMBER.
- j. Enter the exact model number, including suffix letters, of the 8620C or RF Plug-In to be tested. (Do not add any spaces or other characters, for example       .)
- k. The calculator will immediately go to the proper file for the model number indicated and begin execution of the program. Read the calculator instructions carefully and do as the calculator instructs.

FILE 0 (1 of 5)

```
30 DIM M$(6),F(4),H(4),A$(10),B$(30),C(4),DS(5,50)
35 DIM ES(5,50),D$(30),WS(100),GS(55),V(4),I(4),B(5,50),AS(5,50)
40 P=1
45 REWIND
50 PRINT "ENTER MODEL NUMBER",LIN3
60 INPUT M$
70 IF LEN(M$)>5 THEN 120
80 IF M$(1,5)#"8620C" THEN 100
90 LOAD 2,10,30
100 PRINT "MODEL NUMBER AND POSITION NUMBER OF PLUG-IN MODULE ";
105 PRINT "TO BE CHECKED"LIN3
110 INPUT M$,P
120 IF M$(3,3)="3" THEN 1270
130 A=0
140 IF M$(4,4)<="4" THEN 170
150 A=2
160 GOTO 200
170 IF M$(5,5)>"0" THEN 200
180 B=VAL(M$(4,4))+A
190 GOTO 210
200 B=VAL(M$(4,4))+VAL(M$(5,5))+A
210 IF B<9 THEN 230
220 B=9
230 GOTO B OF 240,340,540,440,720,820,920,1020,1120
240 REM 86210A SPECS
250 F(1)=1E+07
260 H(1)=3.5E+08
270 E1=7E+06
280 E2=7E+06
290 B1=1
300 CMD "?U&","V0286E"
310 V1=286
320 V2=9999
330 LINK 4,10
340 REM 86220A
350 F(1)=1E+07
360 H(1)=1.3E+09
370 E1=1E+07
380 E2=E1
390 B1=1
400 CMD "?U&","V0077"
410 V1=76.92
420 V2=9999
430 LINK 4,10
440 REM 86222A/B
450 F(1)=1E+07
460 H(1)=2.4E+09
470 E1=1E+07
480 E2=E1
490 B1=1
500 CMD "?U&","V0E"
```

FILE 0 (2 of 5)

```
510 V1=0
520 V2=9999
530 LINK 4,10
540 REM 86230A/B
550 E1=1E+07
560 E2=E1
570 IF M$(6,6)="B" THEN 650
580 F[1]=2E+09
590 H[1]=4E+09
600 B1=1
610 CMD "?U&","VOE"
620 V1=0
630 V2=9999
640 LINK 4,10
650 F[1]=1.8E+09
660 H[1]=4.2E+09
670 B1=1
680 CMD "?U&","VOE"
690 V1=0
700 V2=9999
710 LINK 4,10
720 REM 86241A
730 F[1]=3.2E+09
740 H[1]=6.5E+09
750 E1=3E+07
760 E2=E1
770 B1=1
780 CMD "?U&","V0286E"
790 V1=286
800 V2=9714
810 LINK 4,10
820 REM 86242A/C
830 F[1]=5.9E+09
840 H[1]=9E+09
850 E1=3.5E+07
860 E2=E1
870 B1=1
880 CMD "?U&","VOE"
890 V1=0
900 V2=9999
910 LINK 4,10
920 REM 86250A/B/C
930 F[1]=8E+09
940 H[1]=1.24E+10
950 E1=4E+07
960 E2=E1
970 B1=1
980 CMD "?U&","VOE"
990 V1=0
1000 V2=9999
```

FILE 0 (3 of 5)

```
1010 LINK 4,10
1020 REM 86260A
1030 F[1]=1.24E+10
1040 H[1]=1.8E+10
1050 E1=5E+07
1060 E2=E1
1070 B1=1
1080 CMD "?U&","V0667E"
1090 V1=667
1100 V2=9999
1110 LINK 4,10
1120 REM 86290A
1130 F[1]=2E+09
1140 F[2]=6E+09
1150 F[3]=1.2E+10
1160 F[4]=F[1]
1170 H[1]=6.2E+09
1180 H[2]=1.24E+10
1190 H[3]=H[4]=1.8E+10
1200 E1=3E+07
1210 E2=8E+07
1220 B1=4
1230 CMD "?U&","V0E"
1240 V1=0
1250 V2=9999
1260 LINK 4,10
1270 A=0
1280 IF M$[4,4]<="4" THEN 1310
1290 A=2
1300 GOTO 1340
1310 IF M$[5,5]>"0" THEN 1340
1320 B=VAL(M$[4,4])-1
1330 GOTO 1350
1340 B=VAL(M$[4,4])+(VAL(M$[5,5])-1)+A
1350 GOTO B OF 1360,1470,1600,1730,1860,1990,2120,2250
1360 REM 86320A/B/C
1370 F[1]=1E+08
1380 H[1]=2E+09
1390 E1=1.5E+07
1400 E2=E1
1410 B1=1
1420 P=1
1430 CMD "?U&","V0500E"
1440 V1=500
1450 V2=9999
1460 LINK 4,10
1470 REM 86330A/B/C
1480 IF P>1 THEN 1510
1490 PRINT "IS "M$" IN POSITION 2 OR 3 OF 8621 RF DRAWER"LIN3
1500 INPUT P
```

FILE 0 (4 of 5)

```
1510 F[P]=1.8E+09
1520 H[P]=4.2E+09
1530 E1=1.5E+07
1540 E2=E1
1550 B1=P
1560 CMD "?U&","VOE"
1570 V1=0
1580 V2=9999
1590 LINK 4,10
1600 REM 86331A/B/C
1610 IF P>1 THEN 1640
1620 PRINT "IS "M$" IN POSITION 2 OR 3 OF 8621 RF DRAWER"LIN3
1630 INPUT P
1640 F[P]=1.7E+09
1650 H[P]=4.3E+09
1660 E1=2E+07
1670 E2=E1
1680 B1=P
1690 CMD "?U&","VOE"
1700 V1=0
1710 V2=9999
1720 LINK 4,10
1730 REM 86341A/B/C
1740 IF P>1 THEN 1770
1750 PRINT "IS "M$" IN POSITION 2 OR 3 OF 8621 RF DRAWER",LIN3
1760 INPUT P
1770 F[P]=3.2E+09
1780 H[P]=6.5E+09
1790 E1=3E+07
1800 E2=E1
1810 B1=P
1820 CMD "?U&","V0286E"
1830 V1=286
1840 V2=9714
1850 LINK 4,10
1860 REM 86342A/C
1870 IF P>1 THEN 1900
1880 PRINT "IS "M$" IN POSITION 2 OR 3 OF 8621 RF DRAWER",LIN3
1890 INPUT P
1900 F[P]=5.9E+09
1910 H[P]=9E+09
1920 E1=3.5E+07
1930 E2=E1
1940 B1=P
1950 CMD "?U&","VOE"
1960 V1=0
1970 V2=9999
1980 LINK 4,10
1990 REM 86350A/C
2000 IF P>1 THEN 2030
```

FILE 0 (5 of 5)

```
2010 PRINT "IS "M$" IN POSITION 2 OR 3 OF 8621 RF DRAWER",LIN3
2020 INPUT P
2030 F[P]=8E+09
2040 H[P]=1.24E+10
2050 E1=4E+07
2060 E2=E1
2070 B1=P
2080 CMD "?U&","VOE"
2090 V1=0
2100 V2=9999
2110 LINK 4,10
2120 REM 86351A
2130 IF P>1 THEN 2160
2140 PRINT "IS "M$" IN POSITION 2 OR 3 OF 8621 RF DRAWER",LIN3
2150 INPUT P
2160 F[P]=1.07E+10
2170 H[P]=1.17E+10
2180 E1=2E+07
2190 E2=E1
2200 B1=P
2210 CMD "?U&","VOE"
2220 V1=0
2230 V2=9999
2240 LINK 4,10
2250 REM 86352A
2260 IF P>1 THEN 2290
2270 PRINT "IS "M$" IN POSITION 2 OR 3 OF 8621 RF DRAWER"LIN3
2280 INPUT P
2290 F[P]=8.5E+09
2300 H[P]=1.05E+10
2310 E1=2E+07
2320 E2=E1
2330 B1=P
2340 CMD "?U&","VOE"
2350 V1=0
2360 V2=9999
2370 LINK 4,10
2380 END
```

FILE 2 (1 of 7)

```
10 REM ADDRESS---8620C=&----3490A=6 (LISTEN),V (TALK)-----
20 REM 8620C VERIFICATION AND ADJUSTMENT
30 DIM B$(30),C[22],C$(10),A[20]
40 PRINT "THIS PROGRAM IS USED TO CHECK THE 8620C(OPT.011";
45 PRINT "(HP-IB)),OR AN 8620C",LIN1
50 PRINT "WITH A12-08620-60118-INSTALLED FOR TESTING,WITH A ";
55 PRINT "3490A(OPT.30 (HP-IB)"LIN1
60 PRINT "DVM OR ANY DVM WITH +-0.004% D.C. ACCURACY ON 100 ";
70 PRINT "VOLT RANGE."LIN3
80 PRINT TAB16"ARE YOU USING A 3490A(OPTION 30)?",LIN3
90 B=1
100 INPUT C$
110 IF C$[1,1]#"Y" THEN 140
120 J=0
130 GOTO 150
140 J=1
150 PRINT TAB21"SET 8620C CONTROLS AS FOLLOWS:",LIN3
160 PRINT TAB21"START MARKER ***** 2 VOLT MARK",LIN1
170 PRINT TAB21"STOP MARKER ***** 8 VOLT MARK",LIN1
180 PRINT TAB21"CW POINTER ***** 5 VOLT MARK",LIN1
190 PRINT TAB21"DELTA F POINTER ***** 5 VOLT MARK",LIN1
200 PRINT TAB21"CW VERNIER ***** CENTERED",LIN1
210 PRINT TAB21"MODE ***** MANUAL",LIN1
220 PRINT TAB21"MANUAL CONTROL ***** MAX CCW",LIN1
230 PRINT TAB21"TRIGGER ***** INT",LIN1
240 PRINT TAB21"TIME ***** 10-1 SEC",LIN1
250 PRINT TAB21"TIME VERNIER ***** MAX CCW",LIN1
260 PRINT TAB21"DELTA F MULTIPLIER ***** X1",LIN1
270 PRINT TAB21"MARKERS ***** OFF",LIN1
280 PRINT TAB21"CWV MULTIPLIER ***** X1",LIN4
290 PRINT TAB15"INSTALL 8620 SERVICE BOARD PART NUMBER 08620-60037"
300 PRINT LIN(2)
310 PRINT "TO CONTINUE WITH PROGRAM PRESS--SPACE-EXECUTE",LIN3
320 INPUT B$
330 PRINT "SWITCH 8620C AND DVM ON AND ALLOW FOR A 30 MINUTE WARM UP"
340 PRINT LIN(3)
350 INPUT B$
360 PRINT "CONNECT VOLTMETER MINUS LEAD TO J6 PIN32 AND PLUS ";
370 PRINT "LEAD TO J6 PIN 34"LIN2
380 INPUT B$
390 PRINT TAB21"+20 VOLT CHECK"
400 PRINT LIN(2)
410 B=1
420 M=20
430 E=0.006
440 GOSUB 1560
450 PRINT TAB15"***** +20 VOLT SUPPLY CORRECT *****"
```

FILE 2 (2 of 7)

```
460 C[1]=V
470 PRINT LIN(2)
480 PRINT "CONNECT VOLTMETER MINUS LEAD TO J6 PIN32 AND PLUS ";
490 PRINT "LEAD TO J6 PIN 29"LIN2
500 INPUT B$
510 PRINT TAB21"-40 VOLT CHECK",LIN2
520 B=2
530 M=40
540 E=0.02
550 GOSUB 1560
560 PRINT TAB15"***** -40 VOLT SUPPLY CORRECT *****"
570 C[2]=V
580 PRINT LIN(2)
590 PRINT "CONNECT VOLTMETER MINUS LEAD TO J6 PIN32 AND PLUS ";
600 PRINT "LEAD TO J6 PIN 31"LIN2
610 INPUT B$
620 PRINT TAB21"-10 VOLT CHECK",LIN2
630 B=3
640 M=10
650 E=0.004
660 GOSUB 1560
670 PRINT TAB15"***** -10 VOLT SUPPLY CORRECT *****"
680 C[3]=V
690 PRINT LIN(2)
700 PRINT "CONNECT VOLTMETER MINUS LEAD TO J6 PIN32 AND PLUS ";
710 PRINT "LEAD TO J6 PIN 33"LIN2
720 INPUT B$
730 PRINT TAB21"+5 VOLT CHECK",LIN2
740 B=4
750 M=5
760 E=0.005
770 GOSUB 1560
780 PRINT TAB15"***** +5 VOLT SUPPLY CORRECT *****"
790 C[4]=V
800 PRINT LIN(2)
810 PRINT "CONNECT VOLTMETER MINUS LEAD TO J6 PIN32 AND PLUS ";
820 PRINT "LEAD TO J6 PIN 1"LIN2
830 INPUT B$
840 PRINT TAB21"FULL SWEEP CHECK",LIN2;
850 WAIT 1000
860 CMD "?U&","M1V0E"
870 B=5
880 M=0
890 E=0.005
900 DISP "LOW END"
910 GOSUB 1560
920 CMD "?U&","M1V:000E"
930 C[5]=V
940 B=5
950 M=10
```

FILE 2 (3 of 7)

```
960 E=0.005
970 DISP "HIGH END"
980 GOSUB 1560
990 PRINT TAB15"***** FULL SWEEP CORRECT *****"
1000 C[6]=V
1010 PRINT LIN(2)
1020 PRINT TAB21"MARKER SWEEP CHECK"
1030 PRINT LIN(2)
1040 WAIT 1000
1050 CMD "?U&","M4V0E"
1060 B=6
1070 M=2
1080 E=0.005
1090 DISP "LOW END"
1100 GOSUB 1560
1110 CMD "?U&","M4V:000E"
1120 C[7]=V
1130 B=6
1140 M=8
1150 E=0.005
1160 DISP "HIGH END"
1170 GOSUB 1560
1180 PRINT TAB15"***** MARKER SWEEP CORRECT *****"
1190 C[8]=V
1200 PRINT LIN(2)
1210 PRINT TAB21"CW CHECK"
1220 PRINT LIN(2)
1230 WAIT 1000
1240 CMD "?U&","M3"
1250 B=7
1260 M=5
1270 E=0.005
1280 DISP "MID BAND"
1290 GOSUB 1560
1300 PRINT TAB15"***** CW CORRECT *****"
1310 C[9]=V
1320 PRINT LIN(2)
1330 PRINT TAB21"DELTA F CHECK"
1340 PRINT LIN(2)
1350 WAIT 1000
1360 CMD "?U&","M2V0E"
1370 B=8
1380 M=4.5
1390 E=0.01
1400 DISP "LOW END"
1410 GOSUB 1560
1420 CMD "?U&","M2V:000E"
1430 C[10]=V
1440 B=8
1450 M=5.5
```

FILE 2 (4 of 7)

```
1460 E=0.01
1470 DISP "HIGH END"
1480 GOSUB 1560
1490 PRINT TAB15"***** DELTA F CORRECT *****"
1500 C[11]=V
1510 PRINT LIN(2)
1520 CMD "?U6"
1530 OUTPUT (13,1680)1024,768;
1540 GOTO 2680
1550 REM VOLTMETER MEASUREMENT & COMPARISON
1560 IF J THEN 1620
1570 CMD "?U6","M3R3F0TLE;"
1580 CMD "?V5"
1590 ENTER (13,1600)V
1600 FORMAT 4X,E12.0
1610 GOTO 1650
1620 PRINT TAB21"INPUT DVM READING"
1630 PRINT LIN(2)
1640 INPUT V
1650 A=ABS(ABS(V)-M)
1660 IF A<E THEN 1710
1670 CMD "?U6"
1680 FORMAT 2B
1690 OUTPUT (13,1680)1024,768;
1700 GOTO B OF 1720,1780,1830,1880,1930,2150,2340,2440
1710 RETURN
1720 REM ADJUSTMENT PROCEDURES
1730 REM +20 VOLT ADJUST
1740 PRINT SPA10"ADJUST +20 VOLT ADJUST A4R5 FOR +20VDC "LIN1
1750 PRINT SPA10"+ OR -0.006VDC ON DVM.",LIN3
1760 INPUT B$
1770 GOTO 410
1780 REM -40 VOLT ADJUST
1790 PRINT SPA10"ADJUST -40 VOLT ADJUST A5R9 FOR -40VDC"LIN1
1800 PRINT SPA10"+ OR -0.020VDC ON DVM.",LIN3
1810 INPUT B$
1820 GOTO 520
1830 REM -10 VOLT ADJUST
1840 PRINT SPA10"ADJUST -10 VOLT ADJUST A5R12 FOR -10VDC",LIN1
1850 PRINT SPA10"+ OR -0.004 VDC ON DVM.",LIN3
1860 INPUT B$
1870 GOTO 630
1880 REM +5 VOLT ADJUST
1890 PRINT SPA10"ADJUST +5 VOLT ADJUST A4R32 FOR +5VDC",LIN1
1900 PRINT SPA10"+ OR -0.005 VDC ON DVM."
1910 INPUT B$
1920 GOTO 740
1930 CMD "?U&"
1940 OUTPUT (13,1680)256,1,512
1950 FOR I=1 TO 2
```

FILE 2 (5 of 7)

```
1960 PRINT "TURN MANUAL CONTROL FULL CCW",LIN3
1970 INPUT B$
1980 PRINT SPA10"ADJUST A2R21 FOR 0.0VDC +-0.001VDC ON DVM.",LIN3
1990 INPUT B$
2000 PRINT "TURN MANUAL CONTROL FULL CW",LIN3
2010 INPUT B$
2020 PRINT SPA10"ADJUST A2R22 FOR 10VDC +-0.005VDC ON DVM.",LIN3
2030 INPUT B$
2040 NEXT I
2050 CMD "?U&","M1"
2060 FOR I=1 TO 2
2070 CMD " ","V0E"
2080 PRINT SPA10"ADJUST 'LO' A12R11 FOR 0.0VDC +-0.0005VDC ON DVM."
2085 PRINT LIN(3)
2090 INPUT B$
2100 CMD " ","V:000E"
2110 PRINT SPA10"ADJUST 'HI' A12R12 FOR +10VDC +-0.0005VDC ON DVM."
2115 PRINT LIN(3)
2120 INPUT B$
2130 NEXT I
2140 GOTO 860
2150 CMD "?U&","M4V0E"
2160 PRINT SPA10"SET 'STOP MARKER' TO 5 VOLT MARK ON SCALE",LIN1
2170 PRINT SPA10"SET 'START MARKER' TO 0 VOLT MARK ON SCALE",LIN2
2180 PRINT SPA10"ADJUST A2R55 FOR 0.0VDC +-0.001VDC ON DVM.",LIN3
2190 INPUT B$
2200 PRINT SPA10"SET 'START MARKER' TO 10 VOLT MARK ON SCALE",LIN1
2210 PRINT SPA10"ADJUST A2R26 FOR 10VDC +-0.005VDC ON DVM.",LIN3
2220 INPUT B$
2230 CMD " ","V:000E"
2240 PRINT SPA10"SET 'STOP MARKER' TO 0 VOLT MARK ON SCALE",LIN1
2250 PRINT SPA10"ADJUST A2R25 FOR 0.0VDC +-0.005VDC ON DVM.",LIN3
2260 INPUT B$
2270 PRINT SPA10"SET 'STOP MARKER' TO 10 VOLT MARK ON SCALE",LIN1
2280 PRINT SPA10"ADJUST A2R36 FOR 10VDC +-0.005VDC.",LIN3
2290 INPUT B$
2300 PRINT SPA10"SET 'STOP MARKER' TO 8 VOLT MARK",LIN1
2310 PRINT SPA10"SET 'START MARKER' TO 2 VOLT MARK",LIN3
2320 INPUT B$
2330 GOTO 1050
2340 CMD "?U&","M3"
2350 PRINT SPA10"SET 'CW MARKER' TO 0 VOLT MARK ON SCALE ",LIN1
2360 PRINT SPA10"ADJUST A2R50 FOR 0.0VDC +-0.001VDC ON DVM.",LIN3
2370 INPUT B$
2380 PRINT SPA10"SET 'CW MARKER' TO 10 VOLT MARK ON SCALE",LIN1
2390 PRINT SPA10"ADJUST A2R29 FOR 10VDC +-0.005VDC ON DVM.",LIN3
2400 INPUT B$
2410 PRINT SPA10"SET 'CW MARKER' TO 5 VOLT MARK",LIN3
2420 INPUT B$
2430 GOTO 1250
2440 CMD "?U&"
2450 OUTPUT (13,1680)256,1,512
```

FILE 2 (6 of 7)

```
2460 PRINT SPA10"PERFORM DELTA F ADJUSTMENT PROCEDURE IN MANUAL"LIN1
2470 PRINT SPA10"PAGE 5-13, PARAGRAPH 5-24",LIN3
2480 INPUT B$
2490 GOTO 1360
2500 REM BAND CHECK
2510 PRINT SPA10"REMOVE TEST BOARD AND INSTALL A 86290A RF",LIN1
2520 PRINT SPA10"PLUG-IN OR A 8621B WITH 86320,86330 OR 331,"LIN1
2525 PRINT SPA10"AND A 863XX RF PLUG-IN"LIN3
2530 INPUT B$
2540 PRINT TAB21"OBSERVE BANDS CHANGING ON RF PLUG-IN",LIN4
2550 WAIT 1000
2560 CMD "?U&","M1"
2570 DISP SPA6"BAND SWITCHING CHECK"
2580 FOR J=1 TO 2
2590 FOR I=1 TO 4
2600 OUTPUT (13,2610)I
2610 FORMAT "B",F1000.0
2620 WAIT 2000
2630 NEXT I
2640 NEXT J
2650 CMD " ","B1"
2660 PRINT SPA10"BAND SWITCHING CHECK COMPLETE",LIN2
2670 GOTO 2960
2680 REM TUNING VOLTAGE CHECK
2690 PRINT SPA6"TUNING VOLTAGE CHECK",LIN2
2700 WAIT 2000
2710 CMD "?U&","M1V0E"
2720 G=1
2730 FOR K=1.111 TO 10 STEP 1.111
2740 OUTPUT (13,2760)K
2750 IF J=1 THEN 2810
2760 FORMAT "V",F1000.3,"E"
2770 CMD "?U6","M3R3F0T1E"
2780 CMD "?V5"
2790 ENTER (13,1600)V
2800 GOTO 2830
2810 PRINT TAB21"INPUT DVM READING",LIN2
2820 INPUT V
2830 R=K
2840 A[G]=V
2850 G=G+1
2860 IF ABS(V-R) <= 0.002 THEN 2900
2870 OUTPUT (15,2880)
2880 FORMAT 37"*","ERROR",37"*"
2890 PRINT "DVM READING IS"V;"READING SHOULD BE "R;"ERROR IS "V-R,LIN3
2900 CMD "?U&"
2910 WAIT 1000
2920 NEXT K
2930 PRINT SPA10"VOLTAGE CHECK COMPLETE",LIN2
2940 WAIT 2000
2950 GOTO 2500
```

FILE 2 (7 of 7)

```
2960 PRINT SPA10"WHAT IS THE 8620C SERIAL NUMBER",LIN3
2970 INPUT C$
2980 PRINT SPA10"WHAT IS TODAY'S DATE",LIN3
2990 INPUT B$
3000 WRITE (15,3010)
3010 FORMAT 80"- "
3020 PRINT "DATE: "B$,LIN2
3030 PRINT SPA21"MODEL 8620C SWEEP OSCILLATOR MAINFRAME",LIN1
3040 PRINT SPA29"SERIAL NUMBER "C$,LIN3
3050 PRINT SPA35"TEST RECORD",LIN3
3060 PRINT SPA22"CHECK"SPA29"READING"
3070 PRINT SPA22"-----"SPA29"-----",LIN2
3080 PRINT SPA17"+20 VOLT SUPPLY"SPA26,C[1],LIN1
3090 PRINT SPA17"-40 VOLT SUPPLY"SPA26,C[2],LIN1
3100 PRINT SPA17"-10 VOLT SUPPLY"SPA26,C[3],LIN1
3110 PRINT SPA17"+5 VOLT SUPPLY"SPA27,C[4],LIN1
3120 PRINT SPA17"FULL SWEEP LOW END OF BAND"SPA15,C[5],LIN1
3130 PRINT SPA17"FULL SWEEP HIGH END OF BAND"SPA14,C[6],LIN1
3140 PRINT SPA17"MARKER SWEEP (START)"SPA21,C[7],LIN1
3150 PRINT SPA17"MARKER SWEEP (STOP)"SPA22,C[8],LIN1
3160 PRINT SPA17"CW MARKER"SPA32,C[9],LIN1
3170 PRINT SPA17"DELTA F (START)"SPA26,C[10],LIN1
3180 PRINT SPA17"DELTA F (STOP)"SPA27,C[11],LIN1
3190 PRINT SPA17"D/A VOLTAGES",LIN1
3200 FOR I=1 TO 9
3210 PRINT SPA58,A[I],LIN1
3220 NEXT I
3230 OUTPUT (15,3010)
3240 FORMAT 2B
3250 OUTPUT (13,3240)1024,768;
3260 PRINT SPA10"TEST COMPLETE"
3270 WAIT 1500
3280 PRINT "DO YOU WISH TO CHECK A 8620 RF PLUG-IN ?"LIN3
3290 INPUT C$
3300 IF C$[1,1]="N" THEN 3320
3310 LINK 0,10
3320 END
```

FILE 4 (1 of 4)

```

10 DIM D[5,50],F[4],H[4],B[5,50],B$[30],WS[100]
20 DIM A$[10],A[5,50],GS[55],D$[30],E[5,50],V[4],I[4],C[4]
30 REM FREQUENCY CHECK OF ALL 8620 PLUG-INS
35 REWIND
40 PRINT "THIS PROGRAM IS DESIGNED TO CHECK THE "M$" FREQUENCY ";
45 PRINT "AND POWER"LIN1
50 PRINT "ACCURACY USING HP-1B,8620C,5340A(COUNTER)AND 436A";
55 PRINT "(POWER METER)."LIN2
60 PRINT "CONNECT THE "M$" TO THE 436A AND SET THE "M$" POWER"LIN1
70 PRINT " CONTROL FOR MAXIMUM LEVELED POWER."LIN3
80 PRINT "TO CONTINUE WITH THIS PROGRAM AFTER EACH STOP PRES";
90 PRINT "S--SPACE BAR-EXECUTE."LIN1
100 INPUT B$
110 PRINT "DISCONNECT 436A AND CONNECT 5340A COUNTER TO ";
115 PRINT M$" OUTPUT"LIN3
120 INPUT B$
130 REM---ADDRESSES 8620C--"&"; 5340A--"*"(LISTEN), "j"(TALK)
140 REM---436A--"-"(LISTEN),"M"(TALK)
150 PRINT "WHAT FREQUENCY INCREMENT IN MHZ DO YOU WANT TO ME";
155 PRINT "ASURE ?"LIN3
160 INPUT I1
170 I1=I1*1E+06
180 FOR I=P TO B1
190 DISP "FREQUENCY CHECK"
200 CMD "?U&","M1"
210 OUTPUT (13,220)I,V1*0.001
220 FORMAT "L",F1000.0,"v",F8.3,"E"
225 WAIT 1000
230 C[I]=(H[I]-F[I])/I1
240 I[I]=(V2-V1)/C[I]*0.001
250 V[I]=I[I]+(V1*0.001)
260 C[I]=INT(C[I])
270 IF (C[I]+1)<50 THEN 310
280 PRINT "FREQUENCY INCREMENT IS TO SMALL CHOSE A LARGER ONE !",LIN3
290 WAIT 5000
300 GOTO 150
310 FOR N=1 TO C[I]+1
320 FORMAT 4X,F12.6
330 CMD "?U*","4PJ@MOH","?J5"
335 WAIT 1000
340 ENTER (13,350)D[I,N]
350 FORMAT 4X,E12.6
360 A[I,N]=ABS(D[I,N]-(F[I]+(N-1)*I1))
370 IF I<4 THEN 400
380 E=E2
390 GOTO 410
400 E=E1
410 B[I,N]=0
420 IF A[I,N]<E THEN 450
430 B[I,N]=1

```

FILE 4 (2 of 4)

```
440 E[I,N]=A[I,N]-E
450 WAIT 1500
460 IF V[I] <= (V2*0.001) THEN 480
470 V[I]=V2*0.001
480 CMD "?U&"
490 OUTPUT (13,500)V[I]
500 FORMAT "V",F10.3,"E"
510 V[I]=V[I]+I[I]
520 NEXT N
530 NEXT I
540 REM POWER CHECK
550 PRINT "DISCONNECT FREQUENCY COUNTER"LIN2
560 PRINT "ZERO AND CALIBRATE THE 436A & CONNECT IT TO THE "M$,LIN3
570 INPUT B$
580 CMD "?U&","M1"
590 OUTPUT (13,600)B1,V1*0.001
600 FORMAT "B",F1000.0,"V",F10.3,"E"
610 G[1]=V1*0.001
620 FOR J=1 TO 50
630 DISP "LEVELED POWER CHECK"
640 WAIT 300
650 K=J
660 CMD "?U-","DT"
670 CMD "?M5"
680 ENTER (13,690)W[J]
690 FORMAT 4X,E12.2
700 G[K+1]=G[K]+(V2-V1)*0.001/50
710 IF G[K+1] <= V2*0.001 THEN 730
720 G[K+1]=V2*0.001
730 CMD "?U&"
740 OUTPUT (13,500)G[K+1]
750 NEXT J
760 H=W[1]
770 L=W[1]
780 FOR J=2 TO 50
790 IF W[J] <= H THEN 810
800 H=W[J]
810 IF W[J] >= L THEN 830
820 L=W[J]
830 NEXT J
840 REM TEST RECORD OF FREQUENCY CHECK
850 PRINT "WHAT IS THE "M$" SERIAL NUMBER?",LIN1
860 INPUT A$
870 PRINT "WHAT IS THE 8620C SERIAL NUMBER?"LIN3
880 INPUT B$
890 PRINT "ENTER TODAY'S DATE",LIN3
900 INPUT D$
910 WRITE (15,920)
920 FORMAT 80"- "
930 PRINT "DATE: "D$,LIN2
```

FILE 4 (3 of 4)

```

940 PRINT SPA35"TEST RECORD"
950 PRINT SPA35"-----"LIN3
960 PRINT SPA22"MODEL "M$" SERIAL NUMBER ";A$
970 PRINT SPA22"-----"LIN2
980 PRINT SPA22"MODEL 8620C SERIAL NUMBER ";B$
990 PRINT SPA22"-----"LIN3
1000 PRINT "FREQUENCY"
1010 PRINT "-----"
1020 WRITE (15,1030)
1030 FORMAT 12X,"SET<GHZ>",17X,"MEASURED<GHZ>",12X,"DIFFERENCE<MHZ>"
1040 WRITE (15,1050)
1050 FORMAT 12X,68"- "
1060 PRINT
1070 REM FREQUENCY DATA PRINT OUT
1080 FOR I=P TO B1
1085 PRINT "BAND "I
1090 FOR J=1 TO C[I]+1
1100 WRITE (15,1110) (F[I]+((J-1)*I1))/1E+09,D[I,J]/1E+09,A[I,J]/1E+06
1110 FORMAT 4X,F12.3,15X,F12.3,15X,F12.3
1120 IF B[I,J]#1 THEN 1160
1130 WRITE (15,1140)E[I,J]
1140 FORMAT 9X,"↑↑↑↑ FREQUENCY ERROR ↑↑↑↑ ERROR =",F12.3,"MHZ"
1150 GOTO 1170
1160 PRINT
1170 NEXT J
1180 WRITE (15,920)
1190 NEXT I
1200 REM START OF MAXIMUM LEVELED POWER GRAPH
1210 PRINT LIN5
1220 WRITE (15,920)
1230 PRINT LIN5
1240 PRINT "FREQUENCY!"SPA25"POWER<DBM>"
1250 PRINT " <GHZ> !"
1260 R=F[B1]/1E+09
1270 Q=V1*0.001
1280 WRITE (15,1290)L,L+(H-L)/4,(H-L)/2+L,H-(H-L)/4,H,(H-L)/4+H
1290 FORMAT 9X,"!",6X,F5.2,5X,F5.2,5X,F5.2,5X,F5.2,5X,F5.2,5X,F5.2
1300 OUTPUT (15,1310)
1310 FORMAT "-----*",3"-----↑-----*", "-----"
1320 PRINT SPA9"!"SPA59"!"
1330 REM PLOTTING ROUTINE
1340 FOR I=1 TO 50
1350 IF G[I]#Q THEN 1400
1355 Z=INT(R)+(INT((R-INT(R))*10+0.5))*0.1
1360 PRINT Z;TAB9"+"TAB(( (W[I]-L)/(H-L)*40)+20) "*"TAB69"+"
1370 R=R+(H[B1]-F[B1])/8E+09
1380 Q=Q+0.006*(V2-V1)/50
1390 GOTO 1410
1400 PRINT SPA9"!"TAB(( (W[I]-L)/(H-L)*40)+20) "*"TAB69"!"
1410 NEXT I

```

FILE 4 (4 of 4)

```
1420 PRINT SPA9"! "TAB69"! "  
1430 OUTPUT (15,1310)  
1440 PRINT LIN(3)  
1450 PRINT "MAX POWER ="H;"MIN POWER ="L;"VARIATION ="H-L,LIN2  
1460 WRITE (15,920)  
1470 PRINT LIN5  
1480 FORMAT 2B  
1490 OUTPUT (13,1480)1024,768;  
1500 PRINT "DO YOU WISH TO CHECK ANOTHER PLUG-IN OR A 8620C?",LIN3  
1510 INPUT A$  
1520 IF A$[1,1]="N" THEN 1540  
1530 LINK 0,10  
1540 PRINT "DO YOU WISH TO CHECK ANOTHER "M$" ?",LIN3  
1550 INPUT A$  
1560 IF A$[1,1]="N" THEN 1580  
1570 GOTO 60  
1580 END
```

SECTION V ADJUSTMENTS

5-1. INTRODUCTION

5-2. This section provides adjustment procedures for the Model 8620C Sweep Oscillator mainframe. These procedures should not be performed as a routine maintenance procedure but should be used after replacement of a part or component or when the performance test shows that the specifications of Table 1-1 cannot be met. Table 5-1 lists the adjustment controls and their functions and also the paragraph number of the adjustment procedure for each.

5-3. EQUIPMENT REQUIRED

5-4. Table 1-4 lists the equipment required for the adjustment procedure. If the test equipment recommended is not available, other equipment may be used if its performance meets the "Critical Specifications" listed in the table.

5-5. SAFETY CONSIDERATIONS

5-6. Although this instrument has been designed in accordance with international safety standards, this manual contains information, cautions, and warnings which should be followed to ensure safe operation and to retain the instrument in safe condition (see Sections II and III). Service and adjustments should be performed only by qualified service personnel.

WARNING

Any interruption of the protective (grounding) conductor (inside or outside the instrument) or disconnecting the protective earth terminal could make this instrument dangerous.

5-7. Any adjustment, maintenance, or repair of the opened instrument under voltage should be

avoided as much as possible but, when necessary, should be performed only by skilled persons who are aware of the hazard involved.

5-8. Capacitors inside the instrument may still be charged even if the instrument has been disconnected from its source of supply.

5-9. Make sure that only fuses with the required rated current and of the specified type (normal blow, time delay, etc.) are used for replacement. The use of repaired fuses and the shortcircuiting of fuseholders should be avoided.

5-10. Whenever it is likely that the protection offered by fuses has been impaired, the instrument should be made inoperative and secured against any unintended operation.

WARNING

Adjustments described herein are performed with power supplied to the instrument while protective covers are removed. Energy available at many points may, if contacted, result in personal injury.

5-11. RELATED ADJUSTMENTS

5-12. The +20-volt power supply regulator furnishes reference voltage to some of the other power supply regulators, therefore, the +20-volt regulator must always be adjusted first. If the sequence in the procedure is followed, a minimum of interaction between controls is present.

5-13. ADJUSTMENT LOCATIONS

5-14. Figures 5-6 and 5-7 show the location of each test point and adjustment control for the Model 8620C Sweeper.

Table 5-1. Controls Listed in Adjustment Sequence

Reference Designation	Adjustment Paragraph	Board Name	Common Name	Function Adjusted
A4R5	5-15	ADJ +20	+20V Adjust	Sets +20 Volt regulator
A5R9	5-15	ADJ -40	-40V Adjust	Sets -40 Volt regulator
A5R12	5-15	ADJ -10	-10V Adjust	Sets -10 Volt regulator
A4R32	5-15	ADJ +5	+5V Adjust	Sets +5 Volt regulator
A7R10	5-16	FAN SPEED	FAN SPEED	Sets fan speed to 3000 RPM (20 ms period)
A7R35	5-16	BAL	FAN BALANCE	Sets fan waveform symmetry
A7R27	5-17	1KHz	1 kHz Adjust	Sets internal modulation oscillator to 1 kHz (1 ms period)
A1R12	5-18	RANGE	SWEEP RANGE	Adjusts minimum sweep time at slowest sweep speed setting
A1R35	5-18	OFFSET	SWEEP SYM	Adjusts symmetry of sweep time to sweep return time
A1R11	5-18	SWP	SWEEP TIME	Adjusts sweep time
A1R10	5-18	RET	RETURN TIME	Adjusts sweep return time
A2R21	5-19	A	SWP 0V	Sets 0 Vdc for low end of sweep ramp
A2R22	5-19	B	SWP 10V	Sets +10 Vdc for high end of sweep ramp
A2R44	5-20	S	STOP MARK LO	Sets Stop Marker position at low frequency end of scale in FULL SWEEP
A2R35	5-20	P	STOP MARK HI	Sets Stop Marker position at high frequency end of scale in FULL SWEEP
A2R41	5-20	K	START MARK LO	Sets Start Marker position at low frequency end of scale in FULL SWEEP
A2R27	5-20	N	START MARK HI	Sets Start Marker position at high frequency end of scale in FULL SWEEP
A2R55	5-21	F	START FREQ LO	Sets Start Marker frequency at low end of scale in MARKER SWEEP
A2R26	5-21	M	START FREQ HI	Sets Start Marker frequency at high end of scale in MARKER SWEEP
A2R25	5-21	L	STOP FREQ LO	Sets Stop Marker frequency at low end of scale in MARKER SWEEP
A2R36	5-21	R	STOP FREQ HI	Sets Stop Marker frequency at high end of scale in MARKER SWEEP
A2R43	5-22	V	CW MARK LO	Sets CW Marker position at low frequency end of scale in FULL SWEEP
A2R33	5-22	T	CW MARK HI	Sets CW Marker position at high frequency end of scale in FULL SWEEP
A2R50	5-22	H	CW FREQ LO	Sets CW frequency at low end of scale
A2R29	5-22	U	CW FREQ HI	Sets CW frequency at high end of scale
A2R57	5-23	C	CWV CAL	Calibrates CW VERNIER control
A2R46	5-24	D	ΔF OFFSET	Adjusts ΔF offset amplifier symmetry
A2R49	5-24	J	ΔF SYM	Adjusts ΔF symmetry
A2R42	5-24	E	ΔF AMPLITUDE	Adjusts ΔF amplitude
Option 001 Only				
A6R1	5-25	OFFSET	DAC 0V	Adjusts for 0 Vdc at low frequency end
A6R2	5-25	REF	DAC 10V	Adjusts for +10 Vdc at high frequency end
Option 011 Only				
A12R11	5-26	LO	DAC 0V	Adjusts for 0 Vdc at low frequency end
A12R12	5-26	HI	DAC 10V	Adjusts for +10 Vdc at high frequency end

ADJUSTMENTS

NOTE

Before performing any adjustments, allow 30 minutes warm-up time for the instrument.

NOTE

When a test point has a common connection with RF Section interface connector J6, the pin on J6 will be noted at the end of a sentence in parenthesis. This allows the use of the service board at J6 for faster connection to the desired point.

NOTE

Ground DVM to ground pin on board being probed or to 36-pin service board pin 10 (J6-10).

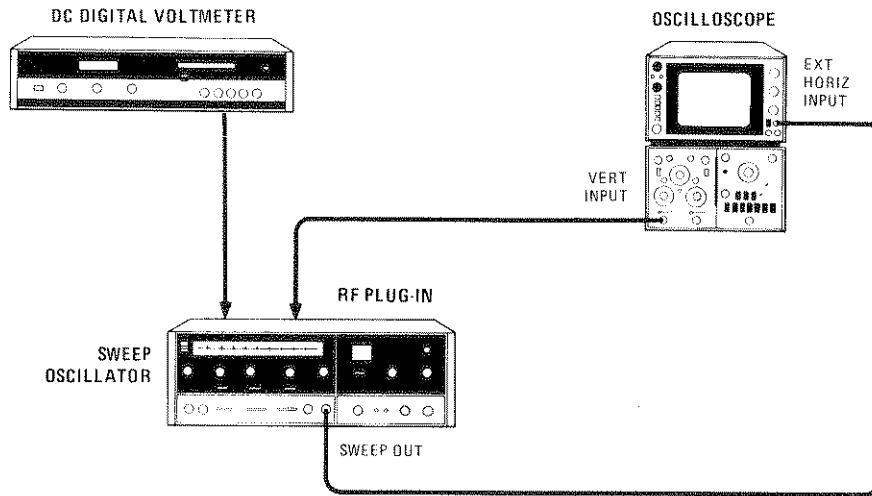

Figure 5-1. Adjustment Test Setup

5-15. POWER SUPPLY ADJUSTMENTS

REFERENCE: Service Sheet 4, +20V and +5V REGULATOR ASSEMBLY; and Service Sheet 5, -10V and -40V REGULATOR ASSEMBLY.

DESCRIPTION: The A4 and A5 Regulator Assemblies are adjusted to provide the proper dc voltages for the 8620C Sweep Oscillator and RF units connected in the mainframe. (See Figure 5-1 for test setup.)

EQUIPMENT: Digital Multimeter HP 3490A

ADJUSTMENTS

5-15. POWER SUPPLY ADJUSTMENTS (Cont'd)

PROCEDURE: *+20 Volt Supply*

- a. Connect digital voltmeter to +20 test point on A4 Assembly (J6-34), and connect ground lead to GND.
- b. Adjust +20 ADJ A4R5 for +20.000 Vdc \pm 0.006 Vdc.

-40 Volt Supply

- c. Connect digital voltmeter to -40 test point on A5 Assembly (J6-29), and connect ground lead to GND.
- d. Adjust -40 ADJ A5R9 for -40.000 Vdc \pm 0.020 Vdc.

-10 Volt Supply

- e. Connect digital voltmeter to -10 test point on A5 Assembly (J6-31), verify ground lead connected to GND.
- f. Adjust -10 ADJ A5R12 for -10.000 Vdc \pm 0.004 Vdc.

+5 Volt Supply

- g. Connect digital voltmeter to +5 test point on A4 Assembly (J6-33), and connect ground lead to GND.
- h. Adjust +5 ADJ A4R32 for +5.000 Vdc \pm 0.005 Vdc.

5-16. FAN ADJUSTMENTS

REFERENCE: Service Sheet 7, OPERATIONS CONTROL ASSEMBLY.

DESCRIPTION: Fan Speed and ON/OFF ratio are adjusted for maximum efficiency (see Figure 5-1 for test setup).

EQUIPMENT: Oscilloscope (with 10:1 probes) HP 181A/1801A/1820C

- PROCEDURE:**
- a. Connect oscilloscope Channel A to A7TP6 (Q5 collector) and oscilloscope Channel B to A7TP7 (Q7 collector). Connect oscilloscope ground lead to A7TP8.
 - b. Adjust FAN SPEED A7R10 for a 20 ms period on oscilloscope. This corresponds to 3000 RPM.
 - c. Adjust BAL A7R35 to balance ON time of Channel A waveform to ON time of Channel B and OFF time of Channel A to OFF time of Channel B.

ADJUSTMENTS

5-16. FAN ADJUSTMENTS (Cont'd)

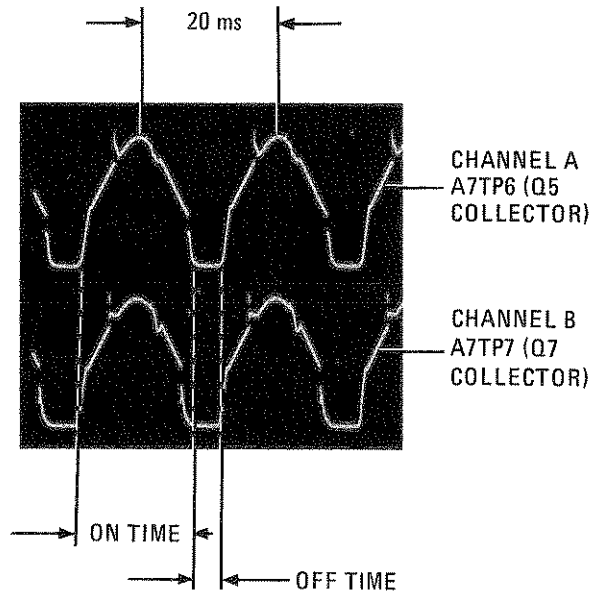

Figure 5-2. Oscilloscope Display of Fan Waveforms

5-17. 1 kHz MODULATION ADJUSTMENT

REFERENCE: Service Sheet 7, OPERATIONS CONTROL ASSEMBLY.

DESCRIPTION: 1 kHz Oscillator is adjusted for proper operating frequency (see Figure 5-1 for test setup).

EQUIPMENT: Oscilloscope (with 10:1 probe) HP 181A/1801A/1820C

- PROCEDURE:
- a. Set rear-panel 1 kHz SQ WV/OFF slide switch to 1kHz SQ WV.
 - b. Connect oscilloscope to test point 5 on A7 (J6-6), and connect oscilloscope ground lead to test point 7 (ground) on A7.
 - c. Adjust 1 kHz A7R27 for 1 ms ± 0.05 ms period on oscilloscope. This corresponds to 1 kHz.

5-18. SWEEP GENERATOR BOARD ADJUSTMENTS

REFERENCE: Service Sheet 1, SWEEP GENERATOR ASSEMBLY.

DESCRIPTION: Set correct sweep time, sweep return time, symmetry, and range of RF Blanking signal (see Figure 5-1 for test setup).

EQUIPMENT: Oscilloscope HP 181A/1801A/1820C
 10:1 Probe HP 10004B
 1:1 Probe HP 10008B

 ADJUSTMENTS

5-18. SWEEP GENERATOR BOARD ADJUSTMENTS (Cont'd)

- PROCEDURE:
- a. Connect oscilloscope VERTICAL input to A1TP9 (10:1 Probe), and ground lead to A1TP12.
 - b. Connect oscilloscope EXT TRIGGER input to A1TP9 (1:1 Probe), and set oscilloscope trigger controls to EXT, NORM, and (−) SLOPE.
 - c. Press FULL SWEEP pushbutton; pushbutton should light.
 - d. Set 8620C Sweep MODE switch to AUTO.
 - e. Set 8620C sweep TRIGGER switch to INT.
 - f. Set 8620C TIME-SECONDS switch to .1 — .01 and turn TIME-SECONDS Vernier control fully clockwise.
 - g. Adjust oscilloscope for display as shown in Figure 5-3.
 - h. Set A1R12 RANGE and A1R35 OFFSET controls to center of range.
 - i. Adjust A1R11 SWP control for $t_1 = 10.8 \text{ msec} \pm 0.5 \text{ msec}$. Adjust A1R10 RET control for $t_2 = 5.4 \text{ msec} \pm 0.5 \text{ msec}$.
 - j. Set 8620C TIME-SECONDS Vernier control fully counterclockwise. Connect a 19.6K 1% resistor between A1TP4 and A1TP12.
 - k. Adjust oscilloscope sweep time so that t_2 occupies 1.0 division of the display. Adjust A2R35 OFFSET control so that t_1 occupies 6.5 divisions of the display. Symmetry is now set to 6.5:1.
 - l. Remove 19.6K resistor. With oscilloscope sweep time in a calibrated mode, adjust A1R12 RANGE control for $t_1 = 282 \text{ msec} \pm 5.0 \text{ msec}$.
 - m. Connect 19.6K resistor between A1TP4 and A1TP12. Verify symmetry between 6.5:0.7 and 6.5:1.3.
 - n. Set 8620C TIME-SECONDS Vernier control fully clockwise. t_1 should be between 32.5ms and 37.5ms (19.6K resistor still connected); if not, select a new value between 51.1K and 110K for A1R3.

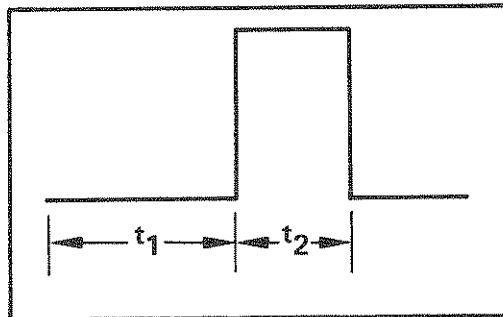

Figure 5-3. Oscilloscope Display of Waveform Symmetry

ADJUSTMENTS

5-19. FULL SWEEP ADJUSTMENT

REFERENCE: Service Sheet 2, FREQUENCY CONTROL ASSEMBLY.

DESCRIPTION: Sets zero to +10 Volt sweep ramp.

EQUIPMENT: Digital Multimeter HP 3480D/3484A

- PROCEDURE:
- a. Connect equipment as shown in Figure 5-1.
 - b. Select calibration scale with band select switch.
 - c. Press FULL SWEEP pushbutton. Set sweep MODE to MANUAL and MANUAL control fully counterclockwise.
 - d. Connect DVM input to A2TP3 and ground lead to GND on A4 board.
 - e. Set adjustment A (SWP 0V) (A2R21) for DVM indication of 0.000 Vdc \pm 0.001 Vdc.
 - f. Turn MANUAL control fully clockwise. Set adjustment B (SWP 10V) (A2R22) for DVM indication of +10.000 Vdc \pm 0.005 Vdc.

5-20. START MARKER/STOP MARKER ADJUSTMENT

REFERENCE: Service Sheet 2, FREQUENCY CONTROL ASSEMBLY.

DESCRIPTION: Sets correct voltages to calibrate STOP MARKER and START MARKER controls.

EQUIPMENT: Digital Multimeter HP 3490A

NOTE

If STOP MARKER potentiometer R6 on START MARKER potentiometer 22 has been replaced, refer to Paragraph 5-27 for mechanically zero.

- PROCEDURE:
- a. Set Stop Marker (red pointer) to 0 Volt mark on calibration scale. Connect DVM to A2TP2.
 - b. Set adjustment S (STOP MARK LO) (A2R44) for DVM indication of 0.000 Vdc \pm 0.001 Vdc.
 - c. Set Stop Marker to 10 Volt mark on calibration scale. Set adjustment P (STOP MARK HI) (A2R35) for DVM indication of +10.000 Vdc \pm 0.005 Vdc.
 - d. Connect DVM input to A2TP1. Set Start Marker to 0 Volt mark on calibration scale.
 - e. Set adjustment K (START MARK LO) (A2R41) for DVM indication of 0.000 Vdc \pm 0.001 Vdc.
 - f. Set Start Marker to 10 Volt mark on calibration scale. Set adjustment N (START MARK HI) (A2R27) for DVM indication of +10.000 Vdc \pm 0.005 Vdc.

ADJUSTMENTS

5-21. MARKER SWEEP ADJUSTMENT

REFERENCE: Service Sheet 2, FREQUENCY CONTROL ASSEMBLY.

DESCRIPTION: Sets correct voltages to calibrate MARKER SWEEP OPERATION.

EQUIPMENT: Digital Multimeter HP 3490A

- PROCEDURE:**
- a. Press MARKER SWEEP pushbutton. Set MANUAL control fully counterclockwise. Set STOP MARKER to 5 Volt mark on calibration scale.
 - b. Connect DVM input to A2TP5. Set Start Market to 0 Volt mark on calibration scale. Set adjustment F (START FREQ LO) (A2R55) for DVM indication of $0.000 \text{ Vdc} \pm 0.001 \text{ Vdc}$.
 - c. Set Start Marker to 10 Volt mark on calibration scale. Turn MANUAL control fully clockwise. Set adjustment L (STOP FREQ LO) (A2R25) for DVM indication of $0.000 \text{ Vdc} \pm 0.005 \text{ Vdc}$.
 - e. Set Stop Marker to 10 Volt mark on calibration scale. Set adjustment R (STOP FREQ HI) (A2R36) for DVM indication of $+10.000 \text{ Vdc} \pm 0.005 \text{ Vdc}$.

5-22. CW/CW MARKER ADJUSTMENT

REFERENCE: Service Sheet 2, FREQUENCY CONTROL ASSEMBLY.

DESCRIPTION: Sets correct voltages for calibration of CW frequency and CW MARKER control.

EQUIPMENT: Digital Multimeter HP 3490A

NOTE

If CW MARKER potentiometer R4 has been replaced, refer to Paragraph 5-27 for mechanical zero.

- PROCEDURE:**
- a. Press FULL SWEEP pushbutton. Connect DVM input to A2TP4.
 - b. Set CW Marker (white pointer) to 0 Volt mark on calibration scale.
 - c. Set adjustment V (CW MARK LO) (A2R43) for DVM indication of $0.000 \text{ Vdc} \pm 0.001 \text{ Vdc}$.
 - d. Set CW Marker to 10 Volt mark on calibration scale. Set adjustment T (CW MARK HI) (A2R33) for DVM indication of $+10.000 \text{ Vdc} \pm 0.005 \text{ Vdc}$.
 - e. Press CW pushbutton. Connect DVM input to A2TP5. Set CW Marker to 0 Volt mark on calibration scale. Set adjustment H (CW FREQ LO) (A2R50) for DVM indication of $0.000 \text{ Vdc} \pm 0.001 \text{ Vdc}$.
 - f. Set CW Marker to 10 Volt mark on calibration scale. Set adjustment U (CW FREQ HI) (A2R29) for DVM indication of $+10.000 \text{ Vdc} \pm 0.005 \text{ Vdc}$.
-

ADJUSTMENTS

5-23. CW VERNIER ADJUSTMENT

REFERENCE: Service Sheet 2, FREQUENCY CONTROL ASSEMBLY.

DESCRIPTION: Sets correct voltages for calibration of CW VERNIER control.

EQUIPMENT: Digital Multimeter HP 3490A

NOTE

If CW VERNIER potentiometer R5 has been replaced, refer to Paragraph 5-27 for mechanical zero.

- PROCEDURE:
- a. Verify DVM connected to A2TP5. Set CW Marker to 0 Volt mark on calibration scale and adjust CW MARKER control for DVM indication of 0.000 Vdc \pm 0.001 Vdc.
 - b. Press CW VERNIER pushbutton. Set CW VERNIER pointer to +5 Volt mark on calibration scale. Set CW VERNIER Multiplier to X1.
 - c. DVM indication should be +0.500 Vdc \pm 0.007 Vdc. Record this reading.
 - d. Set CW VERNIER pointer to -5 Volt mark on calibration scale. Set adjustment C (CWV CAL) (A2R57) for DVM indication of same magnitude \pm 0.002 Vdc as recorded in step (d) but of opposite polarity.
 - e. Set CW VERNIER pointer to 0 Volt mark on calibration scale. DVM indication should be 0.000 Vdc \pm 0.010 Vdc.
 - f. If test limit is not met in step (f), reset adjustment C. Recheck DVM indication at +5 Volt mark and -5 Volt mark for test limit.

5-24. Δ F ADJUSTMENT

REFERENCE: Service Sheet 2, FREQUENCY CONTROL ASSEMBLY.

DESCRIPTION: Sets correct voltages for calibration of Δ F operation.

EQUIPMENT: Digital Multimeter HP 3490A

NOTE

If Δ F potentiometer R3 has been replaced, refer to Paragraph 5-27 for mechanical zero.

- PROCEDURE:
- a. Connect DVM to A2TP5. Adjust CW and CW VERNIER controls for DVM indication of +5.000 Vdc \pm 0.001 Vdc.
 - b. Press Δ F pushbutton. Set Δ F Multiplier to X10. Set Δ F pointer to 0 Volt mark on calibration scale.
 - c. Connect DVM to A2TP3. Adjust MANUAL control for DVM indication of +5.000 Vdc \pm 0.005 Vdc.

ADJUSTMENTS

5-24. ΔF ADJUSTMENT (Cont'd)

- d. Connect DVM input to A2TP6. Set adjustment D (ΔF OFFSET) (A2R46) for DVM indication of $0.000 \text{ Vdc} \pm 0.001 \text{ Vdc}$.
- e. Connect DVM to A2TP5. Set ΔF pointer to +5 Volt mark on calibration scale. While continually rotating MANUAL control between full clockwise and full counterclockwise positions, set adjustment J (ΔF SYM) (A2R49) for symmetry.
- f. Rotate MANUAL control continually between full clockwise position and full counterclockwise position and set adjustment E (ΔF AMPLITUDE) (A2R42) for $0.000 \text{ Vdc} \pm 0.001 \text{ Vdc}$ at clockwise position and $+10.000 \text{ Vdc} \pm 0.0001 \text{ Vdc}$ at counterclockwise position.

5-25. DIGITAL-TO-ANALOG CONVERTER ADJUSTMENT (Option 001 Only)

REFERENCE: Service Sheet 6, DIGITAL-TO-ANALOG CONVERTER ASSEMBLY.

DESCRIPTION: Sets calibration adjustment for A6 Assembly (refer to Figure 5-1 for test setup).

EQUIPMENT: Digital Multimeter HP 3490A

- PROCEDURE:
- a. Connect DVM to 36-pin service board (HP Part No. 08620-60037) pin 1 (tuning voltage output) (J6-1) and connect ground lead to ground pin on service board (J6-10).
 - b. Install 50-pin service board (HP Part No. 08620-60125) on rear-panel PROGRAMMING connector J2.
 - c. Set remote D/A enable switch (R D/A) to GND. Set all BCD input switches (8V, 4V, 2V, 1V, etc.) to GND.
 - d. Adjust OFFSET A6R1 for $0.0000 \text{ Vdc} \pm 0.0005 \text{ Vdc}$ indication on DVM.
 - e. Set 8V and 2V BCD switches to OPEN.
 - f. Adjust REF A6R2 for $+10.0000 \text{ Vdc} \pm 0.0005 \text{ Vdc}$ indication on DVM.

5-26. DIGITAL-TO-ANALOG CONVERTER ADJUSTMENT (Option 011 Only)

REFERENCE: Service Sheet 6A. A12 HP-IB Interface Assembly

DESCRIPTION: Assures that the programmed digital-control-voltage input is converted to the correct analog tuning voltage. The 0V and 10V references are set by two adjustments, LO (0V) and HI (10V), on the A12 HP-IB Interface Assembly.

ADJUSTMENTS

5-26. DIGITAL-TO-ANALOG CONVERTER ADJUSTMENT (Option 011 Only) (Cont'd)

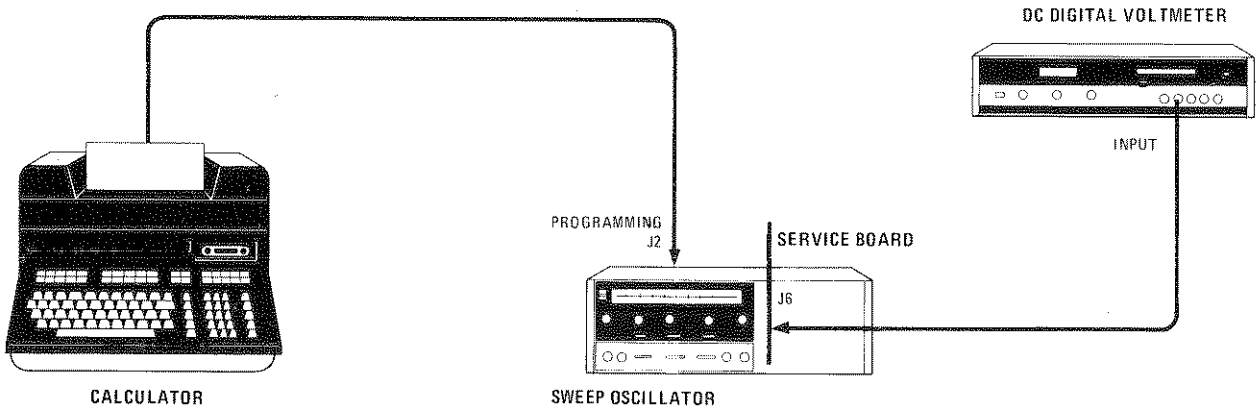

Figure 5-4. D/A Converter Adjustment Test Setup

EQUIPMENT:

Digital Multimeter	HP 3490A
Calculator	HP 9830A
HP-IB Calculator Interface	HP 59405A (Option 030)
36-Pin Service Board	HP 08620-60036
HP-IB Interface Cable	HP 10631A/B/C

NOTE

For this adjustment, the HP Model 59401A Bus System Analyzer or any other HP-IB controller may be substituted for the HP 9830A Calculator.

- PROCEDURE:
- a. Remove 8620C top cover and insert 36-pin service board at J6.
 - b. Connect DVM to service board pin 1 (tuning voltage output) (J6-1) and connect ground lead to ground pin on service board (J6-10).
 - c. Connect calculator or bus system analyzer to 8620C PROGRAMMING connector J2.
 - d. Press 8620C LINE pushbutton ON.
 - e. Address 8620C, program FULL SWEEP mode REMOTE, and select zero volts.
CMD "?U&", M1V0E
 - f. Adjust LO A12R11 for 0.0000 Vdc \pm 0.0005 Vdc indication on DVM.
 - g. Program for 10 volts: V: 000E
 - h. Adjust H1 A12R12 for +10.0000 Vdc \pm 0.0005 Vdc indication on DVM.

ADJUSTMENTS

5-27. MECHANICAL ZERO ADJUSTMENT

REFERENCE: Figure 5-5. Mechanical Zero Adjustment Locations.

DESCRIPTION: Sets mechanical zero of START MARKER, ΔF , CW MARKER, CW VERNIER, and STOP MARKER controls. One adjustment procedure is shown for all controls and the indications are the same for each control except for CW VERNIER. The CW VERNIER readings are shown in parentheses.

NOTE

This adjustment should be performed in conjunction with frequency or marker control adjustments and only when one of the potentiometers has been replaced. Refer to paragraphs 5-19 through 5-24.

- PROCEDURE:**
- a. Locate minimum resistance point of control by rotating control about 0 Volt scale mark (+5 Volt scale mark for CW VERNIER) while monitoring voltage reading on DVM. Minimum resistance point is indicated by minimum voltage reading on DVM. (CW VERNIER control is adjusted for a DVM reading of +0.500 Vdc \pm 0.005 Vdc).
 - b. Loosen set screws in shaft collar as shown in Figure 5-5 using a right-angle 4-spline (Bristol) wrench (HP Part No. 8710-0055).
 - c. Align pointer to 0 Volt scale mark (+5 Volt scale mark for CW VERNIER) by first setting pointer to left-edge stop, then adjusting up-scale to 0 Volt scale mark (+5 Volt scale mark for CW VERNIER).
 - d. Tighten set screws in shaft collar.
 - e. Locate minimum resistance point of control and check alignment of pointer (adjust for +0.500 Vdc \pm 0.005 Vdc for CW VERNIER). If pointer is not aligned to scale mark, loosen set screws in collar and realign pointer.
 - f. Repeat this process until pointer is aligned to scale mark. Alignment is complete when DVM indicates minimum voltage (+0.500 Vdc \pm 0.005 Vdc for CW VERNIER).

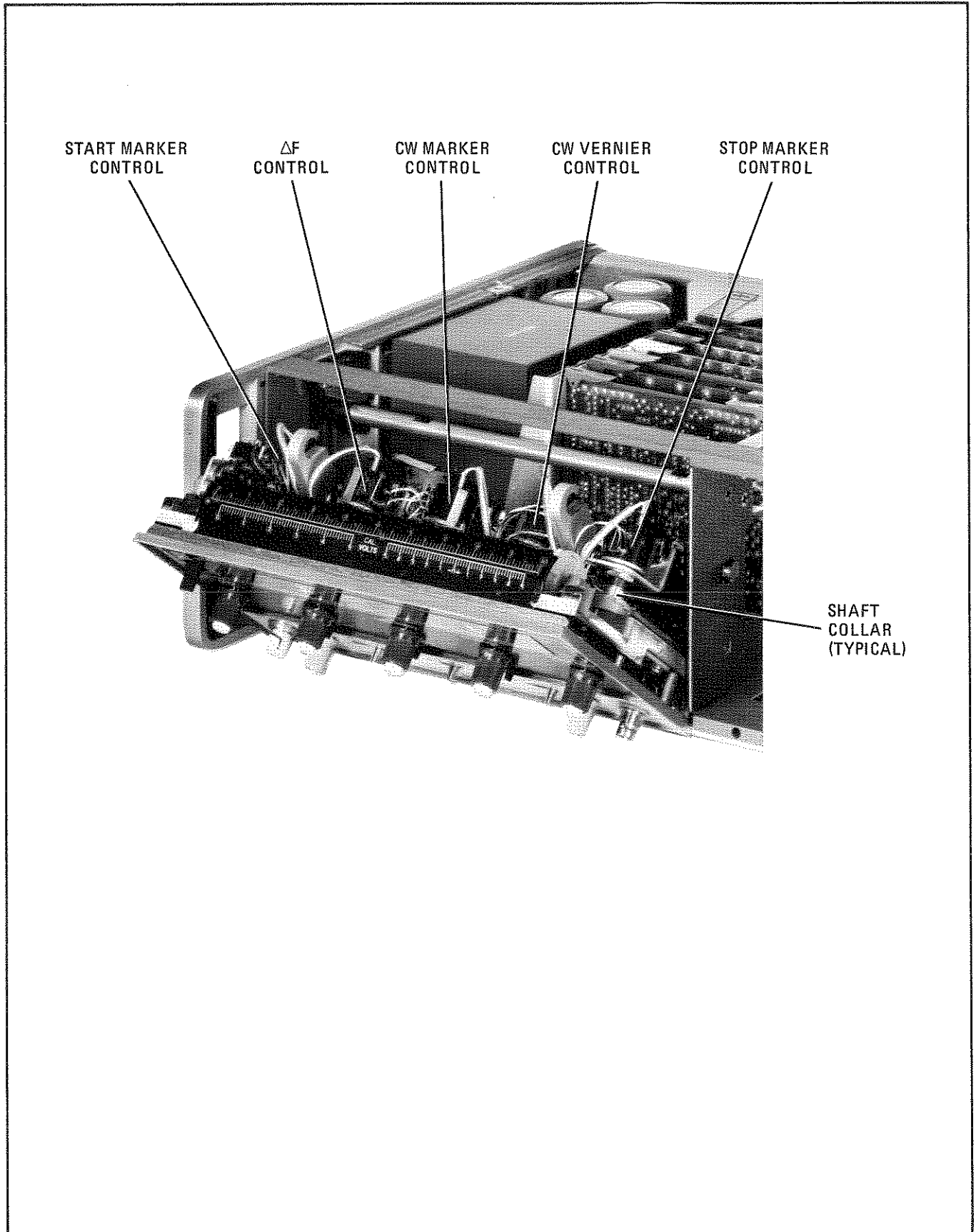

Figure 5-5. Mechanical Zero Adjustment Locations

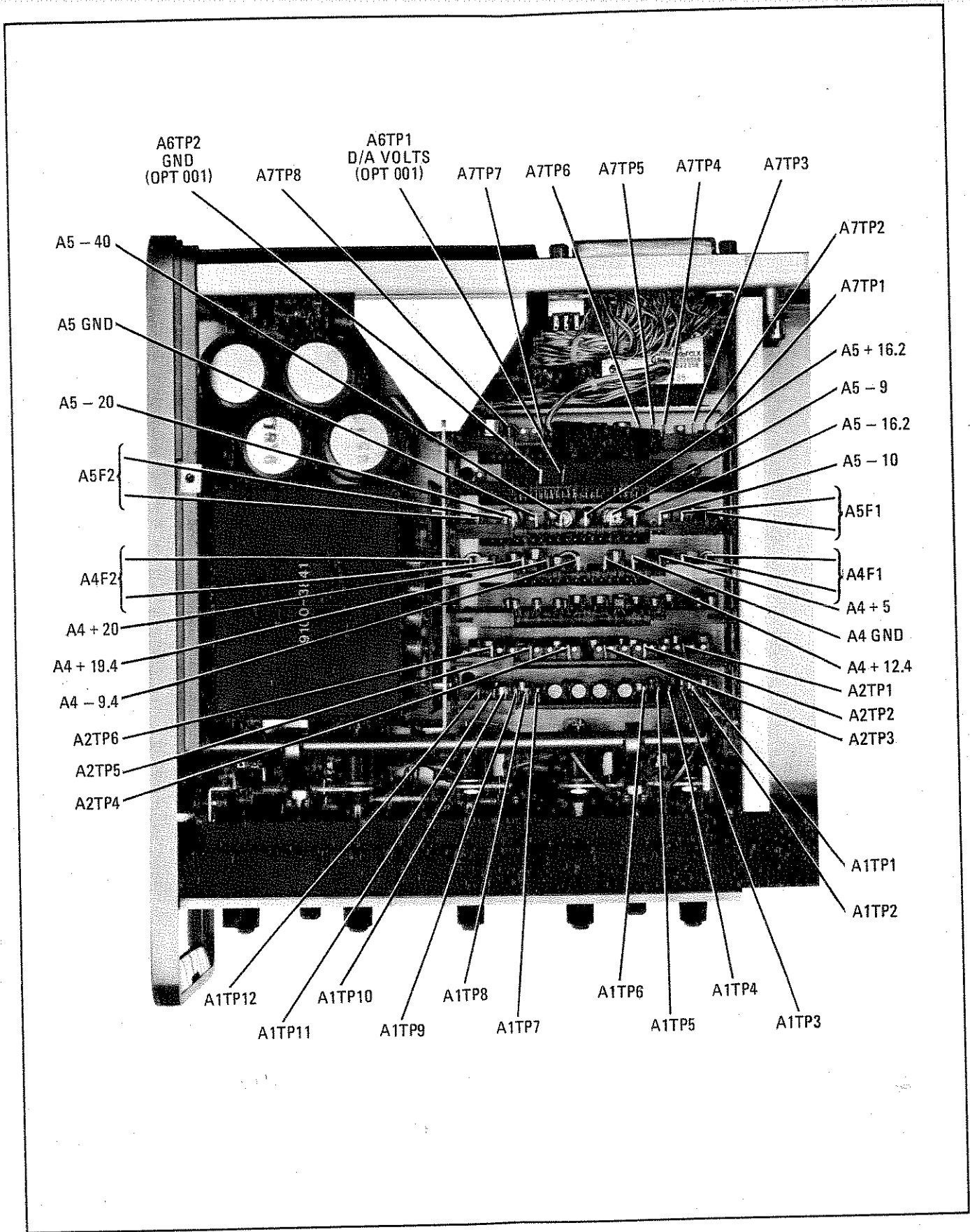

Figure 5-6. Location of Test Points

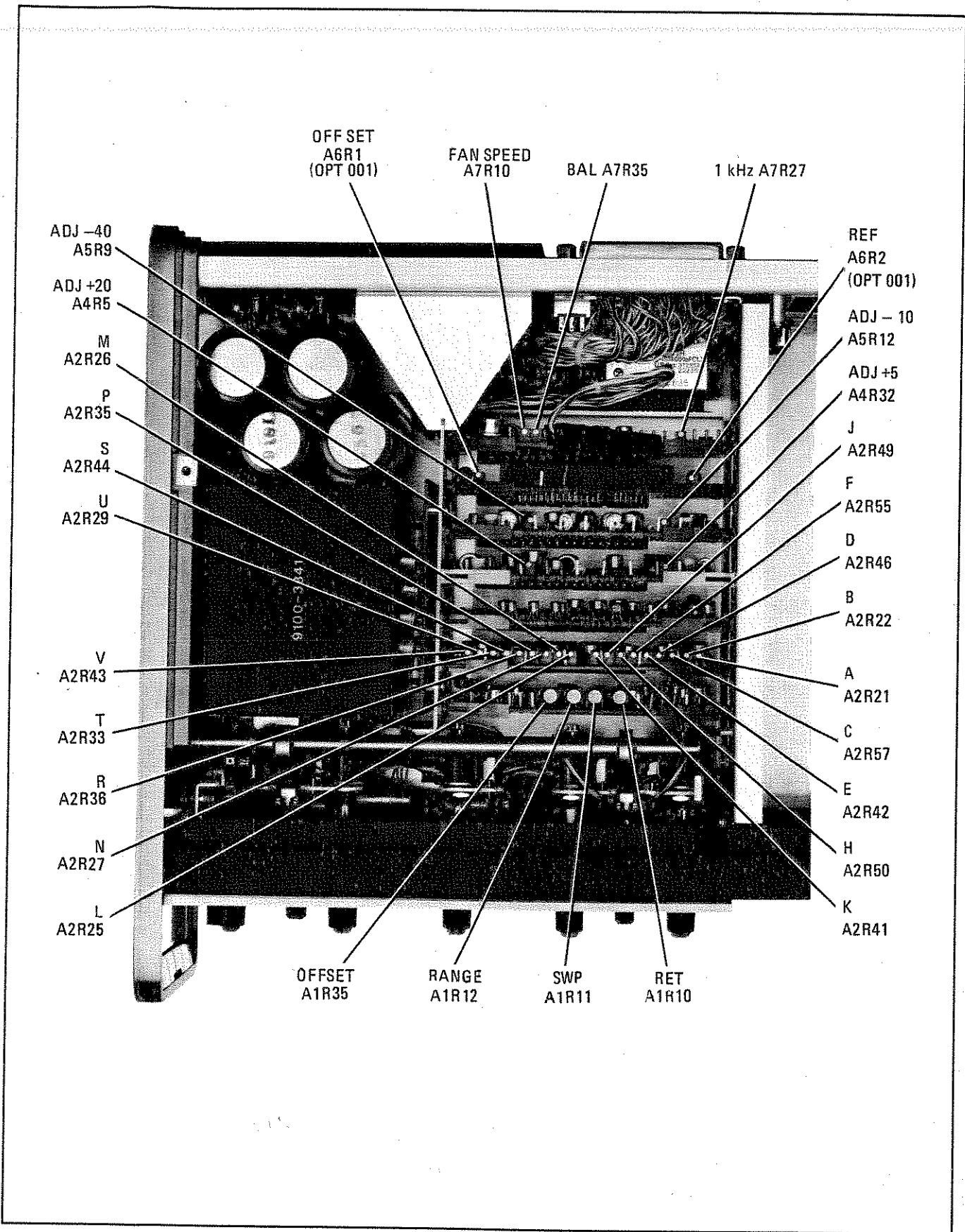

Figure 5-7. Location of Adjustments

SECTION VI REPLACEABLE PARTS

6-1. INTRODUCTION

6-2. This section contains information for ordering parts. Table 6-1 lists abbreviations used in the parts list and throughout the manual. Table 6-2 lists all replaceable parts in reference designator order. Table 6-3 contains names and addresses that correspond to the manufacturer's code numbers.

6-3. ABBREVIATIONS

6-4. Table 6-1 lists abbreviations used in the parts list, schematics and throughout the manual. In some cases, two forms of the abbreviation are given; one uses all capital letters, and one partial or no capitals. This occurs because the abbreviations in the parts list are always in capitals. However, in the schematics and other parts of the manual, other abbreviation forms are used with both lower case and upper case letters.

6-5. REPLACEABLE PARTS LIST

6-6. Table 6-2 is the list of replaceable parts and is organized as follows:

- a. Electrical assemblies and their components in alpha-numerical order by reference designation.
- b. Chassis-mounted parts in alpha-numeric order by reference designation.
- c. Miscellaneous parts.
- d. Illustrated parts breakdown, if appropriate.

6-7. The information given for each part consists of the following:

- a. The Hewlett-Packard part number.
- b. The total quantity (Qty) in the instrument.
- c. The description of the part.
- d. The typical manufacturer of the part in a five-digit code.
- e. Manufacturer code number for the part.

NOTE

The total quantity for each part is given only once — at the first appearance of the part number in the list.

6-8. ORDERING INSTRUCTIONS

6-9. To order a part listed in the replaceable parts table, quote the Hewlett-Packard part number, indicate quantity required, and address the order to the nearest Hewlett-Packard office.

6-10. To order a part that is not listed in the replaceable parts table, include the instrument model number, instrument serial number, the description and function of the part, and the number of parts required. Address the order to the nearest Hewlett-Packard office.

Table 6-1. Reference Designations and Abbreviations (1 of 2)

REFERENCE DESIGNATIONS

A assembly
 AT attenuator; isolator; termination
 B fan; motor
 BT battery
 C capacitor
 CP coupler
 CR diode; diode thyristor; varactor
 DC directional coupler
 DL delay line
 DS annunciator; signaling device (audible or visual); lamp; LED

E miscellaneous electrical part
 F fuse
 FL filter
 H hardware
 HY circulator
 J electrical connector (stationary portion); jack
 K relay
 L coil; inductor
 M meter
 MP miscellaneous mechanical part

P electrical connector (movable portion); plug
 Q transistor; SCR; triode thyristor
 R resistor
 RT thermistor
 S switch
 T transformer
 TB terminal board
 TC thermocouple
 TP test point

U integrated circuit; microcircuit
 V electron tube
 VR voltage regulator; breakdown diode
 W cable; transmission path; wire
 X socket
 Y crystal unit (piezo-electric or quartz)
 Z tuned cavity; tuned circuit

ABBREVIATIONS

A ampere
 ac alternating current
 ACCESS accessory
 ADJ adjustment
 A/D analog-to-digital
 AF audio frequency
 AFC automatic frequency control
 AGC automatic gain control
 AL aluminum
 ALC automatic level control
 AM amplitude modulation
 AMPL amplifier
 APC automatic phase control
 ASSY assembly
 AUX auxiliary
 avg average
 AWG American wire gauge
 BAL balance
 BCD binary coded decimal
 BD board
 BE CU beryllium copper
 BFO beat frequency oscillator
 BH binder head
 BKDN breakdown
 BP bandpass
 BPF bandpass filter
 BRS brass
 BWO backward-wave oscillator
 CAL calibrate
 ccw counter-clockwise
 CER ceramic
 CHAN channel
 cm centimeter
 CMO cabinet mount only
 COAX coaxial

COEF coefficient
 COM common
 COMP composition
 COMPL complete
 CONN connector
 CP cadmium plate
 CRT cathode-ray tube
 CTL complementary transistor logic
 CW continuous wave
 cw clockwise
 cm centimeter
 D/A digital-to-analog
 dB decibel
 dBm decibel referred to 1 mW
 dc direct current
 deg degree (temperature interval or difference)
 ° degree (plane angle)
 °C degree Celsius (centigrade)
 °F degree Fahrenheit
 °K degree Kelvin
 DFPC deposited carbon
 DET detector
 diam diameter
 DIA diameter (used in parts list)
 DIFF AMPL differential amplifier
 div division
 DPDT double-pole, double-throw
 DR drive
 DSB double sideband
 DTL diode transistor logic
 DVM digital voltmeter
 ECL emitter coupled logic
 EMF electromotive force

EDP electronic data processing
 ELECT electrolytic
 ENCAP encapsulated
 EXT external
 F farad
 FET field-effect transistor
 F/F flip-flop
 FH flat head
 FIL H fillister head
 FM frequency modulation
 FP front panel
 FREQ frequency
 FXD fixed
 g gram
 GE germanium
 GHz gigahertz
 GL glass
 GND ground(ed)
 H henry
 h hour
 HET heterodyne
 HEX hexagonal
 HD head
 HDW hardware
 HF high frequency
 HG mercury
 HI high
 HP Hewlett-Packard
 HPF high pass filter
 HR hour (used in parts list)
 HV high voltage
 Hz Hertz
 IC integrated circuit
 ID inside diameter
 IF intermediate frequency
 IMPG impregnated
 in inch
 INCD incandescent
 INCL include(s)
 INP input
 INS insulation

INT internal
 kg kilogram
 kHz kilohertz
 kΩ kilohm
 kV kilovolt
 lb pound
 LC inductance-capacitance
 LED light-emitting diode
 LF low frequency
 LG long
 LH left hand
 LIM limit
 LIN linear taper (used in parts list)
 lin linear
 LK WASH lock washer
 LO low; local oscillator
 LOG logarithmic taper (used in parts list)
 log logarithm(ic)
 LPF low pass filter
 LV low voltage
 m meter (distance)
 mA milliampere
 MAX maximum
 MΩ megohm
 MEG meg (10⁶) (used in parts list)
 MET FLM metal film
 MET OX metallic oxide
 MF medium frequency; microfarad (used in parts list)
 MFR manufacturer
 mg milligram
 MHz megahertz
 mH millihenry
 mho mho
 MIN minimum
 min minute (time)
 minute (plane angle)
 MINAT miniature
 mm millimeter

NOTE

All abbreviations in the parts list will be in upper-case.

Table 6-1. Reference Designations and Abbreviations (2 of 2)

MOD modulator	OD outside diameter	PWV peak working voltage	TD time delay
MOM momentary	OH oval head	RC resistance-capacitance	TERM terminal
MOS metal-oxide semiconductor	OP AMPL operational amplifier	RECT rectifier	TFT thin-film transistor
ms millisecond	OPT option	REF reference	TGL toggle
MTG mounting	OSC oscillator	REG regulated	THD thread
MTR meter (indicating device)	OX oxide	REPL replaceable	THRU through
mV millivolt	oz ounce	RF radio frequency	TI titanium
mVac millivolt, ac	Ω ohm	RFI radio frequency interference	TOL tolerance
mVdc millivolt, dc	P peak (used in parts list)	RH round head; right hand	TRIM trimmer
mVpk millivolt, peak	PAM pulse-amplitude modulation	RLC resistance-inductance-capacitance	TSTR transistor
mVp-p millivolt, peak-to-peak	PC printed circuit	RMO rack mount only	TTL transistor-transistor logic
mVrms millivolt, rms	PCM pulse-code modulation; pulse-count modulation	rms root-mean-square	TV television
mW milliwatt	PDM pulse-duration modulation	RND round	TVI television interference
MUX multiplex	pF picofarad	ROM read-only memory	TWT traveling wave tube
MY mylar	PH BRZ phosphor bronze	R&P rack and panel	U micro (10^{-6}) (used in parts list)
μ A microampere	PHL Phillips	RWV reverse working voltage	UF microfarad (used in parts list)
μ F microfarad	PIN positive-intrinsic-negative	S scattering parameter	UHF ultrahigh frequency
μ H microhenry	PIV peak inverse voltage	s second (time)	UNREG unregulated
μ mho micromho	pk peak	" second (plane angle)	V volt
μ s microsecond	PL phase lock	S-B slow-blow (fuse) (used in parts list)	VA voltampere
μ V microvolt	PLO phase lock oscillator	SCR silicon controlled rectifier; screw	Vac volts, ac
μ Vac microvolt, ac	PM phase modulation	SE selenium	VAR variable
μ Vdc microvolt, dc	PNP positive-negative-positive	SECT sections	VCO voltage-controlled oscillator
μ Vpk microvolt, peak	P/O part of	SEMICON semiconductor	Vdc volts, dc
μ Vp-p microvolt, peak-to-peak	POLY polystyrene	SHF superhigh frequency	VDCW volts, dc, working (used in parts list)
μ Vrms microvolt, rms	PORC porcelain	SI silicon	V(F) volts, filtered
μ W microwatt	POS positive; position(s) (used in parts list)	SIL silver	VFO variable-frequency oscillator
nA nanoampere	POSN position	SL slide	VHF very-high frequency
NC no connection	POT potentiometer	SNR signal-to-noise ratio	Vpk volts, peak
N/C normally closed	p-p peak-to-peak	SPDT single-pole, double-throw	Vp-p volts, peak-to-peak
NE neon	PP peak-to-peak (used in parts list)	SPG spring	Vrms volts, rms
NEG negative	PPM pulse-position modulation	SR split ring	VSWR voltage standing wave ratio
nF nanofarad	PRF AMPL preamplifier	SPST single-pole, single-throw	VTO voltage-tuned oscillator
NI PL nickel plate	PRF pulse-repetition frequency	SSB single sideband	VTVM vacuum-tube voltmeter
N/O normally open	PRR pulse repetition rate	SST stainless steel	V(X) volts, switched
NOM nominal	ps picosecond	STL steel	W watt
NORM normal	PT point	SQ square	W/ with
NPN negative-positive-negative	PTM pulse-time modulation	SWR standing-wave ratio	WIV working inverse voltage
NPO negative-positive zero (zero temperature coefficient)	PWM pulse-width modulation	SYNC synchronize	WW wirewound
NRFR not recommended for field replacement		T timed (slow-blow fuse)	W/O without
NSR not separately replaceable		TA tantalum	YIG yttrium-iron-garnet
ns nanosecond		TC temperature compensating	Z ₀ characteristic impedance
nW nanowatt			
OBD order by description			

NOTE

All abbreviations in the parts list will be in upper-case.

MULTIPLIERS

Abbreviation	Prefix	Multiple
T	tera	10^{12}
G	giga	10^9
M	mega	10^6
k	kilo	10^3
da	deka	10
d	deci	10^{-1}
c	centi	10^{-2}
m	milli	10^{-3}
μ	micro	10^{-6}
n	nano	10^{-9}
p	pico	10^{-12}
f	femto	10^{-15}
a	atto	10^{-18}

Table 6-2. Replaceable Parts

Reference Designation	HP Part Number	Qty	Description	Mfr Code	Mfr Part Number
A1	08620-60111	1	BOARD ASSEMBLY, SWEEP OSCILLATOR	28480	08620-60111
A1C1	0160-0572	2	CAPACITOR-FXD 2200PF +-20% 100WVDC CER	28480	0160-0572
A1C2	0160-0572		CAPACITOR-FXD 2200PF +-20% 100WVDC CER	28480	0160-0572
A1C3	0180-1735	1	CAPACITOR-FXD .22UF+-10% 35VDC TA	56289	150D224X9035A2
A1C4	0160-3879	4	CAPACITOR-FXD .01UF +-20% 100WVDC CER	28480	0160-3879
A1C5	0160-3876	6	CAPACITOR-FXD 1000PF +-20% 100WVDC CER	28480	0160-3876
A1C6	0160-3879		CAPACITOR-FXD .01UF +-20% 100WVDC CER	28480	0160-3879
A1C7	0160-2055	6	CAPACITOR-FXD .01UF +-80-20% 100WVDC CER	28480	0160-2055
A1CR1	1901-0040	16	DIODE-SWITCHING 30V 50MA 2NS DO-35	28480	1901-0040
A1CR2	1901-0040		DIODE-SWITCHING 30V 50MA 2NS DO-35	28480	1901-0040
A1CR3	1901-0040		DIODE-SWITCHING 30V 50MA 2NS DO-35	28480	1901-0040
A1CR4	1901-0040		DIODE-SWITCHING 30V 50MA 2NS DO-35	28480	1901-0040
A1CR5	1901-0040		DIODE-SWITCHING 30V 50MA 2NS DO-35	28480	1901-0040
A1CR6	1901-0040		DIODE-SWITCHING 30V 50MA 2NS DO-35	28480	1901-0040
A1CR7	1901-0040		DIODE-SWITCHING 30V 50MA 2NS DO-35	28480	1901-0040
A1CR8	1901-0040		DIODE-SWITCHING 30V 50MA 2NS DO-35	28480	1901-0040
A1CR9	1901-0040		DIODE-SWITCHING 30V 50MA 2NS DO-35	28480	1901-0040
A1CR10	1910-0016	2	DIODE-GE 60V 60NA 1US DO-7	28480	1910-0016
A1CR11	1901-0040		DIODE-SWITCHING 30V 50MA 2NS DO-35	28480	1901-0040
A1CR12	1901-0033	9	DIODE-GEN PRP 180V 200MA DO-7	28480	1901-0033
A1CR13	1901-0159	9	DIODE-PWR RECT 400V 750MA DO-41	04713	SR1358-4
A1CR14	1910-0016		DIODE-GE 60V 60NA 1US DO-7	28480	1910-0016
A1CR15	1901-0040		DIODE-SWITCHING 30V 50MA 2NS DO-35	28480	1901-0040
A1CR16	1901-0040		DIODE-SWITCHING 30V 50MA 2NS DO-35	28480	1901-0040
A1CR17	1901-0040		DIODE-SWITCHING 30V 50MA 2NS DO-35	28480	1901-0040
A1CR18	1901-0040		DIODE-SWITCHING 30V 50MA 2NS DO-35	28480	1901-0040
A1CR19	1901-0040		DIODE-SWITCHING 30V 50MA 2NS DO-35	28480	1901-0040
A1CR20	1901-0040		DIODE-SWITCHING 30V 50MA 2NS DO-35	28480	1901-0040
A1MP1	4040-0749	2	EXTR-PC BD BRN POLYC .062-BD-THKNS	28480	4040-0749
A1MP2	4040-0749		EXTR-PC BD BRN POLYC .062-BD-THKNS	28480	4040-0749
A1MP3	1480-0073	14	PIN:DRIVE 0.250" LG	00000	0HD
A1MP4	1480-0073		PIN:DRIVE 0.250" LG	00000	0HD
A1Q1	1854-0404	36	TRANSISTOR NPN SI TO-18 PD=360MW	28480	1854-0404
A1Q2	1854-0404		TRANSISTOR NPN SI TO-18 PD=360MW	28480	1854-0404
A1Q3	1854-0404		TRANSISTOR NPN SI TO-18 PD=360MW	28480	1854-0404
A1Q4	1853-0050	6	TRANSISTOR PNP SI TO-18 PD=360MW	28480	1853-0050
A1Q5	1854-0404		TRANSISTOR NPN SI TO-18 PD=360MW	28480	1854-0404
A1Q6	1854-0404		TRANSISTOR NPN SI TO-18 PD=360MW	28480	1854-0404
A1Q7	1854-0404		TRANSISTOR NPN SI TO-18 PD=360MW	28480	1854-0404
A1Q8	1855-0062	1	TRANSISTOR MOSFET P-CHAN D-MODE SI	28480	1855-0062
A1Q9	1855-0062	2	TRANSISTOR J-FET N-CHAN D-MODE SI	28480	1855-0062
A1Q10	1854-0404		TRANSISTOR NPN SI TO-18 PD=360MW	28480	1854-0404
A1Q11	1853-0050		TRANSISTOR PNP SI TO-18 PD=360MW	28480	1853-0050
A1Q12	1854-0404		TRANSISTOR NPN SI TO-18 PD=360MW	28480	1854-0404
A1Q13	1854-0474	2	TRANSISTOR NPN SI PD=310MW FT=100MHZ	28480	1854-0474
A1Q14	1854-0404		TRANSISTOR NPN SI TO-18 PD=360MW	28480	1854-0404
A1Q15	1855-0062		TRANSISTOR J-FET N-CHAN D-MODE SI	28480	1855-0062
A1Q16	1854-0404		TRANSISTOR NPN SI TO-18 PD=360MW	28480	1854-0404
A1Q17	1853-0050		TRANSISTOR PNP SI TO-18 PD=360MW	28480	1853-0050
A1Q18	1854-0404		TRANSISTOR NPN SI TO-18 PD=360MW	28480	1854-0404
A1Q19	1853-0050		TRANSISTOR PNP SI TO-18 PD=360MW	28480	1853-0050
A1Q20	1854-0079	1	TRANSISTOR NPN 2N3439 SI TO-5 PD=1W	02735	2N3439
A1Q21	1854-0474		TRANSISTOR NPN SI PD=310MW FT=100MHZ	28480	1854-0474
A1Q22	1854-0404		TRANSISTOR NPN SI TO-18 PD=360MW	28480	1854-0404
A1R1	0698-7236	8	RESISTOR 1K 1% .05W F TC=0+-100	24546	C3-1/8-T0-1001-G
A1R2	0698-7262	1	RESISTOR 12.1K 1% .05W F TC=0+-100	24546	C3-1/8-T0-1212-G
A1R3*	0757-0461	9	RESISTOR 68.1K 1% .125W F TC=0+-100 *FACTORY SELECTED PART	24546	C4-1/8-T0-6812-F
A1R4	0698-7275	1	RESISTOR 42.2K 1% .05W F TC=0+-100	24546	C3-1/8-T0-4222-G
A1R5	0698-7267	1	RESISTOR 19.6K 1% .05W F TC=0+-100	24546	C3-1/8-T0-1962-G
A1R6	0698-7277	3	RESISTOR 51.1K 1% .05W F TC=0+-100	24546	C3-1/8-T0-5112-G
A1R7	0698-7260	14	RESISTOR 10K 1% .05W F TC=0+-100	24546	C3-1/8-T0-1002-G
A1R8	0698-7272	3	RESISTOR 31.6K 1% .05W F TC=0+-100	24546	C3-1/8-T0-3162-G
A1R9	0698-7260		RESISTOR 10K 1% .05W F TC=0+-100	24546	C3-1/8-T0-1002-G
A1R10	2100-2517	2	RESISTOR-TRMR 50K 10% C SIDE-ADJ 1-TRN	30983	ET50X503
A1R11	2100-2517		RESISTOR-TRMR 50K 10% C SIDE-ADJ 1-TRN	30983	ET50X503
A1R12	2100-2520	1	RESISTOR-TRMR 50 20% C SIDE-ADJ 1-TRN	30983	ET50X500
A1R13	0698-7247	2	RESISTOR 2.87K 1% .05W F TC=0+-100	24546	C3-1/8-T0-2871-G
A1R14	0698-7247		RESISTOR 2.87K 1% .05W F TC=0+-100	24546	C3-1/8-T0-2871-G
A1R15	0698-7243	9	RESISTOR 1.96K 1% .05W F TC=0+-100	24546	C3-1/8-T0-1961-G
A1R16	0698-7263	2	RESISTOR 13.3K 1% .05W F TC=0+-100	24546	C3-1/8-T0-1332-G
A1R17	0698-7277		RESISTOR 51.1K 1% .05W F TC=0+-100	24546	C3-1/8-T0-5112-G
A1R18	0698-7238		RESISTOR 1.21K 1% .05W F TC=0+-100	24546	C3-1/8-T0-1211-G
A1R19	0698-6362	4	RESISTOR 1K .1% .125W F TC=0+-25	24546	NE55

See introduction to this section for ordering information

Table 6-2. Replaceable Parts

Reference Designation	HP Part Number	Qty	Description	Mfr Code	Mfr Part Number
A1R20	0698-7260	3	RESISTOR 10K 1% .05W F TC=0+-100	24546	C3-1/8-T0-1002-G
A1R21	0698-7260		RESISTOR 10K 1% .05W F TC=0+-100	24546	C3-1/8-T0-1002-G
A1R22	0683-1065		RESISTOR 10M 5% .25W FC TC=-900/+1100	01121	C81065
A1R23	0683-1065		RESISTOR 10M 5% .25W FC TC=-900/+1100	01121	C81065
A1R24	0698-7254		RESISTOR 5.62K 1% .05W F TC=0+-100	24546	C3-1/8-T0-5621-G
A1R25	0698-7229	3	RESISTOR 511 1% .05W F TC=0+-100	24546	C3-1/8-T0-511R-G
A1R26	0683-1065		RESISTOR 10M 5% .25W FC TC=-900/+1100	01121	C81065
A1R27	0698-7236		RESISTOR 1K 1% .05W F TC=0+-100	24546	C3-1/8-T0-1001-G
A1R28	0698-6362		RESISTOR 1K .1% .125W F TC=0+-25	24546	NESS
A1R29	0698-7260		RESISTOR 10K 1% .05W F TC=0+-100	24546	C3-1/8-T0-1002-G
A1R30	0698-6362	3	RESISTOR 1K .1% .125W F TC=0+-25	24546	NESS
A1R31	0698-7270		RESISTOR 26.1K 1% .05W F TC=0+-100	24546	C3-1/8-T0-2612-G
A1R32	0698-7208		RESISTOR 68.1 1% .05W F TC=0+-100	24546	C3-1/8-T0-68R1-G
A1R33	0698-7248		RESISTOR 3.16K 1% .05W F TC=0+-100	24546	C3-1/8-T0-3161-G
A1R34	0698-6362		RESISTOR 1K .1% .125W F TC=0+-25	24546	NESS
A1R35	2100-2516	1	RESISTOR-TMR 100K 1% C SIDE-ADJ 1-TRN	73138	62-231-1
A1R36	0698-7277		RESISTOR 51.1K 1% .05W F TC=0+-100	24546	C3-1/8-T0-5112-G
A1R37	0698-7282		RESISTOR 82.5K 1% .05W F TC=0+-100	24546	C3-1/8-T0-8252-G
A1R38	0698-7244		RESISTOR 2.15K 1% .05W F TC=0+-100	24546	C3-1/8-T0-2151-G
A1R39	0698-7236		RESISTOR 1K 1% .05W F TC=0+-100	24546	C3-1/8-T0-1001-G
A1R40	0698-7207	1	RESISTOR 61.9 1% .05W F TC=0+-100	24546	C3-1/8-T0-61R9-G
A1R41	0698-7243		RESISTOR 1.96K 1% .05W F TC=0+-100	24546	C3-1/8-T0-1961-G
A1R42	0698-7229		RESISTOR 511 1% .05W F TC=0+-100	24546	C3-1/8-T0-511R-G
A1R43	0698-7243		RESISTOR 1.96K 1% .05W F TC=0+-100	24546	C3-1/8-T0-1961-G
A1R44	0698-7243		RESISTOR 1.96K 1% .05W F TC=0+-100	24546	C3-1/8-T0-1961-G
A1R45	0698-7284	3	RESISTOR 100K 1% .05W F TC=0+-100	24546	C3-1/8-T0-1003-G
A1R46	0698-7260		RESISTOR 10K 1% .05W F TC=0+-100	24546	C3-1/8-T0-1002-G
A1R47	0698-3260		RESISTOR 464K 1% .125W F TC=0+-100	91637	CMF-55-1, T-1
A1R48	0698-7272		RESISTOR 31.6K 1% .05W F TC=0+-100	24546	C3-1/8-T0-3162-G
A1R49	0698-7264		RESISTOR 14.7K 1% .05W F TC=0+-100	24546	C3-1/8-T0-1472-G
A1R50	0698-7236	1	RESISTOR 1K 1% .05W F TC=0+-100	24546	C3-1/8-T0-1001-G
A1R51	0698-7257		RESISTOR 7.5K 1% .05W F TC=0+-100	24546	C3-1/8-T0-7501-G
A1R52	0698-7253		RESISTOR 5.11K 1% .05W F TC=0+-100	24546	C3-1/8-T0-5111-G
A1R53	0698-7232		RESISTOR 681 1% .05W F TC=0+-100	24546	C3-1/8-T0-681R-G
A1R54	0698-7272		RESISTOR 31.6K 1% .05W F TC=0+-100	24546	C3-1/8-T0-3162-G
A1R55	0698-7245	1	RESISTOR 2.37K 1% .05W F TC=0+-100	24546	C3-1/8-T0-2371-G
A1R56	0757-0317		RESISTOR 1.33K 1% .125W F TC=0+-100	24546	C4-1/8-T0-1331-F
A1R57	0698-0083		RESISTOR 1.96K 1% .125W F TC=0+-100	24546	C4-1/8-T0-1961-F
A1R58	0698-7260		RESISTOR 10K 1% .05W F TC=0+-100	24546	C3-1/8-T0-1002-G
A1R59	0698-7258		RESISTOR 8.25K 1% .05W F TC=0+-100	24546	C3-1/8-T0-8251-G
A1R60	0698-7278	1	RESISTOR 56.2K 1% .05W F TC=0+-100	24546	C3-1/8-T0-5622-G
A1R61	0698-7270		RESISTOR 26.1K 1% .05W F TC=0+-100	24546	C3-1/8-T0-2612-G
A1R62	0698-7236		RESISTOR 1K 1% .05W F TC=0+-100	24546	C3-1/8-T0-1001-G
A1R63	0698-7236		RESISTOR 1K 1% .05W F TC=0+-100	24546	C3-1/8-T0-1001-G
A1R64	0698-7260		RESISTOR 10K 1% .05W F TC=0+-100	24546	C3-1/8-T0-1002-G
A1R65	0698-7260	3	RESISTOR 10K 1% .05W F TC=0+-100	24546	C3-1/8-T0-1002-G
A1R66	0698-7260		RESISTOR 10K 1% .05W F TC=0+-100	24546	C3-1/8-T0-1002-G
A1R67	0757-0419		RESISTOR 681 1% .125W F TC=0+-100	24546	C4-1/8-T0-681R-F
A1R68	0757-0289		RESISTOR 13.3K 1% .125W F TC=0+-100	19701	MF4C1/8-T0-1332-F
A1R69	0757-0428		RESISTOR 1.62K 1% .125W F TC=0+-100	24546	C4-1/8-T0-1621-F
A1R70	0757-1094	4	RESISTOR 1.47K 1% .125W F TC=0+-100	24546	C4-1/8-T0-1471-F
A1R71	0698-7284		RESISTOR 100K 1% .05W F TC=0+-100	24546	C3-1/8-T0-1003-G
A1R72	0757-0288		RESISTOR 9.09K 1% .125W F TC=0+-100	19701	MF4C1/8-T0-9091-F
A1R73	0698-7256		RESISTOR 6.81K 1% .05W F TC=0+-100	24546	C3-1/8-T0-6811-G
A1R74	0698-7264		RESISTOR 14.7K 1% .05W F TC=0+-100	24546	C3-1/8-T0-1472-G
A1R75	0698-7284	1	RESISTOR 100K 1% .05W F TC=0+-100	24546	C3-1/8-T0-1003-G
A1R76	0698-7270		RESISTOR 26.1K 1% .05W F TC=0+-100	24546	C3-1/8-T0-2612-G
A1R77	0698-7264		RESISTOR 14.7K 1% .05W F TC=0+-100	24546	C3-1/8-T0-1472-G
A1R78	0698-7256		RESISTOR 6.81K 1% .05W F TC=0+-100	24546	C3-1/8-T0-6811-G
A1R79	0698-7253		RESISTOR 5.11K 1% .05W F TC=0+-100	24546	C3-1/8-T0-5111-G
A1R80	0698-7236	1	RESISTOR 1K 1% .05W F TC=0+-100	24546	C3-1/8-T0-1001-G
A1R81	0698-7253		RESISTOR 5.11K 1% .05W F TC=0+-100	24546	C3-1/8-T0-5111-G
A1R82	0698-7263		RESISTOR 13.3K 1% .05W F TC=0+-100	24546	C3-1/8-T0-1332-G
A1R83	0698-7276		RESISTOR 46.4K 1% .05W F TC=0+-100	24546	C3-1/8-T0-4642-G
A1R84	0698-7243		RESISTOR 1.96K 1% .05W F TC=0+-100	24546	C3-1/8-T0-1961-G
A1U1	1813-0041	1	IC LM 0042C OP AMP	27014	LM0042CH
A1U2	1826-0092		IC MC 1458 OP AMP	28480	1826-0092
A1U3	1820-0076		IC-DIGITAL SN7476N TTL DUAL J-K	01295	SN7476N
A1U4	1200-0507		SOCKET-IC 16-CONT DIP-SLDR-TERMS	06776	ICN-163-S3W
A1U5	1826-0092	2	IC MC 1458 OP AMP	28480	1826-0092
A1U6	1820-0054		IC-DIGITAL SN7400N TTL QUAD 2 NAND	01295	SN7400N
A1U7	1200-0508	12	SOCKET-IC 14-CONT DIP-SLDR-TERMS	06776	ICN-143-S3W
A1U7	1820-0411		IC-DIGITAL MC817P TTL QUAD 2 NOR	04713	MC817P
A1U7	1200-0508	1	SOCKET-IC 14-CONT DIP-SLDR-TERMS	06776	ICN-143-S3W

See introduction to this section for ordering information

Table 6-2. Replaceable Parts

Reference Designation	HP Part Number	Qty	Description	Mfr Code	Mfr Part Number
A1U8	1821-0001 1200-0506	2	TRANSISTOR ARRAY DIP SOCKET-IC 14-CONT DIP-SLDR-TERMS	02735 06776	CA3046 ICN-143-S3W
A1U9	1820-0054 1200-0506		IC-DIGITAL SN7400N TTL QUAD 2 NAND SOCKET-IC 14-CONT DIP-SLDR-TERMS	01295 06776	SN7400N ICN-143-S3W
A1U10	1820-0579 1200-0507	1	IC-DIGITAL SN74123N TTL DUAL SOCKET-IC 16-CONT DIP-SLDR-TERMS	01295 06776	SN74123N ICN-163-S3W
A1U11	1826-0092		IC MC 1458 OP AMP	28480	1826-0092
A1VR1	1902-3002	1	DIODE-ZNR 2.37V 5% DO-7 PD=.4W TC=-.074%	15818	CD 35526
A1VR2	1902-0025	1	DIODE-ZNR 10V 5% DO-7 PD=.4W TC=+.06%	28480	1902-0025
A1VR3	1902-3082	4	DIODE-ZNR 4.64V 5% DO-7 PD=.4W TC=-.023%	15818	CD 35610
A1VR4	1902-3082		DIODE-ZNR 4.64V 5% DO-7 PD=.4W TC=-.023%	15818	CD 35610
A1VR5	1902-3203	1	DIODE-ZNR 14.7V 5% DO-7 PD=.4W TC=+.057%	28480	1902-3203
A1VR6	1902-0041	2	DIODE-ZNR 5.11V 5% DO-7 PD=.4W TC=-.009%	15818	CD 35622
			A1 MISCELLANEOUS		
	1251-0600	48	CONTACT-CONN U/W-POST-TYPE MALE DP-SLDR	28480	1251-0600
	8159-0005	3	WIRE 22AWG W PVC 1X22 80C	28480	8159-0005
A2	08620-60112	1	BOARD ASSEMBLY, FREQUENCY CONTROL	28480	08620-60112
A2C1	0160-1706	1	CAPACITOR-FXD 100UF+-20% 25VDC TA	56289	109D107X0025F2
A2C2	0160-1746	1	CAPACITOR-FXD 15UF+-10% 20VDC TA	56289	150D150X9020B2
A2C3	0160-0573	3	CAPACITOR-FXD 4700PF +-20% 100WVDC CER	28480	0160-0573
A2C4	0160-0573	1	CAPACITOR-FXD 4700PF +-20% 100WVDC CER	28480	0160-0573
A2K1	0490-0916	3	RELAY-REED 1A .5A 50V CONT 5V-COIL	28480	0490-0916
A2K2	0490-0916		RELAY-REED 1A .5A 50V CONT 5V-COIL	28480	0490-0916
A2K3	0490-0916		RELAY-REED 1A .5A 50V CONT 5V-COIL	28480	0490-0916
A2K4	0490-1013	8	RELAY-REED 1C 250MA 28VAC 5VDC-COIL 3VA	28480	0490-1013
A2K5	0490-1013		RELAY-REED 1C 250MA 28VAC 5VDC-COIL 3VA	28480	0490-1013
A2K6	0490-1013		RELAY-REED 1C 250MA 28VAC 5VDC-COIL 3VA	28480	0490-1013
A2K7	0490-1013		RELAY-REED 1C 250MA 28VAC 5VDC-COIL 3VA	28480	0490-1013
A2K8	0490-1013		RELAY-REED 1C 250MA 28VAC 5VDC-COIL 3VA	28480	0490-1013
A2K9	0490-1013		RELAY-REED 1C 250MA 28VAC 5VDC-COIL 3VA	28480	0490-1013
A2K10	0490-1013		RELAY-REED 1C 250MA 28VAC 5VDC-COIL 3VA	28480	0490-1013
A2L1	9140-0137	2	COIL-MLD 1MH 5% Q=60 .190X.44LG SRF=3MHZ	99800	2500-28
A2MP1	4040-0750	2	EXTRACTOR-PC BD RED POLYC .062-BD-TMKNS	28480	4040-0750
A2MP2	4040-0750		EXTRACTOR-PC BD RED POLYC .062-BD-TMKNS	28480	4040-0750
A2MP3	1480-0073		PIN:DRIVE 0.250" LG	00000	08D
A2MP4	1480-0073		PIN:DRIVE 0.250" LG	00000	08D
A2Q1	1855-0020	5	TRANSISTOR J-FET N-CHAN D-MODE TO-18 SI	28480	1855-0020
A2Q2	1854-0404		TRANSISTOR NPN SI TO-18 PD=360MW	28480	1854-0404
A2Q3	1854-0404		TRANSISTOR NPN SI TO-18 PD=360MW	28480	1854-0404
A2Q4	1854-0404		TRANSISTOR NPN SI TO-18 PD=360MW	28480	1854-0404
A2Q5	1854-0404		TRANSISTOR NPN SI TO-18 PD=360MW	28480	1854-0404
A2Q6	1855-0020		TRANSISTOR J-FET N-CHAN D-MODE TO-18 SI	28480	1855-0020
A2Q7	1855-0020		TRANSISTOR J-FET N-CHAN D-MODE TO-18 SI	28480	1855-0020
A2Q8	1855-0020		TRANSISTOR J-FET N-CHAN D-MODE TO-18 SI	28480	1855-0020
A2R1	0698-3449	7	RESISTOR 28.7K 1% .125W F TC=0+-100	24546	C4-1/8-T0-2872-F
A2R2	0698-3159	6	RESISTOR 26.1K 1% .125W F TC=0+-100	24546	C4-1/8-T0-2612-F
A2R3	0757-0461		RESISTOR 68.1K 1% .125W F TC=0+-100	24546	C4-1/8-T0-6812-F
A2R4	0698-3449		RESISTOR 28.7K 1% .125W F TC=0+-100	24546	C4-1/8-T0-2872-F
A2R5	0698-3159		RESISTOR 26.1K 1% .125W F TC=0+-100	24546	C4-1/8-T0-2612-F
A2R6	0757-0461		RESISTOR 68.1K 1% .125W F TC=0+-100	24546	C4-1/8-T0-6812-F
A2R7	0698-3449		RESISTOR 28.7K 1% .125W F TC=0+-100	24546	C4-1/8-T0-2872-F
A2R8	0698-3159		RESISTOR 26.1K 1% .125W F TC=0+-100	24546	C4-1/8-T0-2612-F
A2R9	0757-0461		RESISTOR 68.1K 1% .125W F TC=0+-100	24546	C4-1/8-T0-6812-F
A2R10	0698-3260		RESISTOR 464K 1% .125W F TC=0+-100	91637	CMF-55-1, T-1
A2R11	0698-3260		RESISTOR 464K 1% .125W F TC=0+-100	91637	CMF-55-1, T-1
A2R12	0698-3449		RESISTOR 28.7K 1% .125W F TC=0+-100	24546	C4-1/8-T0-2872-F
A2R13	0698-3260		RESISTOR 464K 1% .125W F TC=0+-100	91637	CMF-55-1, T-1
A2R14	0698-3260		RESISTOR 464K 1% .125W F TC=0+-100	91637	CMF-55-1, T-1
A2R15	0757-0465	4	RESISTOR 100K 1% .125W F TC=0+-100	24546	C4-1/8-T0-1003-F
A2R16	0698-3260		RESISTOR 464K 1% .125W F TC=0+-100	91637	CMF-55-1, T-1
A2R17	0698-3159		RESISTOR 26.1K 1% .125W F TC=0+-100	24546	C4-1/8-T0-2612-F
A2R18	0757-0461		RESISTOR 68.1K 1% .125W F TC=0+-100	24546	C4-1/8-T0-6812-F
A2R19	0757-0462	1	RESISTOR 75K 1% .125W F TC=0+-100	24546	C4-1/8-T0-7502-F
A2R20	0698-3162	1	RESISTOR 46.4K 1% .125W F TC=0+-100	24546	C4-1/8-T0-4642-F
A2R21	2100-3103	12	RESISTOR-TRMR 10K 10% C SIDE-ADJ 17-TRN	32997	3006P-1-103
A2R22	2100-3103		RESISTOR-TRMR 10K 10% C SIDE-ADJ 17-TRN	32997	3006P-1-103
A2R23	0698-3260		RESISTOR 464K 1% .125W F TC=0+-100	91637	CMF-55-1, T-1
A2R24	0811-1185	1	RESISTOR 10K .01% .0125W PWH TC=0+-10	20940	140-1/20-1002-T
A2R25	2100-3154	9	RESISTOR-TRMR 1K 10% C SIDE-ADJ 17-TRN	32997	3006P-1-102

See introduction to this section for ordering information

Table 6-2. Replaceable Parts

Reference Designation	HP Part Number	Qty	Description	Mfr Code	Mfr Part Number
A2R26	2100-3154		RESISTOR-TRMR 1K 10% C SIDE-ADJ 17-TRN	32997	3006P-1-102
A2R27	2100-3154		RESISTOR-TRMR 1K 10% C SIDE-ADJ 17-TRN	32997	3006P-1-102
A2R28	0811-1186	1	RESISTOR 20K .01% .0125W PWW TC=0+-10	20940	140-1/80-2002-T
A2R29	2100-3123	1	RESISTOR-TRMR 500 10% C SIDE-ADJ 17-TRN	32997	3006P-1-501
A2R30	0698-8045	5	RESISTOR 9.5K 1% .125W F TC=0+-25	19701	MF4C1/8-T9-9501-F
A2R31	0698-8045		RESISTOR 9.5K 1% .125W F TC=0+-25	19701	MF4C1/8-T9-9501-F
A2R32	0698-8045		RESISTOR 9.5K 1% .125W F TC=0+-25	19701	MF4C1/8-T9-9501-F
A2R33	2100-3095	3	RESISTOR-TRMR 200 10% C SIDE-ADJ 17-TRN	32997	3006P-1-201
A2R34	0811-1197	1	RESISTOR 1.78K 1% .125W PWW TC=0+-10	20940	114-1/8-1781-F
A2R35	2100-3154		RESISTOR-TRMR 1K 10% C SIDE-ADJ 17-TRN	32997	3006P-1-102
A2R36	2100-3154		RESISTOR-TRMR 1K 10% C SIDE-ADJ 17-TRN	32997	3006P-1-102
A2R37	0698-8025	1	RESISTOR 1.91K .25% .125W F TC=0+-50	19701	MF4C1/8-T2-1911-C
A2R38	0811-2870	1	RESISTOR 1.96K 1% .05W PWW TC=0+-10	14140	1409-1/20-D-1961-F
A2R39	0698-8045		RESISTOR 9.5K 1% .125W F TC=0+-25	19701	MF4C1/8-T9-9501-F
A2R40	0698-8045		RESISTOR 9.5K 1% .125W F TC=0+-25	19701	MF4C1/8-T9-9501-F
A2R41	2100-3103		RESISTOR-TRMR 10K 10% C SIDE-ADJ 17-TRN	32997	3006P-1-103
A2R42	2100-3122	2	RESISTOR-TRMR 100 10% C TOP-ADJ 15-TRN	32997	3006P-1-101
A2R43	2100-3103		RESISTOR-TRMR 10K 10% C SIDE-ADJ 17-TRN	32997	3006P-1-103
A2R44	2100-3103		RESISTOR-TRMR 10K 10% C SIDE-ADJ 17-TRN	32997	3006P-1-103
A2R45	0757-0418	1	RESISTOR 619 1% .125W F TC=0+-100	24546	C4-1/8-T0-619R-F
A2R46	2100-3103		RESISTOR-TRMR 10K 10% C SIDE-ADJ 17-TRN	32997	3006P-1-103
A2R47	0811-1196	5	RESISTOR 5K .1% .062W PWW TC=0+-10	20940	114-1/16-5001-B
A2R48	0811-1196		RESISTOR 5K .1% .062W PWW TC=0+-10	20940	114-1/16-5001-B
A2R49	2100-3103		RESISTOR-TRMR 10K 10% C SIDE-ADJ 17-TRN	32997	3006P-1-103
A2R50	2100-3103		RESISTOR-TRMR 10K 10% C SIDE-ADJ 17-TRN	32997	3006P-1-103
A2R51	0698-3260		RESISTOR 464K 1% .125W F TC=0+-100	91637	CMF-55-1, T-1
A2R52	0698-3260		RESISTOR 464K 1% .125W F TC=0+-100	91637	CMF-55-1, T-1
A2R53	0811-1196		RESISTOR 5K .1% .062W PWW TC=0+-10	20940	114-1/16-5001-B
A2R54	0811-1196		RESISTOR 5K .1% .062W PWW TC=0+-10	20940	114-1/16-5001-B
A2R55	2100-3103		RESISTOR-TRMR 10K 10% C SIDE-ADJ 17-TRN	32997	3006P-1-103
A2R56	0757-0461		RESISTOR 68.1K 1% .125W F TC=0+-100	24546	C4-1/8-T0-6812-F
A2R57	2100-3095		RESISTOR-TRMR 200 10% C SIDE-ADJ 17-TRN	32997	3006P-1-201
A2R58	0698-3446	1	RESISTOR 383 1% .125W F TC=0+-100	24546	C4-1/8-T0-383R-F
A2U1	1826-0261	10	IC UA 741 OP AMP	28480	1826-0261
A2U2	1826-0261		IC UA 741 OP AMP	28480	1826-0261
A2U3	1826-0261		IC UA 741 OP AMP	28480	1826-0261
A2U4	1826-0261		IC UA 741 OP AMP	28480	1826-0261
A2U5	1826-0261		IC UA 741 OP AMP	28480	1826-0261
A2U6	1826-0261		IC UA 741 OP AMP	28480	1826-0261
A2U7	1826-0261		IC UA 741 OP AMP	28480	1826-0261
A2U8	1820-1197	6	IC-DIGITAL SN74LS00N TTL LS QUAD 2 NAND	01295	SN74LS00N
	1200-0508		SOCKET-IC 14-CONT DIP-SLDR-TERMS	06776	ICN-143-83W
A2VR1	1902-3082		DIODE-ZNR 4.64V 5% DO-7 PD=.4W TC=-.023%	15818	CD 35610
			A2 MISCELLANEOUS		
	1251-0600		CONTACT-CONN U/W-POST-TYPE MALE DPSLDR	28480	1251-0600
A3	08620-60113	1	BOARD ASSEMBLY, LOGIC	28480	08620-60113
A3C1	0160-4084	2	CAPACITOR-FXD .1UF +-20% 50WVDC CER	28480	0160-4084
A3C2	0160-4084		CAPACITOR-FXD .1UF +-20% 50WVDC CER	28480	0160-4084
A3C3	0180-2206	2	CAPACITOR-FXD 60UF+-10% 6VDC TA	56289	150D06X900682
A3C4	0160-0573		CAPACITOR-FXD 4700PF +-20% 100WVDC CER	28480	0160-0573
A3C5	0160-0575	5	CAPACITOR-FXD .047UF +-20% 50WVDC CER	28480	0160-0575
A3C6	0160-3878		CAPACITOR-FXD 1000PF +-20% 100WVDC CER	28480	0160-3878
A3C7	0160-3878		CAPACITOR-FXD 1000PF +-20% 100WVDC CER	28480	0160-3878
A3C8	0160-3878		CAPACITOR-FXD 1000PF +-20% 100WVDC CER	28480	0160-3878
A3C9	0160-0575		CAPACITOR-FXD .047UF +-20% 50WVDC CER	28480	0160-0575
A3C10	0160-0575		CAPACITOR-FXD .047UF +-20% 50WVDC CER	28480	0160-0575
A3C11	0160-0575		CAPACITOR-FXD .047UF +-20% 50WVDC CER	28480	0160-0575
A3C12	0160-3878		CAPACITOR-FXD 1000PF +-20% 100WVDC CER	28480	0160-3878
A3CR1	1901-0050	21	DIODE-SWITCHING 80V 200MA 2NS DO-7	28480	1901-0050
A3CR2	1901-0050		DIODE-SWITCHING 80V 200MA 2NS DO-7	28480	1901-0050
A3CR3	1901-0050		DIODE-SWITCHING 80V 200MA 2NS DO-7	28480	1901-0050
A3CR4	1901-0050		DIODE-SWITCHING 80V 200MA 2NS DO-7	28480	1901-0050
A3CR5	1901-0050		DIODE-SWITCHING 80V 200MA 2NS DO-7	28480	1901-0050
A3K1	0490-1013		RELAY-REED 1C 250MA 28VAC 5VDC-COIL 3VA	28480	0490-1013
A3MP1	4040-0751	2	EXTRACTOR-PC 8D GRN POLYC .062-8D-THKNS	28480	4040-0751
A3MP2	4040-0751		EXTRACTOR-PC 8D GRN POLYC .062-8D-THKNS	28480	4040-0751
A3MP3	1480-0073		PIN:DRIVE 0.250" LG	00000	08D
A3MP4	1480-0073		PIN:DRIVE 0.250" LG	00000	08D
A3Q1	1854-0404		TRANSISTOR NPN SI TO-18 PD=360MW	28480	1854-0404
A3Q2	1854-0404		TRANSISTOR NPN SI TO-18 PD=360MW	28480	1854-0404
A3Q3	1854-0404		TRANSISTOR NPN SI TO-18 PD=360MW	28480	1854-0404
A3Q4	1854-0404		TRANSISTOR NPN SI TO-18 PD=360MW	28480	1854-0404
A3Q5	1854-0404		TRANSISTOR NPN SI TO-18 PD=360MW	28480	1854-0404

See introduction to this section for ordering information

Table 6-2. Replaceable Parts

Reference Designation	HP Part Number	Qty	Description	Mfr Code	Mfr Part Number
A3Q6	1853-0020	5	TRANSISTOR PNP SI PD=300MW FT=150MHZ	28480	1853-0020
A3Q7	1854-0404		TRANSISTOR NPN SI TO-18 PD=360MW	28480	1854-0404
A3Q8	1854-0404		TRANSISTOR NPN SI TO-18 PD=360MW	28480	1854-0404
A3Q9	1854-0404		TRANSISTOR NPN SI TO-18 PD=360MW	28480	1854-0404
A3Q10	1854-0404		TRANSISTOR NPN SI TO-18 PD=360MW	28480	1854-0404
A3Q11	1853-0020	5	TRANSISTOR PNP SI PD=300MW FT=150MHZ	28480	1853-0020
A3Q12	1854-0404		TRANSISTOR NPN SI TO-18 PD=360MW	28480	1854-0404
A3Q13	1854-0404		TRANSISTOR NPN SI TO-18 PD=360MW	28480	1854-0404
A3Q14	1854-0404		TRANSISTOR NPN SI TO-18 PD=360MW	28480	1854-0404
A3Q15	1854-0404		TRANSISTOR NPN SI TO-18 PD=360MW	28480	1854-0404
A3Q16	1854-0404	5	TRANSISTOR NPN SI TO-18 PD=360MW	28480	1854-0404
A3Q17	1854-0404		TRANSISTOR NPN SI TO-18 PD=360MW	28480	1854-0404
A3Q18	1855-0020		TRANSISTOR J-FET N-CHAN D-MODE TO-18 SI	28480	1855-0020
A3K1	0757-0394	7	RESISTOR 51.1K 1% .125W F TC=0+-100	24546	C4-1/8-T0-51R1-F
A3K2	0698-7260		RESISTOR 10K 1% .05W F TC=0+-100	24546	C3-1/8-T0-1002-G
A3K3	0698-7260		RESISTOR 10K 1% .05W F TC=0+-100	24546	C3-1/8-T0-1002-G
A3K4	0698-7260		RESISTOR 10K 1% .05W F TC=0+-100	24546	C3-1/8-T0-1002-G
A3K5	0757-0422		RESISTOR 909 1% .125W F TC=0+-100	24546	C4-1/8-T0-909R-F
A3R6	0757-0442	27	RESISTOR 10K 1% .125W F TC=0+-100	24546	C4-1/8-T0-1002-F
A3R7	0757-0442		RESISTOR 10K 1% .125W F TC=0+-100	24546	C4-1/8-T0-1002-F
A3R8	0757-0442		RESISTOR 10K 1% .125W F TC=0+-100	24546	C4-1/8-T0-1002-F
A3R9	0698-3449		RESISTOR 29.7K 1% .125W F TC=0+-100	24546	C4-1/8-T0-2872-F
A3R10	0698-3159		RESISTOR 26.1K 1% .125W F TC=0+-100	24546	C4-1/8-T0-2612-F
A3R11	0757-0461		RESISTOR 68.1K 1% .125W F TC=0+-100	24546	C4-1/8-T0-6812-F
A3R12	0698-3449		RESISTOR 28.7K 1% .125W F TC=0+-100	24546	C4-1/8-T0-2872-F
A3R13	0698-3159		RESISTOR 26.1K 1% .125W F TC=0+-100	24546	C4-1/8-T0-2612-F
A3R14	0757-0461		RESISTOR 68.1K 1% .125W F TC=0+-100	24546	C4-1/8-T0-6812-F
A3R15	0698-3260		RESISTOR 464K 1% .125W F TC=0+-100	91637	CMF=55-1, T=1
A3R16	0757-0459	1	RESISTOR 56.2K 1% .125W F TC=0+-100	24546	C4-1/8-T0-5622-F
A3R17	0698-3429		RESISTOR 19.6K 1% .125W F TC=0+-100	03888	PME55-1/8-T0-19R6-F
A3R18	0698-3429		RESISTOR 19.6K 1% .125W F TC=0+-100	03888	PME55-1/8-T0-19R6-F
A3R19	0698-3429		RESISTOR 19.6K 1% .125W F TC=0+-100	03888	PME55-1/8-T0-19R6-F
A3R20	0698-3260		RESISTOR 464K 1% .125W F TC=0+-100	91637	CMF=55-1, T=1
A3R21	0757-0416	3	RESISTOR 511 1% .125W F TC=0+-100	24546	C4-1/8-T0-511R-F
A3R22	0698-0085		RESISTOR 2.61K 1% .125W F TC=0+-100	24546	C4-1/8-T0-2611-F
A3R23	0757-0416		RESISTOR 511 1% .125W F TC=0+-100	24546	C4-1/8-T0-511R-F
A3R24	0757-0442		RESISTOR 10K 1% .125W F TC=0+-100	24546	C4-1/8-T0-1002-F
A3R25	0757-0442		RESISTOR 10K 1% .125W F TC=0+-100	24546	C4-1/8-T0-1002-F
A3R26	0757-0442	9	RESISTOR 10K 1% .125W F TC=0+-100	24546	C4-1/8-T0-1002-F
A3R27	0698-3157		RESISTOR 19.6K 1% .125W F TC=0+-100	24546	C4-1/8-T0-1962-F
A3R28	0698-3157		RESISTOR 19.6K 1% .125W F TC=0+-100	24546	C4-1/8-T0-1962-F
A3R29	0698-3157		RESISTOR 19.6K 1% .125W F TC=0+-100	24546	C4-1/8-T0-1962-F
A3R30	0698-0085		RESISTOR 2.61K 1% .125W F TC=0+-100	24546	C4-1/8-T0-2611-F
A3R31	0698-0085	3	RESISTOR 2.61K 1% .125W F TC=0+-100	24546	C4-1/8-T0-2611-F
A3R32	0698-0085		RESISTOR 2.61K 1% .125W F TC=0+-100	24546	C4-1/8-T0-2611-F
A3R33	0698-0085		RESISTOR 2.61K 1% .125W F TC=0+-100	24546	C4-1/8-T0-2611-F
A3R34	0698-3157		RESISTOR 19.6K 1% .125W F TC=0+-100	24546	C4-1/8-T0-1962-F
A3R35	0757-0442		RESISTOR 10K 1% .125W F TC=0+-100	24546	C4-1/8-T0-1002-F
A3R36	0757-0442	2	RESISTOR 10K 1% .125W F TC=0+-100	24546	C4-1/8-T0-1002-F
A3R37	0757-0439		RESISTOR 6.81K 1% .125W F TC=0+-100	24546	C4-1/8-T0-6811-F
A3R38	0757-0441	3	RESISTOR 8.25K 1% .125W F TC=0+-100	24546	C4-1/8-T0-8251-F
A3R39	0757-0441		RESISTOR 8.25K 1% .125W F TC=0+-100	24546	C4-1/8-T0-8251-F
A3R40	0757-0436	7	RESISTOR 5.11K 1% .125W F TC=0+-100	24546	C4-1/8-T0-5111-F
A3R41	0757-0422		RESISTOR 909 1% .125W F TC=0+-100	24546	C4-1/8-T0-909R-F
A3R42	0757-0442	3	RESISTOR 10K 1% .125W F TC=0+-100	24546	C4-1/8-T0-1002-F
A3R43	0698-0085		RESISTOR 2.61K 1% .125W F TC=0+-100	24546	C4-1/8-T0-2611-F
A3R44	0698-0085		RESISTOR 2.61K 1% .125W F TC=0+-100	24546	C4-1/8-T0-2611-F
A3R45	0757-0442		RESISTOR 10K 1% .125W F TC=0+-100	24546	C4-1/8-T0-1002-F
A3R46	0698-3157		RESISTOR 19.6K 1% .125W F TC=0+-100	24546	C4-1/8-T0-1962-F
A3R47	0757-0442	3	RESISTOR 10K 1% .125W F TC=0+-100	24546	C4-1/8-T0-1002-F
A3R48	0698-3157		RESISTOR 19.6K 1% .125W F TC=0+-100	24546	C4-1/8-T0-1962-F
A3R49	0757-0442		RESISTOR 10K 1% .125W F TC=0+-100	24546	C4-1/8-T0-1002-F
A3R50	0757-0442		RESISTOR 10K 1% .125W F TC=0+-100	24546	C4-1/8-T0-1002-F
A3R51	0757-0442		RESISTOR 10K 1% .125W F TC=0+-100	24546	C4-1/8-T0-1002-F
A3R52	0698-0085	3	RESISTOR 2.61K 1% .125W F TC=0+-100	24546	C4-1/8-T0-2611-F
A3R53	0698-0085		RESISTOR 2.61K 1% .125W F TC=0+-100	24546	C4-1/8-T0-2611-F
A3R54	0698-3157		RESISTOR 19.6K 1% .125W F TC=0+-100	24546	C4-1/8-T0-1962-F
A3R55	0698-0085		RESISTOR 2.61K 1% .125W F TC=0+-100	24546	C4-1/8-T0-2611-F
A3R56	0757-0442		RESISTOR 10K 1% .125W F TC=0+-100	24546	C4-1/8-T0-1002-F
A3R57	0698-3152	3	RESISTOR 3.48K 1% .125W F TC=0+-100	24546	C4-1/8-T0-3481-F
A3R58	0698-0085		RESISTOR 2.61K 1% .125W F TC=0+-100	24546	C4-1/8-T0-2611-F
A3R59	0698-0085		RESISTOR 2.61K 1% .125W F TC=0+-100	24546	C4-1/8-T0-2611-F
A3R60	0757-0422		RESISTOR 909 1% .125W F TC=0+-100	24546	C4-1/8-T0-909R-F
A3R61	0698-3157		RESISTOR 19.6K 1% .125W F TC=0+-100	24546	C4-1/8-T0-1962-F
A3R62	0757-0442	RESISTOR 10K 1% .125W F TC=0+-100	24546	C4-1/8-T0-1002-F	

See introduction to this section for ordering information

Table 6-2. Replaceable Parts

Reference Designation	HP Part Number	Qty	Description	Mfr Code	Mfr Part Number
A3U1	1820-1201 1200-0508	3	IC-DIGITAL SN74LS08N TTL LS QUAD 2 AND SOCKET-IC 14-CONT DIP-SLDR-TERMS	01295 06776	SN74LS08N ICN-143-83W
A3U2	1826-0026	6	IC LM 311 COMPARATOR	27014	LM311H
A3U3	1826-0026		IC LM 311 COMPARATOR	27014	LM311H
A3U4	1826-0026		IC LM 311 COMPARATOR	27014	LM311H
A3U5	1820-0282 1200-0508	1	IC-DIGITAL SN7486N TTL QUAD 2 EXCL-OR SOCKET-IC 14-CONT DIP-SLDR-TERMS	01295 06776	SN7486N ICN-143-83W
A3U6	1820-1212 1200-0507	3	IC-DIGITAL SN74LS112N TTL LS DUAL SOCKET-IC 16-CONT DIP-SLDR-TERMS	01295 06776	SN74LS112N ICN-163-83W
A3U7	1820-1212 1200-0507		IC-DIGITAL SN74LS112N TTL LS DUAL SOCKET-IC 16-CONT DIP-SLDR-TERMS	01295 06776	SN74LS112N ICN-163-83W
A3U8	1826-0026		IC LM 311 COMPARATOR	27014	LM311H
A3U9	1826-0026		IC LM 311 COMPARATOR	27014	LM311H
A3U10	1826-0026		IC LM 311 COMPARATOR	27014	LM311H
A3U11	1820-1416 1200-0508	1	IC-DIGITAL SN74LS14N TTL LS HEX 1 INV SOCKET-IC 14-CONT DIP-SLDR-TERMS	01295 06776	SN74LS14N ICN-143-83W
A3U12	1820-1197 1200-0508		IC-DIGITAL SN74LS00N TTL LS QUAD 2 NAND SOCKET-IC 14-CONT DIP-SLDR-TERMS	01295 06776	SN74LS00N ICN-143-83W
A3U13	1820-1197 1200-0508		IC-DIGITAL SN74LS00N TTL LS QUAD 2 NAND SOCKET-IC 14-CONT DIP-SLDR-TERMS	01295 06776	SN74LS00N ICN-143-83W
A3V81	1902-0184	3	DIODE-ZNR 16.2V 5% DO-7 PD=.4W TC=+.066X	04713	SZ 10939-242
A4	08620-60114	1	BOARD ASSEMBLY, +5V20 REGULATOR	28480	08620-60114
A4C1	0160-0158	1	CAPACITOR-FXD 5600PF +-10% 200WVDC POLYE	56289	292P56292
A4C2	0180-0235	3	CAPACITOR-FXD 56UF+-20% 75VDC TA	56289	109D566X0075T2
A4C3	0180-2486	1	CAPACITOR-FXD 470UF+-20% 30VDC TA	56289	109D477X0030T2
A4C4	0160-0301	2	CAPACITOR-FXD .012UF +-10% 200WVDC POLYE	56289	292P12392
A4C5	0180-2206	3	CAPACITOR-FXD 220UF+-10% 10VDC TA	56289	150D227X9010S2
A4CR1	1901-0050		DIODE-SWITCHING 80V 200MA 2NS DO-7	28480	1901-0050
A4CR2	1901-0050		DIODE-SWITCHING 80V 200MA 2NS DO-7	28480	1901-0050
A4CR3	1901-0050		DIODE-SWITCHING 80V 200MA 2NS DO-7	28480	1901-0050
A4CR4	1901-0159		DIODE-PWR RECT 400V 750MA DO-41	04713	SR1358-4
A4CR5	1901-0050		DIODE-SWITCHING 80V 200MA 2NS DO-7	28480	1901-0050
A4CR6	1901-0050		DIODE-SWITCHING 80V 200MA 2NS DO-7	28480	1901-0050
A4CR7	1901-0050		DIODE-SWITCHING 80V 200MA 2NS DO-7	28480	1901-0050
A4CR8	1901-0159		DIODE-PWR RECT 400V 750MA DO-41	04713	SR1358-4
A4CR9	1901-0050		DIODE-SWITCHING 80V 200MA 2NS DO-7	28480	1901-0050
A4CR10	1901-0050		DIODE-SWITCHING 80V 200MA 2NS DO-7	28480	1901-0050
A4CR11	1901-0159		DIODE-PWR RECT 400V 750MA DO-41	04713	SR1358-4
A4F1	2110-0332	5	FUSE 3A 125V NORM-BLO .25X.27	71400	6MW 3
A4F2	2110-0332		FUSE 3A 125V NORM-BLO .25X.27	71400	6MW 3
A4MP1	4040-0752	2	EXTR-PC BD YEL POLYC .062-BD-TMKNS	28480	4040-0752
A4MP2	4040-0752		EXTR-PC BD YEL POLYC .062-BD-TMKNS	28480	4040-0752
A4MP3	1460-0073		PIN:DRIVE 0.250" LG	00000	08D
A4MP4	1460-0073		PIN:DRIVE 0.250" LG	00000	08D
A4Q1	1854-0404		TRANSISTOR NPN SI TO-18 PD=360MW	28480	1854-0404
A4Q2	1854-0071	5	TRANSISTOR NPN SI PD=300MW FT=200MHZ	28480	1854-0071
A4Q3	1854-0039	1	TRANSISTOR NPN 2N3053 SI TO-5 PD=1W	04713	2N3053
A4Q4	1853-0020		TRANSISTOR PNP SI PD=300MW FT=150MHZ	28480	1853-0020
A4Q5	1853-0038	3	TRANSISTOR PNP SI TO-39 PD=1W FT=100MHZ	28480	1853-0038
A4Q6	1884-0012	5	THYRISTOR-SCR JEDEC 2N3528	02735	2N3528
A4Q7	1884-0012		THYRISTOR-SCR JEDEC 2N3528	02735	2N3528
A4R1	0812-0014	1	RESISTOR .5 3X 5W PW TC=0+-90	01686	T5
A4R2	0698-0089	2	RESISTOR 1.78K 1% .5W F TC=0+-100	91637	MFF-1/2-10
A4R3	0698-3150	3	RESISTOR 2.37K 1% .125W F TC=0+-100	24546	C4-1/8-T0-2371-F
A4R4	0698-8473	1	RESISTOR 3.358K .1% .1W F TC=0+-5	07716	MAK5, T-16
A4R5	2100-3154		RESISTOR-TRMP 1K 10% C SIDE-ADJ 17-TRN	32997	3006P-1-102
A4R6	0698-8476	1	RESISTOR 5.315K .1% .1W F TC=0+-5	07716	MAK5, T-16
A4R7	0698-0085		RESISTOR 2.61K 1% .125W F TC=0+-100	24546	C4-1/8-T0-2611-F
A4R8	0757-0419		RESISTOR 681 1% .125W F TC=0+-100	24546	C4-1/8-T0-681R-F
A4R9	0698-3153	1	RESISTOR 3.83K 1% .125W F TC=0+-100	24546	C4-1/8-T0-3831-F
A4R10	0757-0280	5	RESISTOR 1K 1% .125W F TC=0+-100	24546	C4-1/8-T0-1001-F
A4R11	0757-0180	3	RESISTOR 31.6 1% .125W F TC=0+-100	24546	C4, T=0
A4R12	0757-0394		RESISTOR 51.1 1% .125W F TC=0+-100	24546	C4-1/8-T0-511R-F
A4R13	0757-0455		RESISTOR 100K 1% .125W F TC=0+-100	24546	C4-1/8-T0-1003-F
A4R14	0757-0394		RESISTOR 51.1 1% .125W F TC=0+-100	24546	C4-1/8-T0-511R-F
A4R15	0757-0442		RESISTOR 10K 1% .125W F TC=0+-100	24546	C4-1/8-T0-1002-F
A4R16	0698-0082	1	RESISTOR 464 1% .125W F TC=0+-100	24546	C4-1/8-T0-4640-F
A4R17	0757-0278	2	RESISTOR 1.78K 1% .125W F TC=0+-100	24546	C4-1/8-T0-1781-F
A4R18	0811-1651	1	RESISTOR .39 5% 2W PW TC=0+-800	75042	BWH2-39/100-J
A4R19	0757-0458		RESISTOR 5.11K 1% .125W F TC=0+-100	24546	C4-1/8-T0-5111-F
A4R20	0757-0458		RESISTOR 5.11K 1% .125W F TC=0+-100	24546	C4-1/8-T0-5111-F

See introduction to this section for ordering information

Table 6-2. Replaceable Parts

Reference Designation	HP Part Number	Qty	Description	Mfr Code	Mfr Part Number
A4R21	0757-0200	1	RESISTOR 5.62K 1% .125W F TC=0+-100	24546	C4-1/8-T0-5621-F
A4R22	0698-3460	1	RESISTOR 422K 1% .125W F TC=0+-100	91637	CMF=55-1, T=1
A4R23	0698-3454	2	RESISTOR 215K 1% .125W F TC=0+-100	24546	C4-1/8-T0-2153-F
A4R24	0698-3447	5	RESISTOR 422 1% .125W F TC=0+-100	24546	C4-1/8-T0-422R-F
A4R25	0757-0397	5	RESISTOR 68.1 1% .125W F TC=0+-100	24546	C4-1/8-T0-68R1-F
A4R26	0757-0447	1	RESISTOR 16.2K 1% .125W F TC=0+-100	24546	C4-1/8-T0-1622-F
A4R27	0698-3150		RESISTOR 2.37K 1% .125W F TC=0+-100	24546	C4-1/8-T0-2371-F
A4R28	0757-0466	2	RESISTOR 110K 1% .125W F TC=0+-100	24546	C4-1/8-T0-1103-F
A4R29	0698-3454		RESISTOR 215K 1% .125W F TC=0+-100	24546	C4-1/8-T0-2153-F
A4R30	0757-0466		RESISTOR 110K 1% .125W F TC=0+-100	24546	C4-1/8-T0-1103-F
A4R31	0757-0278		RESISTOR 1.78K 1% .125W F TC=0+-100	24546	C4-1/8-T0-1781-F
A4R32	2100-3095		RESISTOR-TMR 200 10% C SIDE=ADJ 17-TRN	32997	3006P-1-201
A4R33	0698-0983		RESISTOR 1.96K 1% .125W F TC=0+-100	24546	C4-1/8-T0-1961-F
A4R34	0698-3447		RESISTOR 422 1% .125W F TC=0+-100	24546	C4-1/8-T0-422R-F
A4R35	0757-0397		RESISTOR 68.1 1% .125W F TC=0+-100	24546	C4-1/8-T0-68R1-F
A4U1	1821-0001		TRANSISTOR ARRAY DIP	02735	CA3046
A4U2	1826-0261		IC UA 741 OP AMP	28480	1826-0261
A4VR1	1902-3159	4	DIODE-ZNR 8.25V 5% DO-7 PD=.4W TC=+.053%	04713	SZ 10939-158
A4VR2	1902-3159		DIODE-ZNR 8.25V 5% DO-7 PD=.4W TC=+.053%	04713	SZ 10939-158
A4VR3	1902-3224	2	DIODE-ZNR 17.3V 5% DO-7 PD=.4W TC=+.067%	28480	1902-3224
A4VR4	1902-0680	2	DIODE-ZNR 1N827 6.2V 5% DO-7 PD=.25W	03877	1N827
A4VR5	1902-0680		DIODE-ZNR 1N827 6.2V 5% DO-7 PD=.25W	03877	1N827
A4VR6	1902-3182	4	DIODE-ZNR 12.1V 5% DO-7 PD=.4W TC=+.064%	28480	1902-3182
A4VR7	1902-3256	1	DIODE-ZNR 23.7V 5% DO-7 PD=.4W TC=+.076%	04713	SZ 10939-290
A4VR8	1902-3182		DIODE-ZNR 12.1V 5% DO-7 PD=.4W TC=+.064%	28480	1902-3182
A4VR9	1902-0049	1	DIODE-ZNR 6.19V 5% DO-7 PD=.4W TC=+.022%	28480	1902-0049
A4 MISCELLANEOUS					
	1251-0600		CONTACT-CONN U/W-POST-TYPE MALE DPSLDR	28480	1251-0600
	1251-2313	8	CONNECTOR-SGL CONT SKT .04-DIA	00779	3-332070-5
A5	08620-60115	1	BOARD ASSEMBLY, -10-40 REGULATOR	28480	08620-60115
A5C1	0160-0299	1	CAPACITOR-FXD 1800PF +-10% 200VDC POLYE	56289	292P18292
A5C2	0160-0235		CAPACITOR-FXD 56UF+-20% 75VDC TA	56289	109D566X0075T2
A5C3	0160-0235		CAPACITOR-FXD 56UF+-20% 75VDC TA	56289	109D566X0075T2
A5C4	0160-2208		CAPACITOR-FXD 220UF+-10% 10VDC TA	56289	150D227X9010S2
A5C5	0160-2208		CAPACITOR-FXD 220UF+-10% 10VDC TA	56289	150D227X9010S2
A5C6	0160-0153	1	CAPACITOR-FXD 1000PF +-10% 200VDC POLYE	56289	292P10292
A5C7	0160-0301		CAPACITOR-FXD .012UF +-10% 200VDC POLYE	56289	292P12392
A5CR1	1901-0050		DIODE-SWITCHING 80V 200MA 2NS DO-7	28480	1901-0050
A5CR2	1901-0050		DIODE-SWITCHING 80V 200MA 2NS DO-7	28480	1901-0050
A5CR3	1901-0050		DIODE-SWITCHING 80V 200MA 2NS DO-7	28480	1901-0050
A5CR4	1901-0050		DIODE-SWITCHING 80V 200MA 2NS DO-7	28480	1901-0050
A5CR5	1901-0159		DIODE-PWR RECT 400V 750MA DO-41	04713	SR1358-4
A5CR6	1901-0159		DIODE-PWR RECT 400V 750MA DO-41	04713	SR1358-4
A5CR7	1901-0050		DIODE-SWITCHING 80V 200MA 2NS DO-7	28480	1901-0050
A5CR8	1901-0050		DIODE-SWITCHING 80V 200MA 2NS DO-7	28480	1901-0050
A5CR9	1901-0050		DIODE-SWITCHING 80V 200MA 2NS DO-7	28480	1901-0050
A5CR10	1901-0159		DIODE-PWR RECT 400V 750MA DO-41	04713	SR1358-4
A5CR11	1901-0159		DIODE-PWR RECT 400V 750MA DO-41	04713	SR1358-4
A5CR12	1901-0159		DIODE-PWR RECT 400V 750MA DO-41	04713	SR1358-4
ASF1	2110-0332		FUSE 3A 125V NORM-8L0 .25X.27	71400	GMW 3
ASF2	2110-0332		FUSE 3A 125V NORM-8L0 .25X.27	71400	GMW 3
ASMP1	4040-0753	2	EXTRACTOR-PC BD GRN POLYC .062-80-THKNS	28480	4040-0753
ASMP2	4040-0753		EXTRACTOR-PC BD GRN POLYC .062-80-THKNS	28480	4040-0753
ASMP3	1480-0073		PIN-DRIVE 0.250" LG	00000	08D
ASMP4	1480-0073		PIN-DRIVE 0.250" LG	00000	08D
A5Q1	1853-0020		TRANSISTOR PNP SI PD=300MW FT=150MHZ	28480	1853-0020
A5Q2	1853-0020		TRANSISTOR PNP SI PD=300MW FT=150MHZ	28480	1853-0020
A5Q3	1853-0038		TRANSISTOR PNP SI TO-39 PD=1W FT=100MHZ	28480	1853-0038
A5Q4	1854-0071		TRANSISTOR NPN SI PD=300MW FT=200MHZ	28480	1854-0071
A5Q5	1854-0022	1	TRANSISTOR NPN SI TO-39 PD=700MW	07263	317843
A5Q6	1853-0050		TRANSISTOR PNP SI TO-18 PD=360MW	28480	1853-0050
A5Q7	1853-0038		TRANSISTOR PNP SI TO-39 PD=1W FT=100MHZ	28480	1853-0038
A5Q8	1884-0012		THYRISTOR-SCR JEDEC 2N3528	02735	2N3528
A5Q9	1884-0012		THYRISTOR-SCR JEDEC 2N3528	02735	2N3528
A5R1	0811-1665	1	RESISTOR .82 5% 2W PW TC=0+-800	75042	BWH2-82/100-J
A5R2	0698-3150		RESISTOR 2.37K 1% .125W F TC=0+-100	24546	C4-1/8-T0-2371-F
A5R3	0757-0288		RESISTOR 9.09K 1% .125W F TC=0+-100	19701	MFC1/8-T0-9091-F
A5R4	0757-0442		RESISTOR 10K 1% .125W F TC=0+-100	24546	C4-1/8-T0-1002-F
A5R5	0698-0089		RESISTOR 1.78K 1% .5W F TC=0+-100	91637	MFF=1/2-10

See introduction to this section for ordering information

Table 6-2. Replaceable Parts

Reference Designation	HP Part Number	Qty	Description	Mfr Code	Mfr Part Number
A5R6	0698-3406	1	RESISTOR 1.33K 1% .5W F TC=0+-100	91637	MFF-1/2-10
A5R7	0698-0085		RESISTOR 2.61K 1% .125W F TC=0+-100	24546	C4-1/8-T0-2611-F
A5R8	0698-7842	1	RESISTOR, 26.1K OHM	19701	MF4C1/6-T9-2612-B
A5R9	2100-3109		RESISTOR-TRMR 2K 10% C SIDE-ADJ 17-TRN	32997	3006P-1-202
A5R10	0698-6614	1	RESISTOR 7.5K .1% .125W F TC=0+-25	24546	NESS
A5R11	0757-0397		RESISTOR 68.1 1% .125W F TC=0+-100	24546	C4-1/8-T0-68R1-F
A5R12	2100-3122		RESISTOR-TRMR 100 10% C TOP-ADJ 15-TRN	32997	3006P-1-101
A5R13	0757-0422		RESISTOR 909 1% .125W F TC=0+-100	24546	C4-1/8-T0-909R-F
A5R14	0698-3346	1	RESISTOR 4.22K 1% .5W F TC=0+-100	91637	MFF-1/2-10
A5R15	0757-0180		RESISTOR 31.6 1% .125W F TC=0+-100	24546	C4, T=0
A5R16	0757-0180		RESISTOR 31.6 1% .125W F TC=0+-100	24546	C4-1/8-T0-51R1-F
A5R17	0757-0394		RESISTOR 51.1 1% .125W F TC=0+-100	24546	C4-1/8-T0-51R1-F
A5R18	0757-0394		RESISTOR 51.1 1% .125W F TC=0+-100	24546	C4-1/8-T0-51R1-F
A5R19	0757-0465		RESISTOR 100K 1% .125W F TC=0+-100	24546	C4-1/8-T0-1003-F
A5R20	0757-0465		RESISTOR 100K 1% .125W F TC=0+-100	24546	C4-1/8-T0-1003-F
A5R21	0757-0394		RESISTOR 51.1 1% .125W F TC=0+-100	24546	C4-1/8-T0-51R1-F
A5R22	0757-0394		RESISTOR 51.1 1% .125W F TC=0+-100	24546	C4-1/8-T0-51R1-F
A5R23	0698-3157		RESISTOR 19.6K 1% .125W F TC=0+-100	24546	C4-1/8-T0-1962-F
A5R24	0698-3440	1	RESISTOR 196 1% .125W F TC=0+-100	24546	C4-1/8-T0-196R-F
A5R25	0757-0417	1	RESISTOR 562 1% .125W F TC=0+-100	24546	C4-1/8-T0-562R-F
A5R26	0698-3154	3	RESISTOR 4.22K 1% .125W F TC=0+-100	24546	C4-1/8-T0-4221-F
A5R27	0757-0439		RESISTOR 6.81K 1% .125W F TC=0+-100	24546	C4-1/8-T0-6811-F
A5R28	0698-3631	1	RESISTOR 330 5% 2W MO TC=0+-200	11502	RG42
A5R29	0811-1659	1	RESISTOR .27 5% 2W PW TC=0+-800	75042	BWH2-27/100-J
A5R30	0698-3447		RESISTOR 422 1% .125W F TC=0+-100	24546	C4-1/8-T0-422R-F
A5R31	0757-0397		RESISTOR 68.1 1% .125W F TC=0+-100	24546	C4-1/8-T0-68R1-F
A5R32	0698-3447		RESISTOR 422 1% .125W F TC=0+-100	24546	C4-1/8-T0-422R-F
A5R33	0757-0397		RESISTOR 68.1 1% .125W F TC=0+-100	24546	C4-1/8-T0-68R1-F
A5R34	0757-0416		RESISTOR 511 1% .125W F TC=0+-100	24546	C4-1/8-T0-511R-F
A5R35	0698-3447		RESISTOR 422 1% .125W F TC=0+-100	24546	C4-1/8-T0-422R-F
ASU1	1826-0261		IC UA 741 OP AMP	28480	1826-0261
ASU2	1826-0261		IC UA 741 OP AMP	28480	1826-0261
ASVR1	1902-3139		DIODE-ZNR 8.25V 5% DO-7 PD=.4W TC=+.053%	04713	SZ 10939-158
ASVR2	1902-3139		DIODE-ZNR 8.25V 5% DO-7 PD=.4W TC=+.053%	04713	SZ 10939-158
ASVR3	1902-3224		DIODE-ZNR 17.8V 5% DO-7 PD=.4W TC=+.067%	28480	1902-3224
ASVR4	1902-0071	1	DIODE-ZNR 9V 5% DO-14 PD=.5W TC=+.001%	28480	1902-0071
ASVR5	1902-0184		DIODE-ZNR 16.2V 5% DO-7 PD=.4W TC=+.066%	04713	SZ 10939-242
ASVR6	1902-3345	1	DIODE-ZNR 51.1V 5% DO-7 PD=.4W TC=+.081%	04713	SZ 10939-386
ASVR7	1902-3182		DIODE-ZNR 12.1V 5% DO-7 PD=.4W TC=+.064%	28480	1902-3182
A5 MISCELLANEOUS					
	1251-0600		CONTACT-CONN U/W-POST-TYPE MALE DP5LDR	28480	1251-0600
	1251-2313		CONNECTOR-SGL CONT SKT .04-DIA	00779	3-352070-5
A6CR1	1902-3082		DIODE-ZNR 4.64V 5% DO-7 PD=.4W TC=-.023%	15818	CD 35610
A6MP1	4040-0754	2	EXTRACTOR-PC BD BLU POLYC .062-8D-THKNS	28480	4040-0754
A6MP2	4040-0754		EXTRACTOR-PC BD BLU POLYC .062-8D-THKNS	28480	4040-0754
A6MP3	1480-0073		PIN-DRIVE 0.250" LG	00000	080
A6MP4	1480-0073		PIN-DRIVE 0.250" LG	00000	080
A6R1	2100-3094	1	RESISTOR-TRMR 100K 10% C SIDE-ADJ 17-TRN	32997	3006P-1-104
A6R2	2100-3103		RESISTOR-TRMR 10K 10% C SIDE-ADJ 17-TRN	32997	3006P-1-103
A6U1	0960-0447	2	IC-DIGITAL, ANALOG CONVERTER	28480	0960-0447
A6U2	1820-0668	3	IC-DIGITAL SN7407N TTL HEX 1 NON-INV	01295	SN7407N
A6U3	1820-0668		IC-DIGITAL SN7407N TTL HEX 1 NON-INV	01295	SN7407N
A6U4	1820-0668		IC-DIGITAL SN7407N TTL HEX 1 NON-INV	01295	SN7407N
A6 MISCELLANEOUS					
	1251-0600		CONTACT-CONN U/W-POST-TYPE MALE DP5LDR	28480	1251-0600
	1251-1556	54	CONNECTOR-SGL CONT SKT .018-IN=8SC-SZ	28480	1251-1556
A6(OPT.001)	08620-60116	1	BOARD ASSEMBLY, BCD PROGRAMMER	28480	08620-60116
A7	08620-60137	1	BOARD ASSEMBLY, OPERATOR CONTROL	28480	08620-60137
A7C1	0180-1715	1	CAPACITOR-FXD 150UF+-10% 6VDC TA	56289	150D157X9006R2
A7C2	0180-0094	1	CAPACITOR-FXD 100UF+75-10% 25VDC AL	56289	30D107G0250D2
A7C3	0160-2055		CAPACITOR-FXD .01UF +80-20% 100WVDC CER	28480	0160-2055
A7C4	0160-2055		CAPACITOR-FXD .01UF +80-20% 100WVDC CER	28480	0160-2055
A7C5	0160-2055		CAPACITOR-FXD .01UF +80-20% 100WVDC CER	28480	0160-2055
A7C6	0160-2055		CAPACITOR-FXD .01UF +80-20% 100WVDC CER	28480	0160-2055
A7C7	0180-2206		CAPACITOR-FXD 60UF+-10% 6VDC TA	56289	150D60X9006B2
A7C8	0180-0218	2	CAPACITOR-FXD .15UF+-10% 35VDC TA	56289	150D154X9035A2
A7C9	0180-0218		CAPACITOR-FXD .15UF+-10% 35VDC TA	56289	150D154X9035A2
A7C10	0160-2055	1	CAPACITOR-FXD .01UF +80-20% 100WVDC CER	28480	0160-2055
A7C11	0180-0197		CAPACITOR-FXD 2.2UF +-10% 20VDC TA	56289	150D225X9020A2

See introduction to this section for ordering information

Table 6-2. Replaceable Parts

Reference Designation	HP Part Number	Qty	Description	Mfr Code	Mfr Part Number
A7CR1	1901-0033		DIODE-GEN PRP 180V 200MA DO-7	28480	1901-0033
A7CR2	1901-0033		DIODE-GEN PRP 180V 200MA DO-7	28480	1901-0033
A7CR3	1901-0033		DIODE-GEN PRP 180V 200MA DO-7	28480	1901-0033
A7CR4	1901-0033		DIODE-GEN PRP 180V 200MA DO-7	28480	1901-0033
A7CR5	1901-0033		DIODE-GEN PRP 180V 200MA DO-7	28480	1901-0033
A7CR6	1901-0033		DIODE-GEN PRP 180V 200MA DO-7	28480	1901-0033
A7CR7	1901-0033		DIODE-GEN PRP 180V 200MA DO-7	28480	1901-0033
A7CR8	1901-0033		DIODE-GEN PRP 180V 200MA DO-7	28480	1901-0033
A7L1	9140-0137		COIL-MLD 1MH 5X Ø=60 .19DX.44LG SRF=3MHZ	99800	2500-28
A7MP1	4040-0755	2	EXTRACTOR-PC 8D VIO POLYC .062=BD=THKNS	28480	4040-0755
A7MP2	4040-0755		EXTRACTOR-PC 8D VIO POLYC .062=BD=THKNS	28480	4040-0755
A7MP3	1480-0073		PIN+DRIVE 0.250" LG	00000	080
A7MP4	1480-0073		PIN+DRIVE 0.250" LG	00000	080
A7Q1	1854-0062	1	TRANSISTOR NPN 2N1701 SI TO-8 PD=25W	04713	2N3055
A7Q2	1854-0404		TRANSISTOR NPN SI TO-18 PD=360MW	28480	1854-0404
A7Q3	1854-0404		TRANSISTOR NPN SI TO-18 PD=360MW	28480	1854-0404
A7Q4	1854-0404		TRANSISTOR NPN SI TO-18 PD=360MW	28480	1854-0404
A7Q5	1854-0013	4	TRANSISTOR NPN 2N2218A SI TO-5 PD=800MW	04713	2N2218A
A7Q6	1854-0013		TRANSISTOR NPN 2N2218A SI TO-5 PD=800MW	04713	2N2218A
A7Q7	1854-0013		TRANSISTOR NPN 2N2218A SI TO-5 PD=800MW	04713	2N2218A
A7Q8	1854-0013		TRANSISTOR NPN 2N2218A SI TO-5 PD=800MW	04713	2N2218A
A7Q9	1853-0034	5	TRANSISTOR PNP SI TO-18 PD=360MW	28480	1853-0034
A7Q10	1853-0034		TRANSISTOR PNP SI TO-18 PD=360MW	28480	1853-0034
A7Q11	1853-0034		TRANSISTOR PNP SI TO-18 PD=360MW	28480	1853-0034
A7Q12	1853-0034		TRANSISTOR PNP SI TO-18 PD=360MW	28480	1853-0034
A7Q13	1853-0012	2	TRANSISTOR PNP 2N2904A SI TO-5 PD=600MW	01295	2N2904A
A7Q14	1854-0071		TRANSISTOR NPN SI PD=300MW FT=200MHZ	28480	1854-0071
A7Q15	1853-0012		TRANSISTOR PNP 2N2904A SI TO-5 PD=600MW	01295	2N2904A
A7Q16	1854-0071		TRANSISTOR NPN SI PD=300MW FT=200MHZ	28480	1854-0071
A7Q17	1853-0050		TRANSISTOR PNP SI TO-18 PD=360MW	28480	1853-0050
A7Q18	1884-0012		THYRISTOR-SCR JEDEC 2N3528	02735	2N3528
A7Q19	1853-0034		TRANSISTOR PNP SI TO-18 PD=360MW	28480	1853-0034
A7Q20	1854-0404		TRANSISTOR NPN SI TO-18 PD=360MW	28480	1854-0404
A7R1	0757-0442		RESISTOR 10K 1% .125W F TC=0+-100	24546	C4-1/8-T0-1002-F
A7R2	0698-3152	2	RESISTOR 3.48K 1% .125W F TC=0+-100	24546	C4-1/8-T0-3481-F
A7R3	0698-3136		RESISTOR 17.8K 1% .125W F TC=0+-100	24546	C4-1/8-T0-1782-F
A7R4	0757-1094		RESISTOR 1.47K 1% .125W F TC=0+-100	24546	C4-1/8-T0-1471-F
A7R5	0757-0442		RESISTOR 10K 1% .125W F TC=0+-100	24546	C4-1/8-T0-1002-F
A7R6	0757-0442		RESISTOR 10K 1% .125W F TC=0+-100	24546	C4-1/8-T0-1002-F
A7R7	0698-3155	2	RESISTOR 4.64K 1% .125W F TC=0+-100	24546	C4-1/8-T0-4641-F
A7R8	0698-3450	2	RESISTOR 42.2K 1% .125W F TC=0+-100	24546	C4-1/8-T0-4222-F
A7R9	0698-3450		RESISTOR 42.2K 1% .125W F TC=0+-100	24546	C4-1/8-T0-4222-F
A7R10	2100-3154		RESISTOR-TRMR 1K 10% C SIDE-ADJ 17-TRN	32997	3006P-1-102
A7R11	0757-0424	2	RESISTOR 1.1K 1% .125W F TC=0+-100	24546	C4-1/8-T0-1101-F
A7R12	0757-0419		RESISTOR 681 1% .125W F TC=0+-100	24546	C4-1/8-T0-681R-F
A7R13	0698-3152		RESISTOR 3.48K 1% .125W F TC=0+-100	24546	C4-1/8-T0-3481-F
A7R14	0698-3136		RESISTOR 17.8K 1% .125W F TC=0+-100	24546	C4-1/8-T0-1782-F
A7R15	0757-1094		RESISTOR 1.47K 1% .125W F TC=0+-100	24546	C4-1/8-T0-1471-F
A7R16	0757-0424		RESISTOR 1.1K 1% .125W F TC=0+-100	24546	C4-1/8-T0-1101-F
A7R17	0757-0438		RESISTOR 5.11K 1% .125W F TC=0+-100	24546	C4-1/8-T0-5111-F
A7R18	0698-3155		RESISTOR 4.64K 1% .125W F TC=0+-100	24546	C4-1/8-T0-4641-F
A7R19	0757-0198	1	RESISTOR 100 1% .5W F TC=0+-100	19701	MF7C1/2-T0-101-F
A7R20	0757-0442		RESISTOR 10K 1% .125W F TC=0+-100	24546	C4-1/8-T0-1002-F
A7R21	0698-3444	1	RESISTOR 316 1% .125W F TC=0+-100	24546	C4-1/8-T0-316R-F
A7R22	0757-0442		RESISTOR 10K 1% .125W F TC=0+-100	24546	C4-1/8-T0-1002-F
A7R23	0757-0442		RESISTOR 10K 1% .125W F TC=0+-100	24546	C4-1/8-T0-1002-F
A7R24	0757-0442		RESISTOR 10K 1% .125W F TC=0+-100	24546	C4-1/8-T0-1002-F
A7R25	0757-0442		RESISTOR 10K 1% .125W F TC=0+-100	24546	C4-1/8-T0-1002-F
A7R26	0757-0280		RESISTOR 1K 1% .125W F TC=0+-100	24546	C4-1/8-T0-1001-F
A7R27	2100-3154		RESISTOR-TRMR 1K 10% C SIDE-ADJ 17-TRN	32997	3006P-1-102
A7R28	0698-3154		RESISTOR 4.22K 1% .125W F TC=0+-100	24546	C4-1/8-T0-4221-F
A7R29	0698-3154		RESISTOR 4.22K 1% .125W F TC=0+-100	24546	C4-1/8-T0-4221-F
A7R30	0757-0280		RESISTOR 1K 1% .125W F TC=0+-100	24546	C4-1/8-T0-1001-F
A7R31	0757-0442		RESISTOR 10K 1% .125W F TC=0+-100	24546	C4-1/8-T0-1002-F
A7R32	0757-0438		RESISTOR 5.11K 1% .125W F TC=0+-100	24546	C4-1/8-T0-5111-F
A7R33	0757-0280		RESISTOR 1K 1% .125W F TC=0+-100	24546	C4-1/8-T0-1001-F
A7R34	0698-3434	2	RESISTOR 34.8 1% .125W F TC=0+-100	24546	C4-1/8-T0-348R-F
A7R35	2100-3164	1	RESISTOR-TRMR 10 20% C SIDE-ADJ 17-TRN	32997	3006P-1-100
A7R36	0698-3434		RESISTOR 34.8 1% .125W F TC=0+-100	24546	C4-1/8-T0-348R-F
A7R37	0757-1094		RESISTOR 1.47K 1% .125W F TC=0+-100	24546	C4-1/8-T0-1471-F
A7R38	0757-0438		RESISTOR 5.11K 1% .125W F TC=0+-100	24546	C4-1/8-T0-5111-F
A7R39	0698-0984	1	RESISTOR 2.15K 1% .125W F TC=0+-100	24546	C4-1/8-T0-2151-F
A7U1	1820-0616	1	IC-DIGITAL 9322DC TTL QUAD 2 2-TO-1-LINE	07263	9322DC
A7U2	1200-0507	1	SOCKET-IC 16-CONT DIP-SLDR-TERMS	06776	ICN-163-S3M
A7U3	1820-1216	1	IC-DIGITAL SN74LS138N TTL LS 3	01295	SN74LS138N
A7U3	1200-0507	1	SOCKET-IC 16-CONT DIP-SLDR-TERMS	06776	ICN-163-S3M
A7U3	1820-1277	1	IC-DIGITAL SN74LS192N TTL LS DECD	01295	SN74LS192N
A7U3	1200-0507	1	SOCKET-IC 16-CONT DIP-SLDR-TERMS	06776	ICN-163-S3M

See introduction to this section for ordering information

Table 6-2. Replaceable Parts

Reference Designation	HP Part Number	Qty	Description	Mfr Code	Mfr Part Number
A7U4	1820-0174 1200-0508	1	IC-DIGITAL SN7404N TTL HEX 1	01295	SN7404N
A7U5	1858-0632 1200-0508	1	SOCKET-IC 14-CONT DIP-SLDR-TERMS IC CA3146E XSTR ARRAY	06776 02735	ICN-143-S3W CA3146E
A7VR1 A7VR2	1902-0184 1902-3182		DIODE-ZNR 16.2V 5% DO-7 PD=.4W TC=+.066% DIODE-ZNR 12.1V 5% DO-7 PD=.4W TC=+.064%	04713 28480	SZ 10939-242 1902-3182
A7 MISCELLANEOUS					
	1251-0600		CONTACT-CONN U/W-POST-TYPE MALE DP-SLDR	28480	1251-0600
A8	08620-60013	1	BOARD ASSEMBLY, RECTIFIER	28480	08620-60013
A8C1	0160-0931	1	CAPACITOR-FXD .047UF +-20% 1000WVDC	84411	6630W473010W2
A8C2	0170-0040	1	CAPACITOR-FXD .047UF +-10% 200WVDC POLYE	56289	292P47392
A8C3	0160-2118	2	CAPACITOR-FXD .18UF +-10% 200WVDC POLYE	28480	0160-2118
A8C4	0160-2118		CAPACITOR-FXD .18UF +-10% 200WVDC POLYE	28480	0160-2118
A8CR1 A8CR2 A8CR3 A8CR4 A8CR5	1901-0418 1901-0418 1901-0418 1901-0418 1901-0418	16	DIODE-PWR RECT 400V 1.5A DIODE-PWR RECT 400V 1.5A DIODE-PWR RECT 400V 1.5A DIODE-PWR RECT 400V 1.5A DIODE-PWR RECT 400V 1.5A	04713 04713 04713 04713 04713	SR1846-12 SR1846-12 SR1846-12 SR1846-12 SR1846-12
A8CR6 A8CR7 A8CR8 A8CR9 A8CR10	1901-0418 1901-0418 1901-0418 1901-0418 1901-0418		DIODE-PWR RECT 400V 1.5A DIODE-PWR RECT 400V 1.5A DIODE-PWR RECT 400V 1.5A DIODE-PWR RECT 400V 1.5A DIODE-PWR RECT 400V 1.5A	04713 04713 04713 04713 04713	SR1846-12 SR1846-12 SR1846-12 SR1846-12 SR1846-12
A8CR11 A8CR12 A8CR13 A8CR14 A8CR15	1901-0418 1901-0418 1901-0418 1901-0418 1901-0418		DIODE-PWR RECT 400V 1.5A DIODE-PWR RECT 400V 1.5A DIODE-PWR RECT 400V 1.5A DIODE-PWR RECT 400V 1.5A DIODE-PWR RECT 400V 1.5A	04713 04713 04713 04713 04713	SR1846-12 SR1846-12 SR1846-12 SR1846-12 SR1846-12
A8CR16 A8CR17 A8CR18	1901-0418 1901-0025 1901-0025	2	DIODE-PWR RECT 400V 1.5A DIODE-GEN PRP 100V 200MA DO-7 DIODE-GEN PRP 100V 200MA DO-7	04713 28480 28480	SR1846-12 1901-0025 1901-0025
A8Q1	1854-0071		TRANSISTOR NPN SI PD=300MW FT=200MHZ	28480	1854-0071
A8R1 A8R2 A8R3 A8R4 A8R5	0698-0085 0698-0085 0757-0438 0757-0199 0757-0441	1	RESISTOR 2.61K 1% .125W F TC=0+-100 RESISTOR 2.61K 1% .125W F TC=0+-100 RESISTOR 5.11K 1% .125W F TC=0+-100 RESISTOR 21.5K 1% .125W F TC=0+-100 RESISTOR 8.25K 1% .125W F TC=0+-100	24546 24546 24546 24546 24546	C4-1/8-T0-2611-F C4-1/8-T0-2611-F C4-1/8-T0-5111-F C4-1/8-T0-2152-F C4-1/8-T0-8251-F
A8R6 A8R7	0757-0443 0757-0461	1	RESISTOR 11K 1% .125W F TC=0+-100 RESISTOR 68.1K 1% .125W F TC=0+-100	24546 24546	C4-1/8-T0-1102-F C4-1/8-T0-6812-F
A9	08620-60119	1	BOARD ASSEMBLY, SWITCH	28480	08620-60119
A9/A10	08620-60109		FRONT PANEL ASSEMBLY	28480	08620-60109
A10	08620-60120	1	BOARD ASSEMBLY, FRONT INTERFACE	28480	08620-60120
A10C1 A10C2 A10C3 A10C4 A10C5	0180-2141 0180-2205 0160-0163 0160-0155 0180-2205	2 2 1 1	CAPACITOR-FXD 3.3UF+-10% 50VDC TA CAPACITOR-FXD .33UF+-10% 35VDC TA CAPACITOR-FXD .033UF +-10% 200WVDC POLYE CAPACITOR-FXD 3300PF +-10% 200WVDC POLYE CAPACITOR-FXD .33UF+-10% 35VDC TA	56289 56289 56289 56289 56289	150D335X9050B2 150D334X9035A2 292P33392 292P33292 150D334X9035A2
A10C6 A10C7 A10C8	0180-2186 0180-0234 0180-2141	1 1	CAPACITOR-FXD 300UF+-20% 30VDC TA CAPACITOR-FXD 33UF+-20% 75VDC TA CAPACITOR-FXD 3.3UF+-10% 50VDC TA	56289 56289 56289	109D307X0030K2 109D336X0075F2 150D335X9050B2
A10CR1	1901-0050		DIODE-SWITCHING 80V 200MA 2NS DO-7	28480	1901-0050
A10R1 A10R2 A10R3 A10R4 A10R5	0757-0873 0757-0280 0698-6628 0698-8395 0811-1196	1 1 1 1	RESISTOR 1.62K 1% .5W F TC=0+-100 RESISTOR 1K 1% .125W F TC=0+-100 RESISTOR 500K .1% .125W F TC=0+-25 RESISTOR 50K .1% .25W F TC=0+-50 RESISTOR 5K .1% .062W PWR TC=0+-10	19701 24546 91637 19701 20940	MF7C1/2-T0-1624-F C4-1/8-T0-1001-F MFF-1/8-T9-5003-B MF52C1/4-T2-5002-B 114-1/16-5001-B
A10R6 A10R7	0698-0056 0698-3160	1 1	RESISTOR 931K 1% .5W F TC=0+-100 RESISTOR 31.6K 1% .125W F TC=0+-100	91637 24546	MFF-1/2-10 C4-1/8-T0-3162-F
A10XA9-1 A10XA9-2	08620-40013 08620-40013	2	CONNECTOR, PC SPACER CONNECTOR, PC SPACER	28480 28480	08620-40013 08620-40013
A11	08620-60121	1	BOARD ASSEMBLY, MOTHER	28480	08620-60121
A11C1 A11C2 A11C3 A11C4	0180-0453 0180-2603 0180-0452 0180-2604	1 1 1 1	CAPACITOR-FXD 8700UF+75-10% 40VDC AL CAPACITOR-FXD 7200UF+75-10% 50VDC AL CAPACITOR-FXD .013F+75-10% 25VDC AL CAPACITOR-FXD 1700UF+75-10% 100VDC AL	28480 28480 28480 28480	0180-0453 0180-2603 0180-0452 0180-2604

See introduction to this section for ordering information

Table 6-2. Replaceable Parts

Reference Designation	HP Part Number	Qty	Description	Mfr Code	Mfr Part Number
A11J1	1251-1968	1	CONNECTOR-PC EDGE 10-CONT/ROW 1-ROW	26742	91-6910-1700-00
A11J2	1251-2314	1	CONNECTOR-PC EDGE 10-CONT/ROW 2-ROWS	05574	3VH10/1JV5/079
A11XA1	1251-2134	5	CONNECTOR-PC EDGE 18-CONT/ROW 2-ROWS	71785	252-18-30-340
A11XA2	1251-2134		CONNECTOR-PC EDGE 18-CONT/ROW 2-ROWS	71785	252-18-30-340
A11XA3	1251-2134		CONNECTOR-PC EDGE 18-CONT/ROW 2-ROWS	71785	252-18-30-340
A11XA4	1251-1513	3	CONNECTOR-PC EDGE 18-CONT/ROW 1-ROW	90949	143-018-07-1158
A11XA5	1251-1513		CONNECTOR-PC EDGE 18-CONT/ROW 1-ROW	90949	143-018-07-1158
A11XA6	1251-2134		CONNECTOR-PC EDGE 18-CONT/ROW 2-ROWS	71785	252-18-30-340
A11XA7	1251-2134		CONNECTOR-PC EDGE 18-CONT/ROW 2-ROWS	71785	252-18-30-340
A11XA8	1251-1513		CONNECTOR-PC EDGE 18-CONT/ROW 1-ROW	90949	143-018-07-1158
A11 MISCELLANEOUS					
	0360-0111	10	STANDOFF-RVT-ON .25LG 6-32THD .2500 BR5	28480	0360-0111
A12	08620-60118	1	BOARD ASSEMBLY, HP-IB INTERFACE (OPTION 011)	28480	08620-60118
A12C1	0160-0575		CAPACITOR-FXD .047UF +-20% 50WVDC CER	28480	0160-0575
A12C2	0160-3879		CAPACITOR-FXD .01UF +-20% 100WVDC CER	28480	0160-3879
A12C3	0160-0570	1	CAPACITOR-FXD 220PF +-20% 100WVDC CER	28480	0160-0570
A12C4	0160-3879		CAPACITOR-FXD .01UF +-20% 100WVDC CER	28480	0160-3879
A12C5	0160-3878		CAPACITOR-FXD 1000PF +-20% 100WVDC CER	28480	0160-3878
A12CR1	1901-0539	1	DIODE-SCHOTTKY	28480	1901-0539
A12L1	9100-1627	1	COIL-WLD 39UH 5% Q=60 .155DX,375LG	24226	15/392
A12R1	0698-7229		RESISTOR 511 1% .05W F TC=0+-100	24546	C3-1/8-T0-511R-G
A12R2	0698-7236		RESISTOR 1K 1% .05W F TC=0+-100	24546	C3-1/8-T0-1001-G
A12R3	0698-7260		RESISTOR 10K 1% .05W F TC=0+-100	24546	C3-1/8-T0-1002-G
A12R4	0698-7224	1	RESISTOR 316 1% .05W F TC=0+-100	24546	C3-1/8-T0-316R-G
A12R5	0698-7223	2	RESISTOR 287 1% .05W F TC=0+-100	24546	C3-1/8-T0-287R-G
A12R6	0698-7223		RESISTOR 287 1% .05W F TC=0+-100	24546	C3-1/8-T0-287R-G
A12R7	0698-7243		RESISTOR 1.96K 1% .05W F TC=0+-100	24546	C3-1/8-T0-1961-G
A12R8	0698-7243		RESISTOR 1.96K 1% .05W F TC=0+-100	24546	C3-1/8-T0-1961-G
A12R9	0698-7243		RESISTOR 1.96K 1% .05W F TC=0+-100	24546	C3-1/8-T0-1961-G
A12R10	0698-7243		RESISTOR 1.96K 1% .05W F TC=0+-100	24546	C3-1/8-T0-1961-G
A12R11	2100-3103		RESISTOR-TRMR 10K 10% C SIDE-ADJ 17-TRN	32997	3006P-1-103
A12R12	2100-3103		RESISTOR-TRMR 10K 10% C SIDE-ADJ 17-TRN	32997	3006P-1-103
A12SW1	3101-1860	1	SWITCH-SL 5-1A-NS DIP-SLIDE-ASSY .1A	11237	206 TYPE
A12U1	1820-1197		IC-DIGITAL SN74LS00N TTL LS QUAD 2 NAND	01295	SN74LS00N
A12U2	1820-1197		IC-DIGITAL SN74LS00N TTL LS QUAD 2 NAND	01295	SN74LS00N
A12U3	1820-1112	3	IC-DIGITAL SN74LS74N TTL LS DUAL	01295	SN74LS74N
A12U4	1820-1112		IC-DIGITAL SN74LS74N TTL LS DUAL	01295	SN74LS74N
A12U5	1820-0904	1	IC-DIGITAL 93L24DC TTL L MAGTQ	07263	93L24DC
A12U6	1820-1112		IC-DIGITAL SN74LS74N TTL LS DUAL	01295	SN74LS74N
A12U7	1820-1196	6	IC-DIGITAL SN74LS174N TTL LS HEX	01295	SN74LS174N
A12U8	1820-1196		IC-DIGITAL SN74LS174N TTL LS HEX	01295	SN74LS174N
A12U9	1820-1198	2	IC-DIGITAL SN74LS03N TTL LS QUAD 2 NAND	01295	SN74LS03N
A12U10	1820-1201		IC-DIGITAL SN74LS08N TTL LS QUAD 2 AND	01295	SN74LS08N
A12U11	1820-1197		IC-DIGITAL SN74LS00N TTL LS QUAD 2 NAND	01295	SN74LS00N
A12U12	1820-1196		IC-DIGITAL SN74LS174N TTL LS HEX	01295	SN74LS174N
A12U13	1820-1196		IC-DIGITAL SN74LS174N TTL LS HEX	01295	SN74LS174N
A12U14	1820-1198		IC-DIGITAL SN74LS03N TTL LS QUAD 2 NAND	01295	SN74LS03N
A12U15	1820-1212		IC-DIGITAL SN74LS112N TTL LS DUAL	01295	SN74LS112N
A12U16	1820-1201		IC-DIGITAL SN74LS08N TTL LS QUAD 2 AND	01295	SN74LS08N
A12U17	1820-1196		IC-DIGITAL SN74LS174N TTL LS HEX	01295	SN74LS174N
A12U18	1820-1196		IC-DIGITAL SN74LS174N TTL LS HEX	01295	SN74LS174N
A12U19	1820-1522	4	IC-DIGITAL MC3440P TTL* QUAD	04713	MC3440P
A12U20	1820-1522		IC-DIGITAL MC3440P TTL* QUAD	04713	MC3440P
A12U21	1820-1522		IC-DIGITAL MC3440P TTL* QUAD	04713	MC3440P
A12U22	1820-1522		IC-DIGITAL MC3440P TTL* QUAD	04713	MC3440P
A12U23	0960-0447		4 BCD DIGITAL	28480	0960-0447
A12U24	1818-2269	1	IC, MOS ROM	28480	1818-2269
	1200-0553	1	SOCKET-IC 28-CONT DIP-SLDR	28480	1200-0553
A12VR1	1902-0041		DIODE-ZNR 5.11V 5% DO-7 PD=.4W TC=-.009%	15818	CD 35622
A12 MISCELLANEOUS					
	1251-1556		CONNECTOR-SGL CONT SKT .018-IN-89C-SZ	28480	1251-1556
91	3160-0217	1	FAN BLADE .76-TMK 3-OD .079-ID	28480	3160-0217
91	3140-0490	1	MOTOR, DC	28480	3140-0490
91	1251-1115	1	POLARIZING KEY-PC EDGE CONN	28480	1251-1115

See introduction to this section for ordering information

Table 6-2. Replaceable Parts

Reference Designation	HP Part Number	Qty	Description	Mfr Code	Mfr Part Number
DS1	2140-0312	5	LAMP-INCAND 7683AS15 5VDC 60MA T-1-BULB	71744	CM7-7683AS15
DS2	2140-0312		LAMP-INCAND 7683AS15 5VDC 60MA T-1-BULB	71744	CM7-7683AS15
DS3	2140-0312		LAMP-INCAND 7683AS15 5VDC 60MA T-1-BULB	71744	CM7-7683AS15
DS4	2140-0312		LAMP-INCAND 7683AS15 5VDC 60MA T-1-BULB	71744	CM7-7683AS15
DS5	2140-0312		LAMP-INCAND 7683AS15 5VDC 60MA T-1-BULB	71744	CM7-7683AS15
DS6	2140-0244	1	LAMP-GLOW A1H 65/105VDC 1MA T-2-BULB	28480	2140-0245
F1	2110-0003	1	FUSE 3A 250V FAST-BLO 1.25X.25 UL IEC	75915	312003,
F1	2110-0043	1	FUSE 1.5A 250V FAST-BLO 1.25X.25 UL IEC	75915	31201.5
F1	2110-0332	1	FUSE 3A 125V NORM-BLO .25X.27	71400	GMW 3
FL1	0960-0448	1	LINE MODULE FILTER	28480	0960-0448
J1	1251-0118	1	CONNECTOR 6-PIN M CIRC K	71468	WK-6-32S
J2	1251-4222	1	CONNECTOR	28480	1251-4222
J3	1250-0118	4	CONNECTOR-RF BNC FEM SGL-HOLE-FR 50-OHM	24931	28JR128-1
J4	1250-0118	1	CONNECTOR-RF BNC FEM SGL-HOLE-FR 50-OHM	24931	28JR128-1
J5	1250-0118	1	CONNECTOR-RF BNC FEM SGL-HOLE-FR 50-OHM	24931	28JR128-1
J6	1251-3066	1	CONNECTOR 36-PIN F MICRO RIBBON	90949	222-42-36-058
J7	1251-2447	1	CONNECTOR-PC EDGE 84-CONT/RDW 2-ROWS	05574	3VH44/1JN5
J9MP1	1250-0118	1	CONNECTOR-RF BNC FEM SGL-HOLE-FR 50-OHM	24931	28JR128-1
J9MP2	1251-0196	1	CONNECTOR-PC EDGE 6-CONT/RDW 2-ROWS	71765	251-06-30-261
	5040-0327	1	HOOD:CONNECTOR	28480	5040-0327
	2200-0109	2	SCREW-MACH 4-40 .438-IN=LG PAN-HD-POZI	28480	2200-0109
J2MP1	08620-20082	1	SHROUD, CONNECTOR	28480	08620-20082
Q1	1853-0059	2	TRANSISTOR PNP 2N3791 SI TO-3 PD=150W	04713	2N3791
Q2	1854-0063	1	TRANSISTOR NPN 2N3055 SI TO-3 PD=115W	28480	1854-0064
Q3	1853-0059	1	TRANSISTOR PNP 2N3791 SI TO-3 PD=150W	04713	2N3791
Q4	1854-0080	1	TRANSISTOR NPN SI TO-3 PD=100W FT=3MHZ	28480	1854-0080
R1	0698-3449		RESISTOR 29.7K 1% .125W F TC=0+-100	24546	C4-1/8-T0-2672-F
R2	2100-2867	2	RESISTOR-VAR PREC WW 5-TRN 10K STD=88HG	28480	2100-2867
R3	2100-2865	2	RESISTOR-VAR PREC WW 3-TRN 1K 3%	28480	2100-2865
R4	2100-2866	1	RESISTOR-VAR PREC WW 5-TRN 2K 3%	28480	2100-2866
R5	2100-2865	1	RESISTOR-VAR PREC WW 3-TRN 1K 3%	28480	2100-2865
R6	2100-2867		RESISTOR-VAR PREC WW 5-TRN 10K STD=88HG	28480	2100-2867
R7	2100-2937	2	RESISTOR-VAR CONTROL CC 1K 10% LIN	01121	w
R8	2100-2937		RESISTOR-VAR CONTROL CC 1K 10% LIN	01121	w
S1	3101-1395	1	SWITCH-PB DPDT-DB ALING 10.5A 250VAC	00501	53-67280-121/A1H
S2	3101-0859	2	SWITCH-SENS SPDT SUBMIN .14 125VAC	01963	E63-17K
S3	3101-0859		SWITCH-SENS SPDT SUBMIN .1A 125VAC	01963	E63-17K
S4	3101-1081	5	SWITCH-SENS SPDT SUBMIN .5A 30VDC	91929	113M23
S5	3101-1081		SWITCH-SENS SPDT SUBMIN .5A 30VDC	91929	113M23
S6	3101-1081		SWITCH-SENS SPDT SUBMIN .5A 30VDC	91929	113M23
S7	3101-1081		SWITCH-SENS SPDT SUBMIN .5A 30VDC	91929	113M23
S8	3101-1081		SWITCH-SENS SPDT SUBMIN .5A 30VDC	91929	113M23
S9	3101-0070	3	SWITCH-SL DPDT-NS MINTR .5A 125VAC/DC	79727	GF-126-0000
S10	3101-0070		SWITCH-SL DPDT-NS MINTR .5A 125VAC/DC	79727	GF-126-0000
S11	3101-0070		SWITCH-SL DPDT-NS MINTR .5A 125VAC/DC	79727	GF-126-0000
T1	9100-3841	1	TRANSFORMER, POWER	28480	9100-3841
W1	08620-60083	1	CABLE ASSEMBLY, POWER	28480	08620-60083
W2	08620-60085	1	CABLE ASSEMBLY, FLEX	28480	08620-60085
W3	8120-1348	1	CABLE ASSY 18AWG 3-CNDCT BLK-JKT .253-OD	28480	8120-1348
W4	08620-60105	1	WIRING HARNESS, FRONT	28480	08620-60105
W5	08620-60107	1	WIRING, HARNESS, MOTOR	28480	08620-60107
MISCELLANEOUS PARTS					
	0380-0643	1	STANDOFF, LG STUD MOUNT(METRIC THREAD) (P/O 08620-60130 CONNECTOR/ADAPTER FOR OPTION 011)	0046A	08D#
	0360-0268	1	TERMINAL-SLDR LUG LK-MTG FOR-#6-SCR	78189	2103-06-00
	0380-0921	2	SPACER-RND .45LG .086ID .312OD AL ALDN	28480	0380-0921
	0380-1036	2	SPACER-HEX .255LG 6-32THD .312A/F STL NI	28480	0380-1036
	0590-0053	4	NUT-SHMET-J 6-32-THD .5-WD STL	78553	C17859-632-240
	1200-0043	4	INSULATOR-XSTR ALUMINUM	76530	522047
	2360-0115	1	SCREW-MACH 6-32 .312-IN=LG PAN-HD-POZI	28480	2360-0115
	2420-0001	1	NUT-HEX-W/LKWR 6-32-THD .109-THK	28480	2420-0002
	2510-0184	1	SCREW-MACH 8-32 .562-IN=LG 82 DEG	28480	2510-0184
	7120-2359	1	SERIAL PLATE .625-IN=WD 1.5-IN=LG AL	28480	7120-2359
	9223-0040	4	PST-PAK POLYETH RND 10.75=LG 4=0IA	28480	9223-0040
	08620-00019	2	BRACKET, FAN	28480	08620-00019
	08620-00074	2	SHIELD, FAN BLADE	28480	08620-00074
	08620-20072	1	STRIP FILLER	28480	08620-20072
	08620-20122	1	BOARD, CONNECTOR	28480	08620-20122
	08620-60108	1	PANEL ASSEMBLY, REAR	28480	08620-60108
	08620-60109	2	PANEL ASSEMBLY, FRONT	28480	08620-60109
	08620-60123	1	ACCESSORY KIT	28480	08620-60123

See introduction to this section for ordering information

Table 6-3. Code List of Manufacturers

Mrf No.	Manufacturer Name	Address	Zip Code
00000	U.S.A. Common	Any supplier of the U.S.	
0018A	AR Tech Packaging Corp.	Lowell, Ma.	01854
0046A	ADAC Screw Machine Products		
00501	Illuminated Products Inc.	Anaheim, Ca	92803
00779	AMP Inc.	Harrisburg, Pa	17105
01121	Allen-Bradley Co.	Milwaukee, Wi	53212
01295	Texas Instrument Inc., Semicond Cmpnt Div.	Dallas, Tx	75231
01686	RCL Electronics Inc.	Manchester, NH	03102
01963	Cherry Electrical Products Corp.	Waukegan, Il	60085
02735	RCA Corp Solid State Div.	Sommerville NJ	08876
03877	Transitron Electronic Corp.	Wakefield, Ma	01880
03888	KDI Pyrofilm Corp.	Whippany, NJ	07981
04713	Motorola Semiconductor Products	Phoenix, Az	85008
05574	Viking Industries Inc.	Chatsworth, Ca	91311
06776	Robinson Nugent Inc.	New Albany, In	47150
07263	Fairchild Semiconductor Div.	Mountain View, Ca	94040
07716	TRW Inc. Burlington Div.	Burlington, Ia	52601
11237	CTS Keene Inc.	Paso Robles, Ca	93446
11502	TRW Inc. Boone Div.	Boone, Nc	28607
14140	Edison Elek. Div. McGraw-Edison	Manchester, NH	03130
15818	Teledyne Semiconductor	Mountain View, Ca	94040
19701	Mepco/Electra Corp.	Mineral Wells, Tx	76067
20940	Micro-Dhm Corp.	El Monte, Ca.	94731
24226	Gowanda Electronics Corp.	Gowanda, NY	14070
24546	Corning Glass Works (Bradford)	Bradford, Pa	16701
24931	Specialty Connector Co. Inc.	Indianapolis, In	46227
26742	Methode Electronics Inc.	Chicago, Il	60656
27014	National Semiconductor Corp.	Santa Clara, Ca	95051
28480	Hewlett-Packard Co. Corporate HQ	Palo Alto, Ca	94304
30983	Mepco/Electra Corp.	San Diego, Ca	92121
32997	Bourns Inc. Trimptod Prod. Div.	Riverside, Ca	92507
56289	Sprague Electric Co.	North Adams, Ma	01247
70472	Associated Spring Corp.	Bristol, Ct	06010
71400	Bussman Mfg. Div. of McGraw-Edison Co.	St. Louis, Mo	63017
71468	ITT Cannon Electric Co.	Santa Ana, Ca	92702
71744	Chicago Miniature/Drake	Chicago, Il	60640
71785	TRW Elek Components Cinch Div.	Elk Grove Village, Il	60007
72962	Esna, Div. of Amerace Corp.	Union, NJ	07083
73138	Beckman Instruments Inc. Helipot Div.	Fullerton, Ca	92634
75042	TRW Inc. Philadelphia Div.	Philadelphia, Pa	19108
75915	Littlefuse Inc.	Des Plaines, Il	60016
76530	TRW Elek Cmpnt Cinch-Monadnock Div.	City of Industry, Ca	91747
78189	Illinois Tool Works Inc. Shakeproof	Elgin Il.	60126
78553	Tinnerman Products Inc.	Cleveland, Oh	44129
79136	Waldes Kohinoor Inc.	Long Island City, NY	11101
79727	C-W Industries	Cleveland, Oh	44129
79963	Zierick Mfg Co.	Mt. Kisco, NY	10549
80120	Schnitzer Alloy Products Co.	Elizabeth, NJ	07206
81150	Cemco Mfg. Co., OEM Sales Div.	Columbus, Oh	43201
84411	TRW Capacitor Div.	Ogallala, Ne	69153
90949	Amphenol Sales Div. of Bunker-Ramo	Hazelwood, Mo	63042
91637	Dale Electronics Inc.	Columbus, Ne	68601
91929	Honeywell Inc. Micro Switch Div.	Freeport, Il	61032
97464	Industrial Retaining Ring Co.	Irvington, NJ	07111
99800	Amer Prcn Ind. Inc. Delevan Div.	Aurora, NY	14052

REPLACEABLE FRONT PANEL PARTS

Reference Designation	HP Part Number	Qty	Description	Mfr Code	Mfr Part Number
1	08620-40006	1	WHEEL, RETAINING	28480	08620-40006
2	1480-0072	2	PIN, ROLL .062 DIA X .375" LG	72962	92-012-062-0375
3	08620-20067	2	ARM, LATCH	28480	08620-20067
4	0624-0227		SCREW, MACHINE PAN HD POZI DR, 4-40 THD, .25" LG	28480	0624-0227
5	2190-0019		WASHER, LOCK, NO 4, .115" ID	28480	2190-0019
6	08620-00014	5	ARM, PIVOT	28480	08620-00014
7	08620-20021	1	SHAFT, DRUM	28480	08620-20021
8	08620-00057	1	BRACKET, MICROSWITCH, BAND	28480	08620-00057
9	08620-00017	2	SPRING, PUSHBUTTON	28480	08620-00017
10	2360-1022	5	SCREW, FH 6-- 32X 0.500" LG.	28480	2360-1022
11	08620-00015	1	BRACKET, LEFT HAND NOTCH	28480	08620-00015
12	08620-00058	1	HINGE	28480	08620-00058
13	08620-00016	1	BRACKET, RIGHT HAND NOTCH	28480	08620-00016
14	08620-00013	5	PLATE, NUT, SWITCH	28480	08620-00013
15	08620-20022	5	PLUNGER, PUSHBUTTON	28480	08620-20022
16	0520-0137	12	SCREW, MACHINE: 2-56, .75" LG, PAN HD	28480	0520-0137
17	3050-0098	8	WASHER, FLAT 2.094 ID .25 OD	80120	AN960 C2
18	2190-0112	13	WASHER, LOCK, NO 2, .088 ID	28480	2190-0112
19	0520-0129	1	SCREW, MACHINE: 2-56, .312" LG, PAN HD	28480	0520-0129
20	3050-0098		WASHER, FLAT 2.094 ID .25 OD	80120	AN960 C2
21	2190-0112		WASHER, LOCK HELICAL: 2.088 ID .175	28480	2190-0112
22	08620-20063	1	NUT, SPRING	28480	08620-20063
23	08620-20065	1	SPACER, SPRING	28480	08620-20065
24	1460-0534	1	SPRING, TORSION	28480	1460-0534
25	08620-40005	1	WHEEL, CAM	28480	08620-40005
26	2200-0105	2	SCREW, MACHINE: 4-40, .312" LG, PAN HD	28480	2200-0105
27	08620-40004	1	FLIPPER, DRUM	28480	08620-40004
28	08620-20057	1	PIN, STEP	28480	08620-20057
29	1460-1163	1	SPRING, COMPRESSION	28480	1460-1163
30	0510-0082	1	RING, RETAINING, .125 DIA BE CU	97464	3190-12-BC
31	0510-0055	5	RING, RETAINING, .438 DIA	0018A	1400-43-CD
32	08620-40008	1	WASHER, STOP, KEYED	28480	08620-40008
33	08620-40009	1	WASHER, STOP, UNKEYED	28480	08620-40009
34	3050-0127	5	WASHER, SPRING, WAVY, 7/16, .44" ID	70472	R4
35	0520-0137		SCREW, MACHINE 2-56, .75" LG, PAN HD	28480	0520-0137
36	3050-0098		WASHER, FLAT 2.094 ID .25 OD	80120	AN960 C2
37	2190-0112		WASHER, LOCK: HELICAL 2.088 ID .175	28480	2190-0112
38	08620-60044	1	FULL SWP DRIVE BELT & POINTER REPL ASSY	28480	08620-60044
39	08620-60046	1	CW DRIVE BELT & POINTER REPL ASSY	28480	08620-60046
40	08620-60047	2	CW VERNIER DRIVE BELT & POINTER REPL ASSY	28480	08620-60047
41	08620-60045	1	MARKER SWP DRIVE BELT & POINTER REPL ASSY	28480	08620-60045
42	1450-0707	5	LAMPHOLDER	28480	1450-0707
43	08620-40012	3	SPROCKET, 10 TOOTH	28480	08620-40012
44	08620-20030	28	ROLLER, BELT	28480	08620-20030
45	08620-20025	5	SCREW, ADJUST	28480	08620-20025
46	08620-20031	5	ROLLER, ADJUSTING	28480	08620-20031
47	2190-0014	5	WASHER, LOCK, INT TOOTH, NO 2, .089" ID	28480	1902-00
48	0610-0001	5	NUT, HEX, 2-56 THD, .062" THK	28480	0610-0001
49	08620-40011	2	SPROCKET, 7 TOOTH	28480	08620-40011
50	08620-20017	1	FRAME, DIAL	28480	08620-20017
51	08620-60047	1	ΔF, DRIVE BELT & POINTER REPL ASSY	28480	08620-60047
52	08620-20122	1	BRACKET, PC BOARD	28480	08620-20122
53	08620-20071	1	FRAME, PANEL	28480	08620-20071
54	08620-20068	1	ROD, LATCH	28480	08620-20068
55	0510-0060	1	RING, RETAINING, .375" DIA	79136	5655-37-S-MD
56	08620-00007	1	BRACKET, BOARDS	28480	08620-00007
57	08620-00020	1	GUARD, FAN	28480	08620-00020
58	08620-00059	1	HANDLE, LATCH	28480	08620-00059
59	2360-0195	1	SCREW, PAN HD POZI DR, 6-32 THD, .312" LG	28480	2360-0195
60	2190-0018	1	WASHER, LOCK, NO 6, .141" ID	28480	2190-0018
61	3050-0066	1	WASHER, FLAT, NO 6, .147" ID	28480	3050-0066
62	1460-0535	1	SPRING, LATCH HANDLE	28480	1460-0535
63	08620-20062	1	SCREW, LATCH, BEARING	28480	08620-20062
64	08620-20061	1	BEARING, LATCH	28480	08620-20061
65	3030-0195	5	SCREW, SET, 2-66 THD, .094" LG	28480	3030-0195
66	08620-00021	1	SCALE, 0 - 10V CALIBRATE (P/O ACCESSORIES SUPPLIED)	28480	08620-00021
67	08620-20069	1	SUPPORT, LEFT, LATCH ROD	28480	08620-20069
68	08620-00061	1	PLATE, NUT, LEFT	28480	08620-00061
69	2360-0124	2	SCREW, NUT PLATE, LEFT, 6-32 THD, .625" LG	28480	2360-0124
70	2950-0001	4	NUT, HEX, 3/8-32 THD, .094" THK	12697	2014-13
71	2190-0016	8	WASHER, LOCK, STAR, INT TOOTH, NO 3/8, .377 ID	78189	1920-02
72	0360-1190	4	LUG, GROUND, 3/8 SCREW, .38" X .078" ID	79963	720-380H
73	0380-0093	4	STANDOFF, HEX, .3" LG, 6-32 THD	81150	R370-E
74	08620-20070	1	SUPPORT, RIGHT, LATCH ROD	28480	08620-20070
75	08620-00062	1	PLATE, NUT, RIGHT	28480	08620-00062
76	2360-0211	2	SCREW, NUT PLATE, RIGHT, 6-32 THD, .75" LG	28480	2360-0211
77	08620-40010	5	KNOB, PUSHBUTTON, WHITE	28480	08620-40010
78	0370-1375	5	KNOB, ROUND, JADE GRAY (STD.)	28480	0370-1375
79	5040-0345	2	INSULATOR, CONNECTOR	28480	5040-0345
80	0370-1001	2	KNOB, RND, JADE GRAY FOR 0.125" DIA SHAFT	28480	0370-1001
81	08620-20072	1	FILLER STRIP, PLASTIC	28480	08620-20072

Figure 6-1. Front Panel Assembly, Parts Locations (1 of 4)

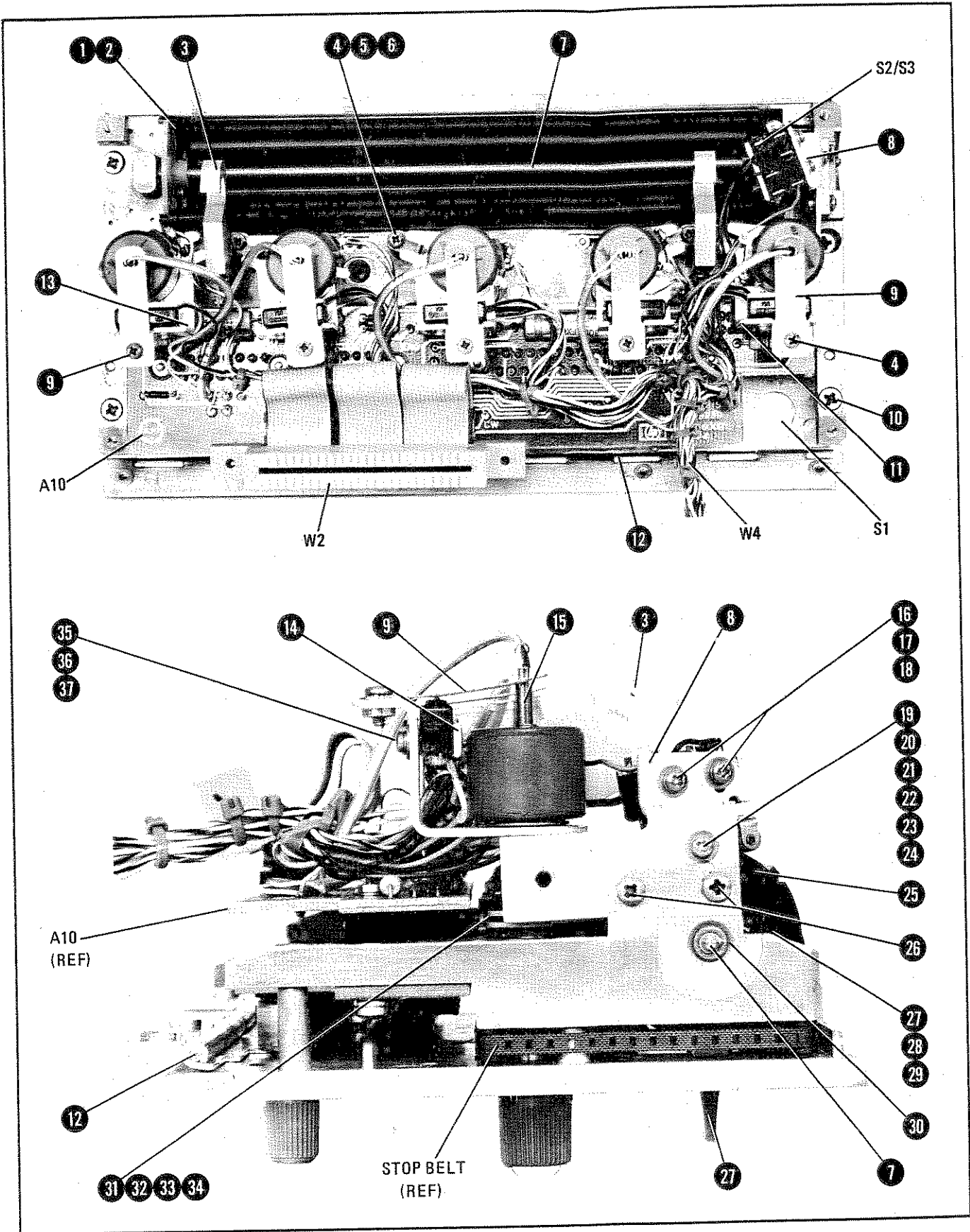

Figure 6-1. Front Panel Assembly, Parts Locations (2 of 4)

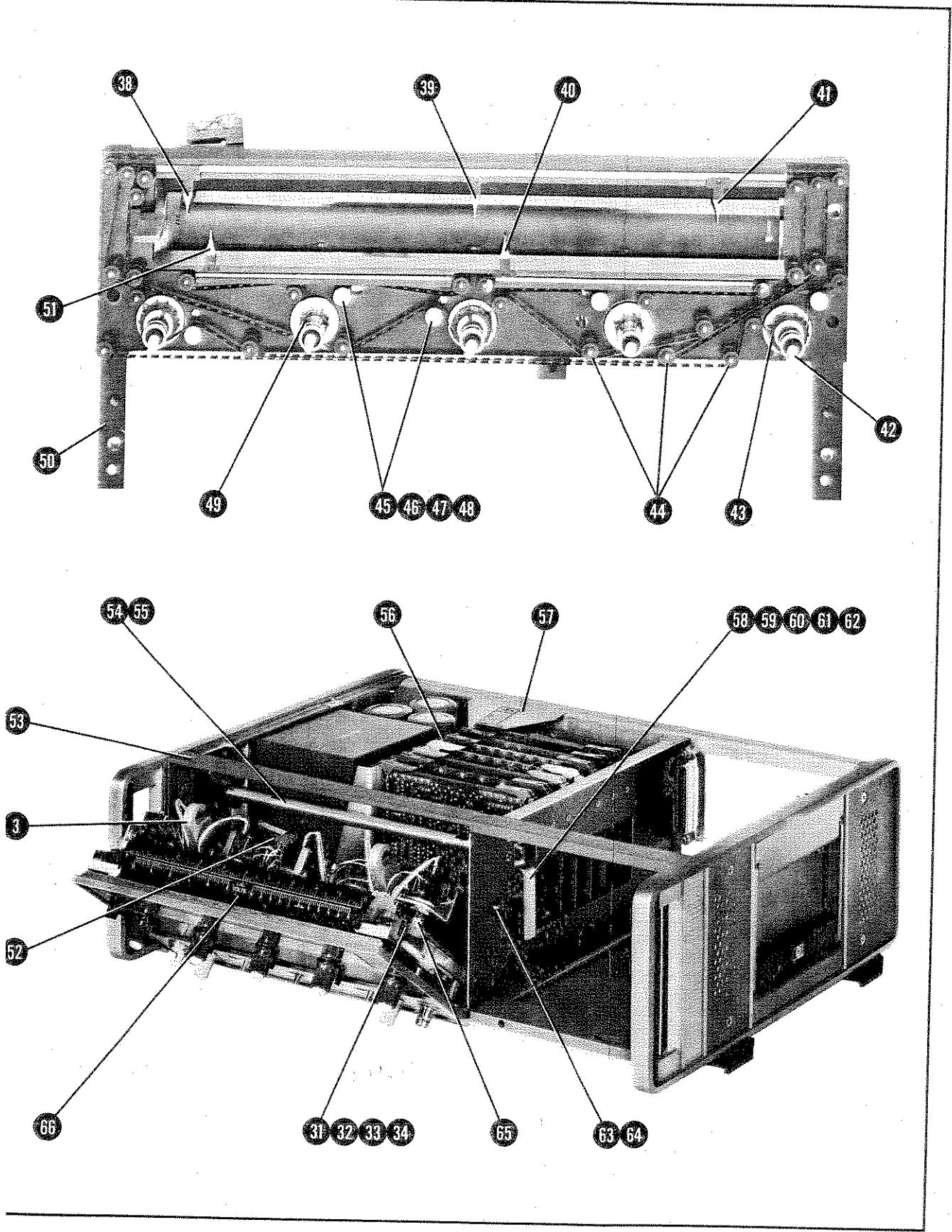

Figure 6-1. Front Panel Assembly, Parts Locations (3 of 4)

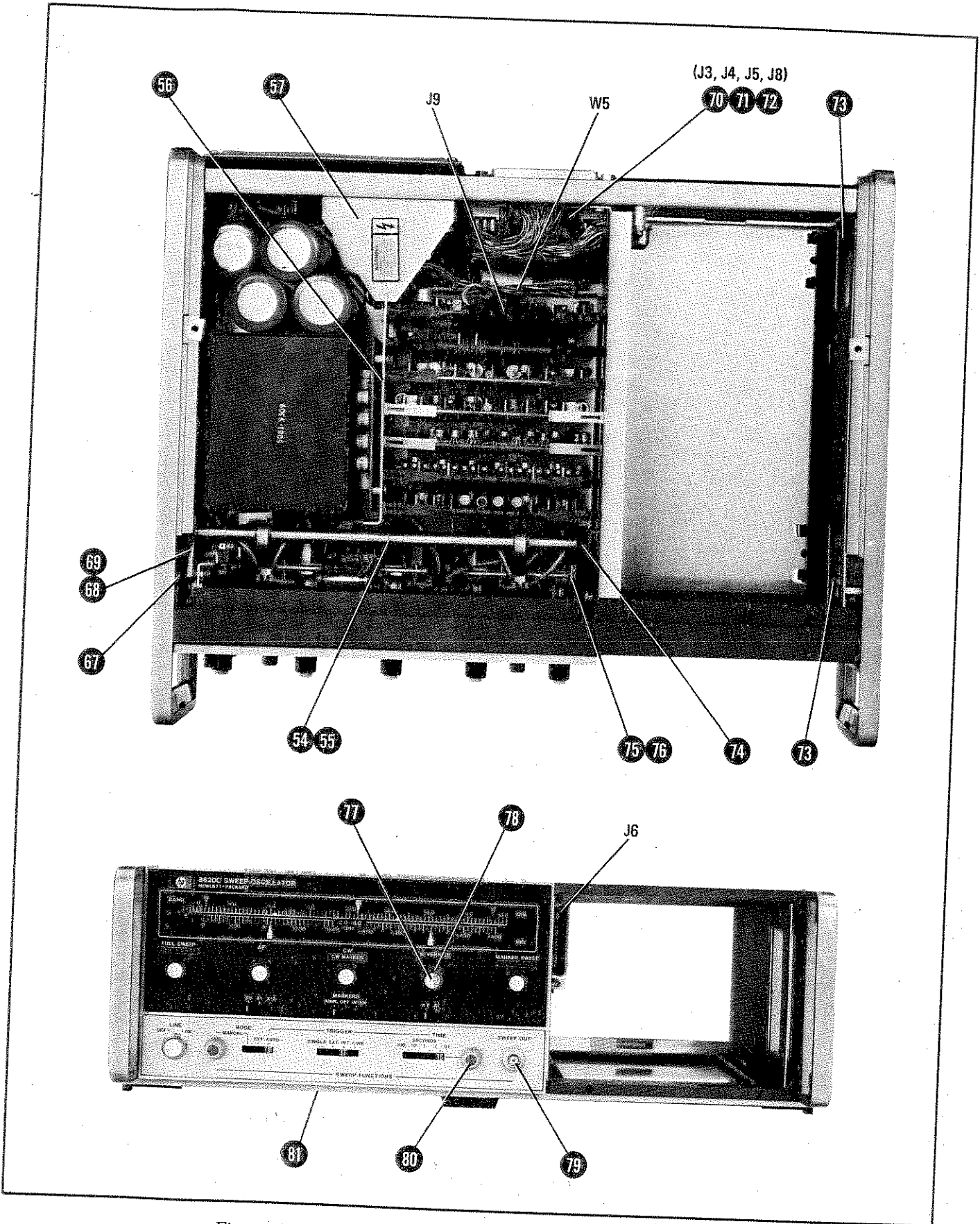

Figure 6-1. Front Panel Assembly, Parts Locations (4 of 4)

SECTION VII MANUAL BACKDATING CHANGES

7-1. INTRODUCTION

7-2. This manual has been written for and applies directly to instruments with serial numbers prefixed as indicated on the title page. Earlier versions of the instrument (serial number prefixes lower than the one indicated on the title page) may be slightly different in design or appearance. The purpose of this section of the manual is to document these differences. With the information provided in this section, this manual can be corrected so that it applies to any earlier version or configuration of the instrument. Later versions of the instrument (serial number prefixes higher than the

one indicated on the title page) are documented in a yellow Manual Changes Supplement.

7-3. To adapt this manual to your instrument, refer to Table 7-1 and make all manual changes listed opposite your instrument serial number. Perform these changes in the sequence listed.

7-4. If your instrument serial number is not listed on the title page of this manual or in Table 7-1, it will be documented in a yellow Manual Changes Supplement. Complimentary copies of this supplement are available through your nearest Hewlett-Packard office. Addresses are provided at the rear of this manual.

Table 7-1. Manual Changes by Serial Number

Serial Prefix or Number	Make Manual Changes
1645A	A
1641A	A, B
1626A	A, B, C
1604A	A, B, C, D
1542A00311 through 1542A00350	A, B, C, D, E
1542A00151 through 1542A00310	A, B, C, D, E, F
1537A	A, B, C, D, E, F, G

7-5. MANUAL CHANGE INSTRUCTIONS

CHANGE A

Page 6-11, Table 6-2:

Change A5R9 HP Part Number to 2100-3154 and Description to 1K OHMS.

Page 8-25, Figure 8-21, SERVICE SHEET 7:

Change A5R9 value to 1K.

CHANGE B

Page 6-7, Table 6-2:

Change A3C5, A3C9, A3C10, and A3C11 to HP Part Number 0160-3878, CAPACITOR-FXD, 1000 PF.

Page 8-21, Figure 8-17, SERVICE SHEET 5:

Change A3C5, A3C9, A3C10, and A3C11 values to 1000 pF.

MANUAL BACKDATING CHANGES

CHANGE C

Page 6-4, Table 6-2:

Delete A1C7.

Page 8-15, Figure 8-10, SERVICE SHEET 2:

Replace Figure 8-10 with Figure 7-1.

Page 8-17, Figure 8-12, SERVICE SHEET 3:

Replace Figure 8-12 with Figure 7-2.

Page 8-17, Figure 8-13, SERVICE SHEET 3:

Delete A1C7.

CHANGE D

Page 6-11, Table 6-2:

Change A7 HP Part Number to: 08620-60117.

NOTE

Instruments with serial prefixes 1604A and lower were equipped with the 08620-60117 A7 Operations Control Assembly, however, the 08620-60137 is the recommended replacement and is directly interchangeable.

Page 6-12, Table 6-2:

Delete A7C11.

Delete A7Q19.

Delete A7Q20.

Change A7R8 to 0757-0459, RESISTOR 56.2K, 1%, .125W.

Change A7R9 to 0698-3260, RESISTOR 464K, 1%, .125W.

Change A7R10 to 2100-3109, RESISTOR-TRMR 2K, 10%, SIDE ADJUST, 17-TURN.

Change A7R11 to 0698-0084, RESISTOR 2.15K, 1%, .125W.

Change A7R12 to 0698-3444, RESISTOR 316 OHMS, 1%, .125W.

Change A7R16 to 0757-0416, RESISTOR 511 OHMS, 1%, .125W.

Change A7R17 to 0698-0082, RESISTOR 464 OHMS, 1%, .125W.

Delete A7R37.

Delete A7R38.

Delete A7R39.

Page 8-31, SERVICE SHEET 10:

Replace Figure 8-27 with Figure 7-3.

Replace applicable part of Figure 8-28 with Figure 7-4.

CHANGE E

Page 6-15, Table 6-2:

Delete HP Part Number 0380-0643, STANDOFF, HEX HEAD, P/O 08620-60130 CONNECTOR/ADAPTER FOR OPTION 011.

MANUAL BACKDATING CHANGES

CHANGE E (cont'd):**NOTE**

The above mentioned part was not installed on instruments with serial numbers prefixed 1552A and lower, however it is recommended that the part number not be deleted from the replaceable parts list as this part is necessary for operation of HP-IB instruments.

CHANGE F

Page 6-9, Table 6-2, after last A3 entry:

Add HP Part Number 8159-0005, WIRE, 22AWG, PVC, 1X22, 80C.

NOTE

This wire jumper switches in the CW Filter in Remote D/A Tuning Mode. It was deleted as an instrument improvement modification. It is recommended that this wire jumper not be installed.

Page 6-11, Table 6-2:

Add after A6U2, A6U3, and A6U4: 1200-0508, SOCKET, IC, 14-CONT.

Page 6-14, Table 6-2:

Change J2MP1 HP Part Number to 08620-00073.

CHANGE G

Page 5-2, Figure 5-1:

Replace Figure 5-1 with Figure 7-5.

Page 5-6, Paragraph 5-16:

Change Procedure Step a to read: Connect oscilloscope Channel A to A7TP6 (Q5 collector) and Channel B to Q7 collector. Connect oscilloscope ground lead to A7TP7.

Page 5-7, Figure 5-4:

Change title on bottom waveform to read: CHANNEL B, (Q7 COLLECTOR).

Page 8-31, SERVICE SHEET 10:

Replace Figure 8-27 with Figure 7-6.

In Figure 8-28, change A7TP8 to A7TP7 and delete A7TP7 at Q7 collector.

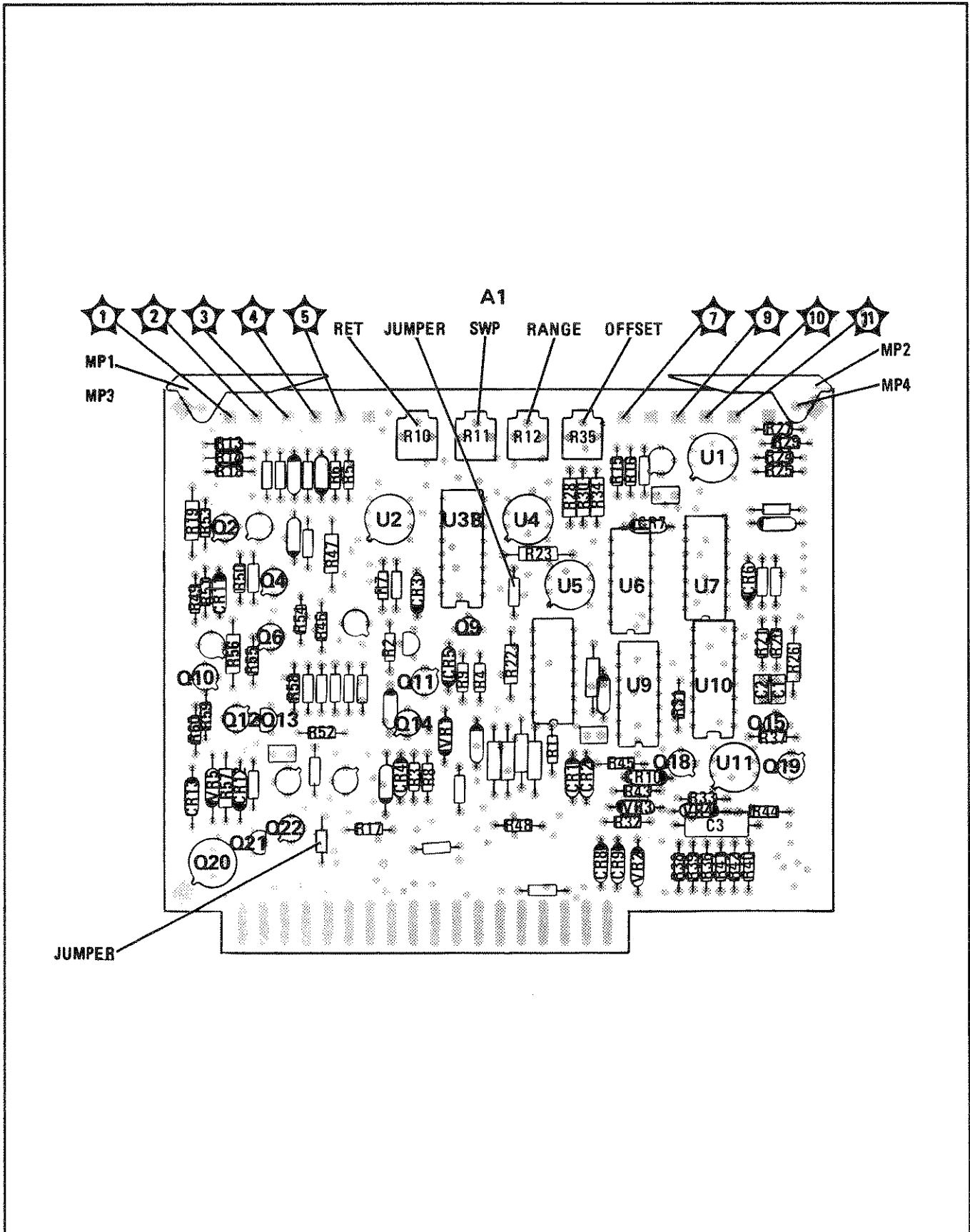

Figure 7-1. A1 Sweep Generator Assembly, Component Locations (CHANGE C) (1 of 2)

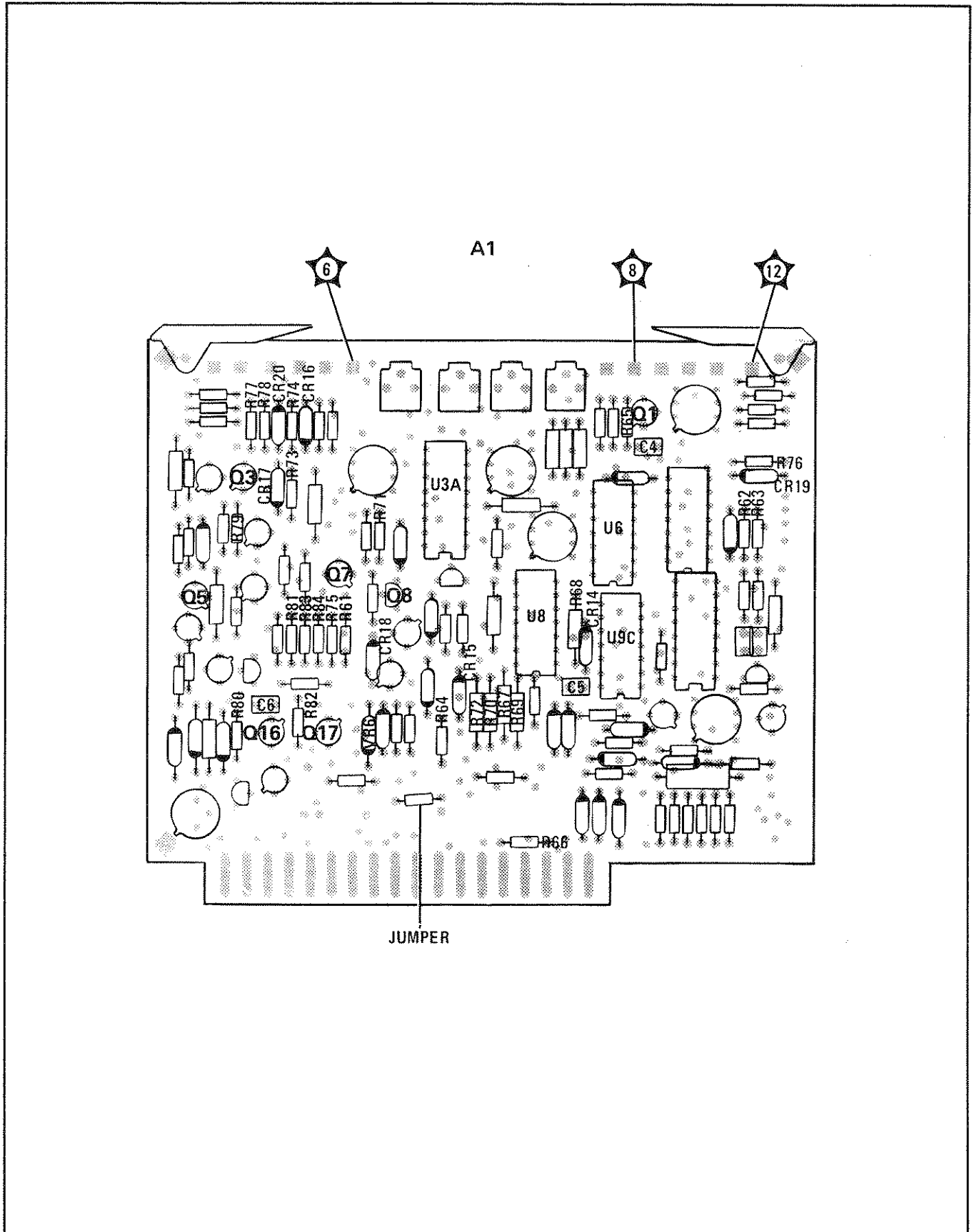

Figure 7-2. A1 Sweep Generator Assembly, Component Locations (CHANGE C) (2 of 2)

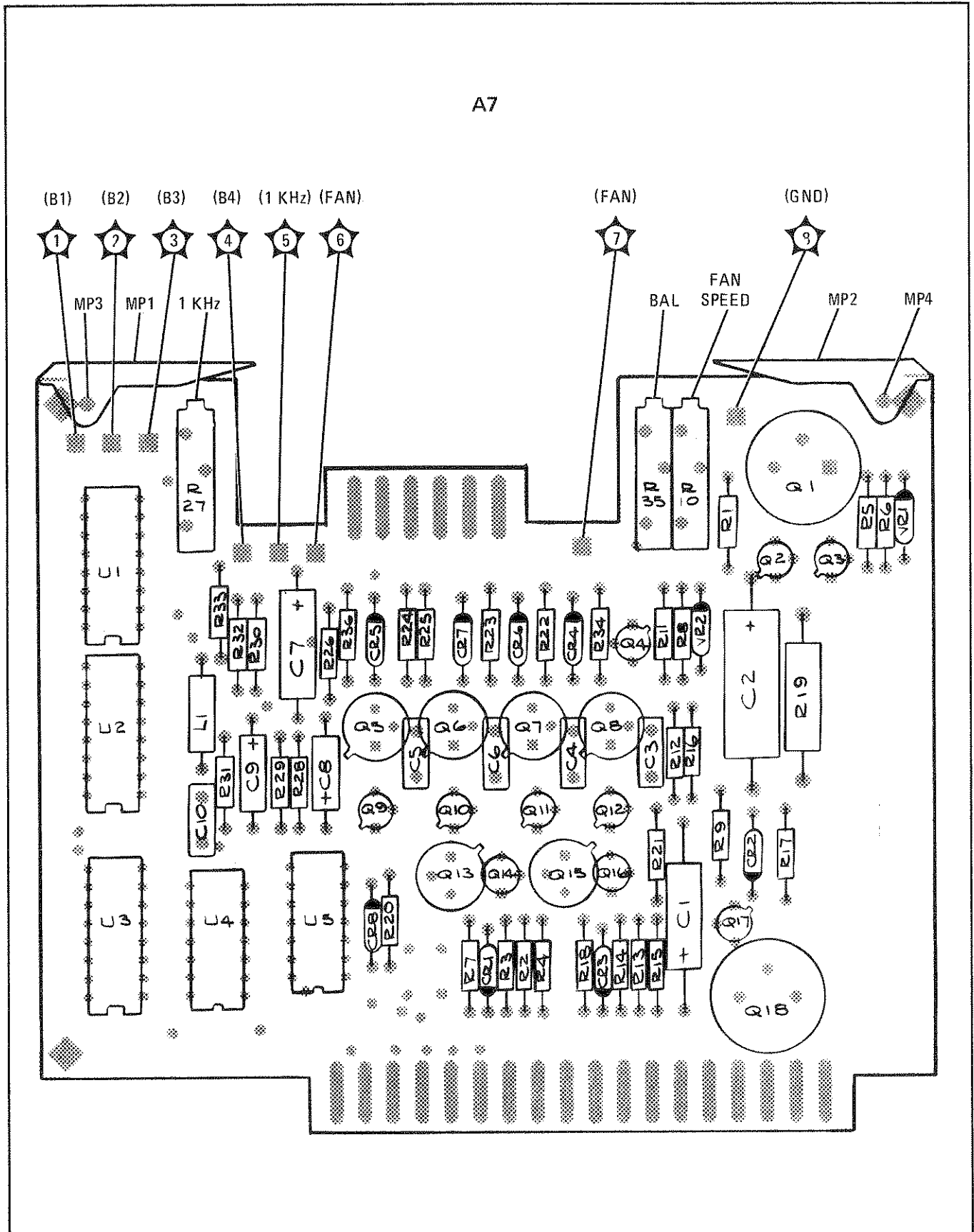

Figure 7-3. A7 Operations Control Assembly, Component Locations (CHANGE D)

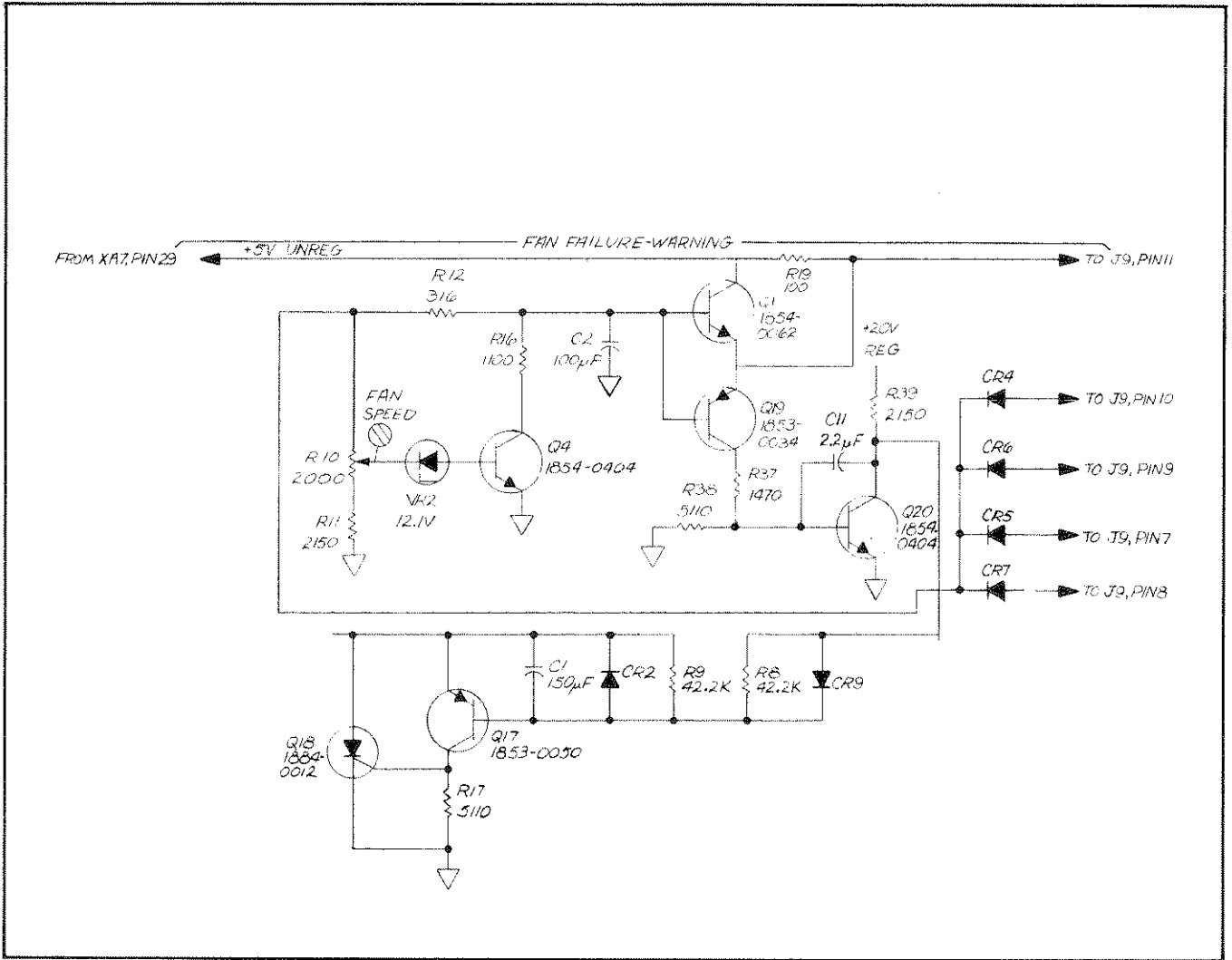

Figure 7-4. P/O Figure 8-28. A7 Operations Control Assy. Schematic (Change D)

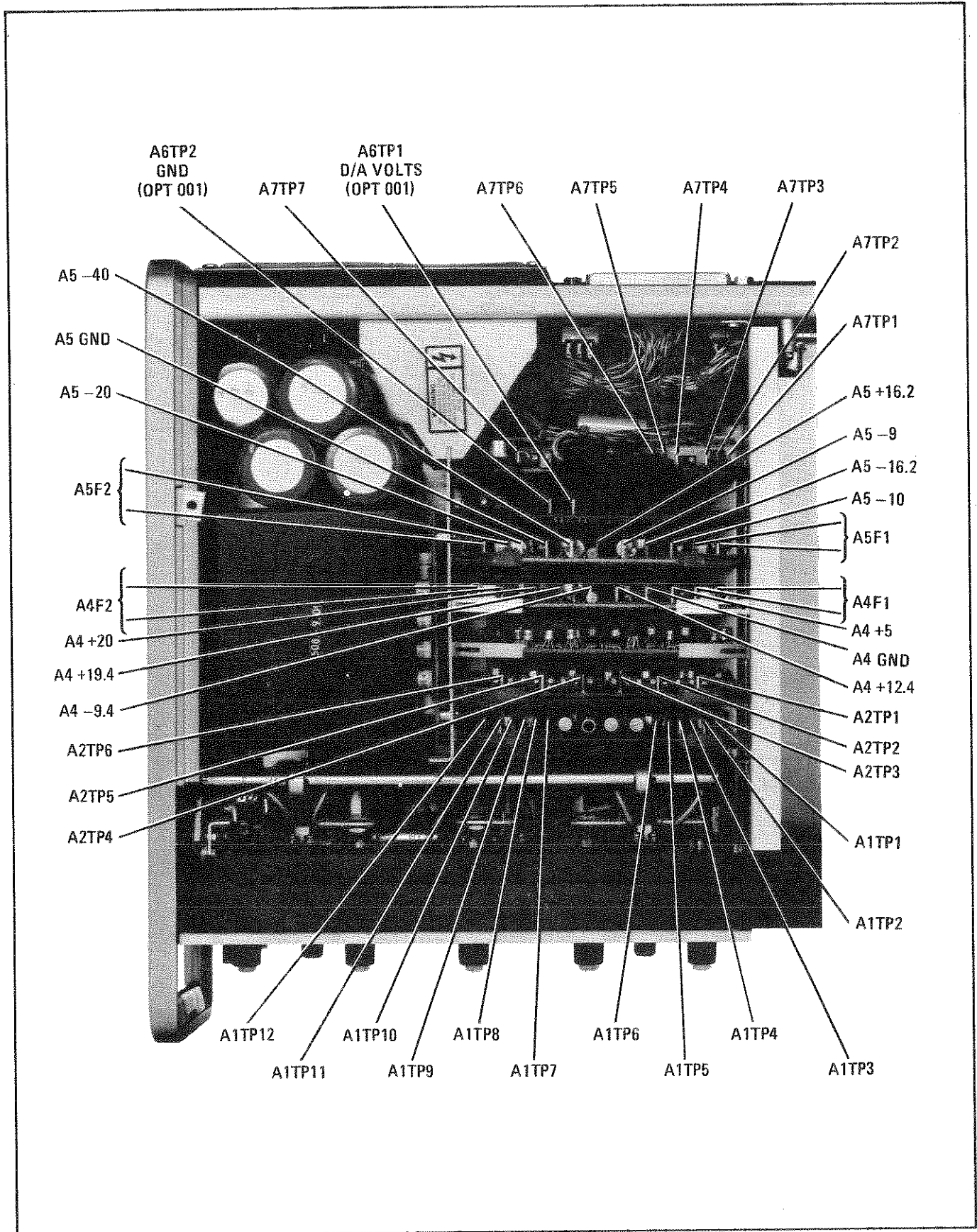

Figure 7-5. Location of Test Points (P/O Change G)

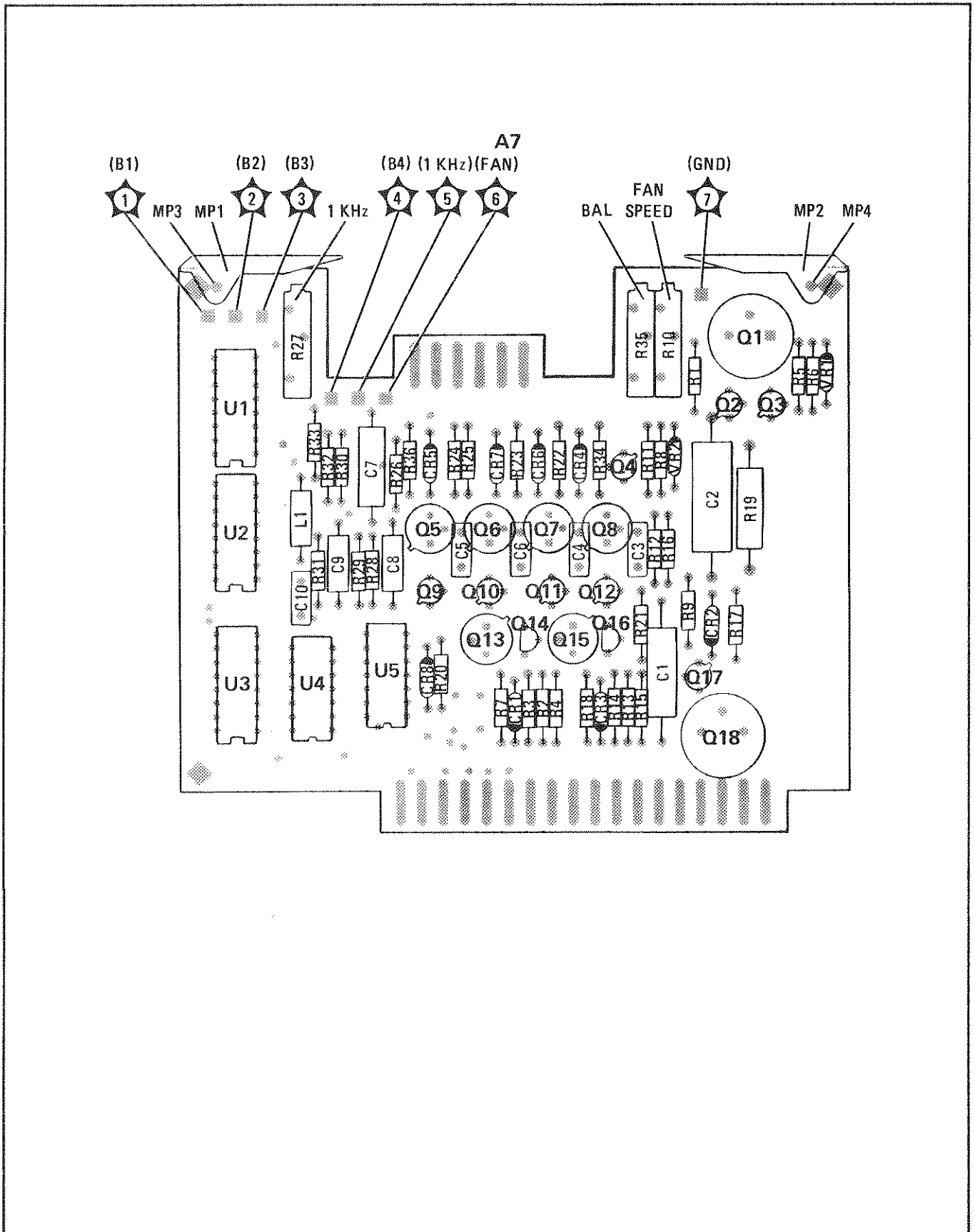

Figure 7-6. A7 Operations Control Assembly, Component Locations (P/O Change G)